

CAMBRO®



2 0 0 9 P R O D U C T C A T A L O G

2009 CAMBRO® CATALOG TABLE OF CONTENTS



TRAYS

TABLE SERVICE

DISPLAY

STORAGE

7-29

30-45

46-57

59-107

Trays At A Glance	8-9
Century Camtrays®	10-11
Camtrays®	12-17
Dietary Trays	15
V-Series Tray	15
Color Chart	16-17
Personalization	18
Camwear® Trays	19
Camlite® Trays	19
Market Trays & Pans	20
Fast Food Trays	21
Camtread® Trays	22
Camtread® Trays Designer Series	23
Polytread® Trays	24
School Compartment Trays	25-26
Compartment Serving Trays	27
Trapezoid Compartment Trays	27
Meal Delivery Trays	28
Separator® Compartment Trays	28
Tray On Tray System	29

Personalization	31
Dinnerware	32-33
Camwear® Heat Keepers	33
Meal Delivery System	34
Camcover® Plate Covers	35-36
Pitchers	37
Aliso® Barware	38
Goblets	38
Tumblers	39-43
Camliters®/Decanters	43
6-Gallon Beverage Dispenser	44
Pail with Bail	44
Swirl Bowls	44
Wine Buckets	45
Punch Bowls	45
Bud Vase	45

Deli Crocks & Platters	47
ShowFest® Display Bowls & Trays	48
Market Trays & Pans	49
Serving Bowls	50-52
Display Covers & Trays	53
Crocks	54
Ladles	54
Serving Spoons	55
High Heat Camtensils®	55
Tongs	56
Shakers/Dredges	57
Condiment Jars	57

Camshelving®	59-76
Consulting Service	61
Components	62
Space Utilization	63
High Density	64
Configuration Details	65
Post Kits	66
Shelf Kits	67
Starter Units	68-71
Add-On Units	68-71
Mobile Post Kits	72
Mobile Starter Units	73-74
Security Cage	75
Dome Drying and Storage Cart	75
Wall Shelves & Extenders	76
Dunnage Racks	77
Pizza Dough Boxes	77
StoreSafe® Labels	78
Quick Guide To Storage Solutions	79
Food Storage Containers	80-87
CamSquares®	80-83
Storage Containers	80-83
Round Storage Containers	84-87
Food Storage Boxes & Lids	88-91
Food Pans At A Glance	92
Camwear® Food Pans & Lids	93-97
H-Pans™	98-101
Guide to Food Pan Covers	102
ColdFest®	103
Translucent	104-105
Ingredient Bins	106
Camcrisper®	106
Scoops	107
Measuring Cups	107

InStock

Cambro's top selling and most frequently used products are InStock. These products are available to ship to Certified Cambro Distributors with their next shipment. Broken cartons are excluded. InStock products are highlighted in gray throughout the Cambro Product Catalog.



MERCHANDISING

108-126

CamKiosk®	109-110
Work Station	111
Equipment Stands	111
Hand Sink Cart	111
Camcruiser® Vending Carts	112-113
Versa Organizers	114
Booster Seats	114
Food Bars	115-118
Portable CamBars®	119-125
Ice Caddies	126

INSULATED TRANSPORT

127-158

CamServers®	129
Handwash Accessories	129
Ultra Camtainers®	130-131
Camtainers®	130-131
Condiment Holder	130-131
Risers	130-131
Easy Serve Dispenser	131
S-Series Ultra Pan Carriers®	132-133
Ultra Pan Carriers	132-133
Camcarriers®	132-133, 136-139
Camchiller®	134-135
ThermoBarrier®	134-135
Camwarmer®	134-135
Ultra Camcarts®	140-141
H-Series Ultra Pan Carriers	142-144
Transporter Capacity Guide	145
Camtherm® Bulk Food Holding Cabinets	146-150
Combo Carts™	151
Camcarts®	152-153
Beverage Service Cart	154
Meal Delivery Carts	156-158

CAMRACK® WAREWASHING

159-186

Utility Cart	161
Service Carts	161-162
Cambox® Bus Boxes	163
Camdollies®	164-166
Utility Trucks	166
Tray & Dish Cart	167
Tray & Silver Cart	167
Dish Caddies	168-170
Camracks®	171-186
Camdolly & Camrack Cover	180
Selecting the Right Camrack	180
Component System	181-182
Personalization	183-184
Sizing & Reference Guide	185-186

GENERAL INFORMATION

187-207

www.cambro.com	6
General Terms	6
Icon Directory	6
Cambro Sales Representatives	187-192
Alpha Numeric Listing	193-205
Warranty	205
Roto Color Chart	207

PERSONALIZATION

Camtrays	18
Fast Food Trays	21
Table Service/Storage	31
CamKiosk	110
Camcruisers	113
Camracks	183-184

2009 CAMBRO® CATALOG ALPHABETICAL INDEX

Bars, Portable Beverage	119-125	Mobile Post Kits	72	Cups/Mugs	33	Sink Cart	111
Aliso® Barware	38	Mobile Starter Units	73-74	Goblets	38	Six Gallon Dispenser	44
Beverage Servers	128-131	Post Kits	66	Tumblers	39-43	Slant Top Ingredient Bins	106
Beverage Service Carts	154	Starter Units	68-71	Dunnage Racks	77	SlidingLids™	88, 90
Bins		Security Cage	75	Equipment Stands	111	Sneeze Guards	116, 118
Organizer Bins	114	Shelf Kits	67	FlipLids®	93, 97, 101-102	Spatulas/Turners	55
Ingredient Bins	106	Wall Shelves	76	Food Bars	115-118	Spoons	55
Vegetable Bin/Crisper	106	Camtainers®	130-131	Food Pans	92-105	Square Food Storage Containers	80-83
Booster Seats	114	Camtensils®	55	Food Storage Containers	80-87	Swirl Bowls®	44
Bowls		Camtherm® Cabinets	146-150	Glass Keepers	176	Temperature Maintenance	134-135
Dinnerware	32-33	Camwarmers®	134-135	Goblets	38	ThermoBarriers®	134-135
Salad/Serving	50-52	Carafes, Camliter Decanter	43	GripLids®	97, 102	Tongs	56
Boxes		Carts		Hand Sink Carts	111	Trays	
Dish/Bus Boxes	151	Beverage Service Cart	154	Hand Wash Accessories	129	Century Camtray®	10-11
Food Storage Boxes	88-91	Camtherm Cart	146-150	Heat Keepers/Insulated Covers	33	Camlite® Trays	19
Pizza Dough Boxes	77	Combo Carts	151	Hot/Cold Carts	146-150	Camtray® Trays	12-17
Bud Vases	45	Hot/Cold Carts	146-150	Ice Caddies	126	Camtread® Trays	22
Buffet Bars	115-118	Insulated Carts	140-144, 151-153	Ingredient Bins	106	Camwear® Trays	19
CamBars	119-125	Insulated Tray & Food Box Carts	152-153	Insulated Coffee Servers	129-131	Compartment Trays	25-27
Camboxes®	151	Meal Delivery Carts	155-158	Insulated Pan Carriers	132-133, 136-139	Dietary Trays	15
Camcarriers®	132-133, 136-139	Service Carts	160-162	Kiosk Vending	109-110	Fast Food Trays	21
Camcarts®	152-153	Tray & Dish/Silver Carts	167	Labels, Dissolvable	78	Market Trays	20, 49
Camchillers®	134-135	Vending Carts	109-110, 112-113	Ladles	54	Meal Delivery Trays	28
Camcrispers®	106	Coffee Service	129-131, 154	Securing Strap	136, 139	Personalization	18, 21
Camcovers®/Plate Covers	35-36	Colanders	89, 91, 96, 100	Market Trays & Pans	20, 49	Polytread® Trays	24
Camdollies®	164-166, 180	ColdFest® Food Pans	103	Meal Delivery Carts	155-158	School Compartment Trays	25-26
CamKiosk® System	109-111	Cold Packs	124-125	Meal Delivery System	34	V-Series Trays	15
Camlitters®	43	Color Charts		Measuring Cups	107	Tumblers	39-43
Camracks®	171-186	CamKiosk	110	Mugs, Dinnerware	33	Ultra Pan Carriers®	132-133, 136-139
Base Racks	177	Camracks	173, 175, 177, 179	Organizers, Condiment	114, 131	Ultra Camtainers®	130-131
Camrack Cover	180	Camtrays®	16-17	Pail with Bail	44	Ultra Camcarts®	140-141
Component System	181-182	Camwear® Dinnerware	32	Pans, Food	92-105	Utensils	55
Cup Racks	176	Portable Bars	121	Pitchers	37	Utility Carts	161
Flatware Racks	178	Vending Carts	110, 112	Pizza Dough Boxes	77	Utility Trucks	166
Full Size Racks	173-174	Roto Color Chart	207	Plates, Dinnerware	33	Vegetable/Produce Crispers	106
Half Size Racks	175	Combo Carts™	151	Plate Covers/Camcovers	35-36	Vending Carts	109-110, 112-113
Open End Tray Racks	178	Condiment Jars	57	Punch Bowls	45	Wine Buckets	45
Peg Racks	178	Crocks	54	Risers	131	Work Stations	111
Personalization	183-184	Cups, Dinnerware	33	Round Food Storage Containers	84-87	General Information	
PlateSafe™	179	Cup Keepers	176	Salad/Serving Bowls	48-50	Alpha Numerical Listing	193-205
Reference Guides/Sizing	185-186	Decanters, Camliter Carafes	43	Saucers, Dinnerware	33	Cambro Representatives	187-192
Selecting the Right Camrack	180	Deli Crocks & Platters	47	Scoops	107	General Terms	6
CamServers®	129	Dinnerware	32-33	Service Carts	160-162	Icon Directory	6
Camshelving®	59-76	Dish Caddies	169-170	Shakers/Dredges	57	Merchandising & Equipment	
Accessories	66	Dish Racks	171-186	Shelving	59-76	Color Chart	207
Add-On Units	68-71	Dispensers, Beverage	44	ShowFest® Bowls & Display Trays	48		
Casters/Donut Bumper	72	Display Covers/Trays	53				
Components	62	Dollies	164-166, 180				
Consulting Service	61	Drain Shelves	89, 91, 95, 99, 105				
Corner Connector Set	66	Drinkware					
Dunnage Stand	66	Barware	38				
Fence System	74						
Configuration Details	65						



THE CAMBRO® STORY

Cambro was founded by two brothers, Bill and Argyle Campbell in 1951 when Bill invented the Camtray® and Argyle began selling the tray to the American Hospital Supply Corporation. The Camtray was quickly embraced by restaurant, hotel, school, and cafeteria operators, and it became the industry standard. Growing from this heritage, today we offer the most complete line of sizes, shapes, colors and materials in foodservice trays throughout the world.

Bill's creativity was the driving force behind new product development. During the 1960's, Cambro introduced Camcover® plate covers, drinkware, dinnerware and serving bowls to provide operators with long lasting tableware and serving items. Cambro also created the first plastic food pan and the first clear food storage container.

Cambro combined plastic molding with foam insulation in the early 1970's to create the first Camtainer®. This was the

beginning of our full line of insulated food and beverage containers that keep hot food hot or cold food cold for holding, transporting and catering.

Our tradition of innovation continues to this day. Every Cambro product is engineered to help foodservice operators increase sales and profits, reduce labor and improve safety. This has led us to industry innovations in storage, such as the FlipLid®, GripLid®, and SlidingLid™; in merchandising with the CamKiosk® and portable CamBars®; and with revolutionary products like the Camrack® closed-wall warewashing system, Camshelving® and thermoelectric Camtherm® holding cabinets.

In the late eighties, Cambro began to export. Cambro acquired Presswerk Kongen in 1997 and Ozay Manufacturing in 2004. We now manufacture a number of our products overseas to be marketed throughout Europe and Asia, respectively. All our products are available worldwide, and a global approach is a significant

part of our growth strategy.

Over the last fifty-eight years, Cambro has grown from one product, the Camtray, to thousands of products; from one salesman to a global sales and distribution network; from two presses in a small shop to a number of manufacturing capabilities around the world. Despite this extensive growth, we remain committed to creating and providing the most durable and highest quality products for the foodservice industry. And Argyle Campbell, the late Bill Campbell's son, stands at the helm of Cambro to continue the Campbell brothers' vision.

Visit www.cambro.com for a wide variety of information about our products including new product updates, an interactive Camrack Glass to Rack Guide, consultant cut sheets and CAD drawings, care and maintenance product guides and more.

GENERAL TERMS

Cambro products may be combined to obtain prepaid freight because they are manufactured in one area.

Specifications, features and equipment shown are based upon the latest information available. Cambro Manufacturing Company reserves the right to make changes at any time, without notice, to price, colors, specifications, accessories and materials. For additional information, please contact your authorized Cambro representative.

Freight

Freight is free on shipments totaling \$3,000 net or more, based on a single order for single delivery within the continental U.S.A. Orders for shipments totaling less than \$3,000 are F.O.B. Cambro warehouse of origin. Any items back ordered from a "free freight order" will be forwarded transportation charges paid. Add-ons are not allowed on "free freight order backorders". Customer requested palletized orders will be charged \$7.00 net per pallet.

Return Merchandise Policy

No merchandise may be returned without written authorization. Authorized returns must be shipped freight prepaid. All returned goods must be new and unused, in original packaging and are subject to a minimum 15% repackaging charge plus outbound freight. Returned goods must be received within 60 days of purchase. Special or non-standard items are not returnable.

Assessorial Charges

From time to time, motor carriers will charge for services that are beyond the scope of a normal delivery. In the event that this happens, Cambro Mfg. reserves the right to bill the customer for these charges. Services that fall under this program would include:

- Sort & Segregation of product at customer's dock
- Lift-gate required to off load the product from the truck
- Inside delivery requests

These charges are considered to be assessorial charges and are not included in the prepaid freight program.

Broken Cartons

Orders calling for less than standard pack will be charged \$10.00 net per broken case. Broken cartons are not available on any special order items, the assortment pack, custom imprinted ladles or on StoreSafe labels. There is no broken carton charges on Camracks.

Replacement Parts

Visit www.cambro.com for replacement parts information on Cambro products.

Product Accessories

Contents and accessories shown in photos are not included, except where noted.

ICON DIRECTORY

Throughout the Cambro catalog, please use the following easy-to-identify icons to help explain Cambro product features or services.

STORESAFE®

Cambro is committed to providing food service operators with products to help meet HACCP guidelines.

- Cambro food storage products are designed to help keep food fresh and reduce cross contamination.
- Camshelving® is easy to clean to provide a sanitary storage area.
- Cambro catering and merchandising equipment maintain food temperatures to safely hold and transport food.
- The closed wall design of the Camrack® Warewashing and Storage System allows glassware to be stored in an enclosed sanitary place.

Look for the Cambro StoreSafe mark throughout the Cambro catalog to identify Cambro storage and transportation products that help ensure safe food handling.



Store and Transport
Food Safely



Listed by the National Sanitation Foundation. NSF, an independent testing organization, lists products which meet their criteria for sanitation and cleanability



New Product



Dishwasher Safe



5-Year Warranty

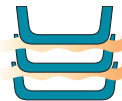

Stackable



Foam Insulation



Personalization Available
Non-Food Contact Areas Only



One carton of product is within the weight and cube requirements to be shipped by parcel carrier

Note: Temperature ranges noted throughout this catalog are based on specific test criteria and provide a general guideline. Individual use may vary due to differences in loading temperatures or ambient temperature.

TRAYS

- Century Camtrays®
- Camtrays®
- Dietary Trays
- Metric Camtrays
- V-Series Tray
- Camtray Colors & Patterns
- Camtray Personalization
- Camwear® Trays
- Camlite® Trays
- Market Trays & Pans
- Fast Food Trays & Personalization
- Camtread® Trays
- Camtread Trays Designer Series
- Polytread® Trays
- School Compartment Trays
- Compartment Serving Trays
- Trapezoid Compartment Trays
- Meal Delivery Trays
- Separator® Compartment Trays
- Tray On Tray Meal Delivery System

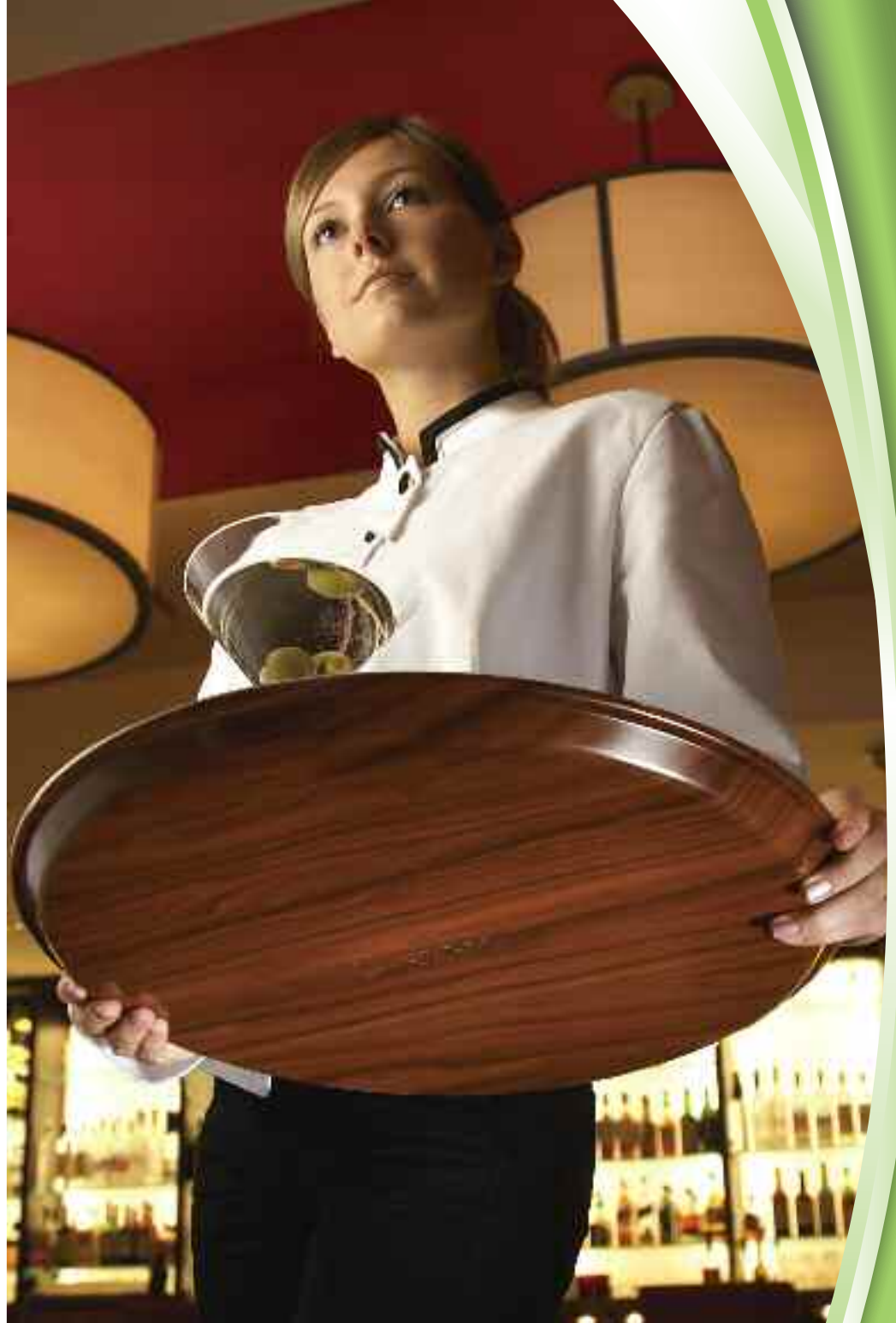

PATRON TRAYS

Century Camtray®

Sleek, contemporary design with low edges allows increased user comfort while dining. Durable fiberglass construction.



Camtray®

The industry standard. Durable fiberglass construction backed by a 5 year guarantee against breakage.



Camlite®

Combine economy with durability. Fiberglass construction.



Camwear®

Made from virtually unbreakable Camwear polycarbonate.



Fast Food

Economical choice that withstands frequent use.



NON-SLIP SERVICE TRAYS

Camtread® & Designer Series Camtread

Durable fiberglass construction with non-skid surface. Grips service items to avoid spills. 5 year guarantee.



Polytread®

General purpose tray with non-skid surface.



SCHOOL COMPARTMENT

2 x 2 Compartment

Durable trays with easy grip handles. Trays fit side by side in dishrack to reduce warewashing expense.



DISPLAY AND OPS

Market

Ideal for merchandising food items in showcases. Durable fiberglass construction.



V-Series

All purpose tray assists in kitchen. Ideal for pre-portioning ingredients or prep work.



School Compartment Trays

Six compartment tray available in three materials.



CORRECTIONAL COMPARTMENT TRAYS

Trapezoid and Compartment Serving Trays

Deep compartments for ample servings and portion control.



Separator® Compartment Trays

Tray and cover separate each compartment to retain food temperature and reduce spills.



Tray on Tray

Use Insert Tray and Base Tray to serve hot and cold foods together.



Meal Delivery

Deep compartments and snap-on cover.

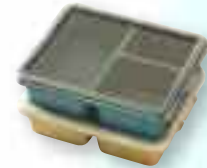

HEALTHCARE

Dietary Trays

Low profile offers patient comfort. Made of durable fiberglass.

Camtray and Century Camtray also recommended for patient meal delivery.





CENTURY CAMTRAY®

- Sleek, contemporary design.
- Features low edges and ergonomic corners that enhance customer comfort while dining.
- Increased space utilization.
- Durable fiberglass construction.
- Stacking capacity is 30% greater than Camtrays.
- Stacking lugs allow free air circulation for fast drying and perfect stacking.

Century Tray is Covered by U.S. Patent D550,043 S.

Personalization available in digital process only.

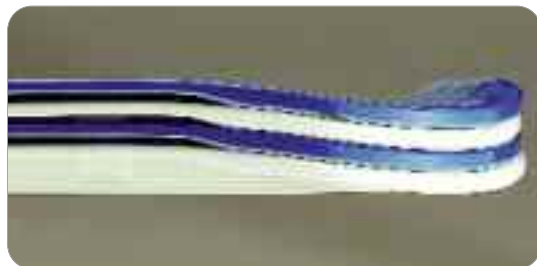

Stacking lugs allow air circulation for fast drying and perfect stacking.



Low profile design increases space utilization of tray surface.

Available colors:



Black (110)

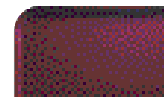

Burgundy Wine (522)



Cherry Red (505)



Antique Parchment (101)



Desert Tan (104)

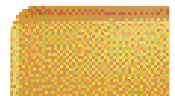

Tuscan Gold (171)

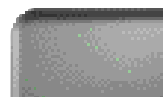

Pearl Gray (107)

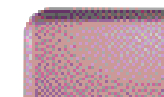

Blush (409)

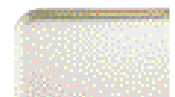

Cottage White (538)

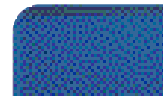

Amazon Blue (123)

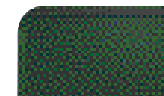

Sherwood Green (119)

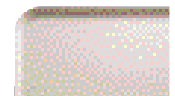

Light Peach (106)



White (148)



Horizon Blue (105)



Pacific Blue (610)

CODE	DIMENSIONS	CASE LBS. (CUBE)	LIST PRICE EA.
1418C	14" x 18"	17.5 (0.53)	\$ 19.15
1520C	15" x 20"	24.25 (0.62)	23.15

Case Pack: 12 InStock Colors: Antique Parchment (101), Black (110).



Class of 1966

Nothing withstands the test of time like a Cambro® Camtray.® Designed to outlast just about everything and everyone, Camtrays are guaranteed against cracking, warping or breakage for five years. Durable fiberglass construction ensures that Camtrays will perform in the most demanding environments and last for decades. Available in the widest selection of sizes, shapes and colors. Camtrays can be personalized with digital quality images featuring your logo or design.



Eight stacking lugs ensure straight stacking. Dri-Stak separators allow for quick drying.



Permanent decorations. All patterns and decorations are molded under tough surface mat and resin to last.



Top fiberglass layer is smooth and strong. Coupled with polyester resin, it resists impact, stains and chemicals.

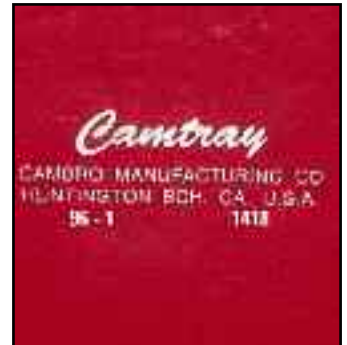

Each tray is dated on the bottom (production year and quarter), demonstrating how long it lasts.

CAMTRAY®

- Use in restaurants, hotel room service, cafeterias, food courts, hospitals and schools.
- Durable construction backed by five year guarantee against breakage.
- Made of lightweight, high-impact fiberglass with reinforced edges.
- Stain, odor and scratch resistant.
- Molded-in Dri-Stak separators ensure even air flow between trays for quick drying.
- Stacking lugs keep trays stacked in place.



Rectangular Camtrays

The industry standard.

Available in Group I colors and patterns and Group III Wood.



Trapezoid Camtrays

Saves tabletop space and increases seating capacity.

Available in Group I colors and patterns and Group III Wood.

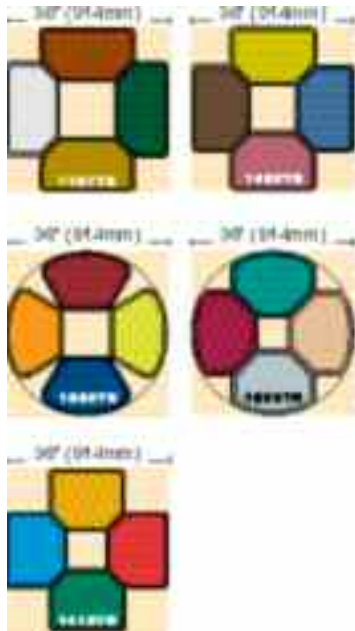

CODE	DIMENSIONS	CASE PACK	CASE LBS. (CUBE)	LIST PRICE EA.	
				GROUP I	GROUP III
Rectangular					
46	4¼" x 6"	12	1.86 (0.07)	\$ 4.40	\$ 6.15
57*	4½" x 6½"	12	1.97 (0.07)	4.75	6.70
810	8" x 9⅞"	12	6.46 (0.22)	10.50	13.60
915	8¾" x 15"	12	10.16 (0.39)	14.95	17.30
926*	8⅞" x 25⅞" x 1"	12	17.74 (0.76)	19.55	25.25
1014	10⅞" x 13¾"	12	10.43 (0.42)	13.85	17.90
1216	12" x 16⅝"	12	13.01 (0.59)	16.00	21.00
1318*	12⅝" x 17¾" x 1⅞"	12	17.48 (0.75)	19.85	24.80
1418	14" x 18"	12	19.52 (0.75)	19.15	24.95
1520	15" x 20¼"	12	21.22 (0.80)	23.15	30.00
1622	16" x 22"	12	28.54 (1.02)	26.65	34.65
16225*	16½" x 22½"	12	30.40 (1.09)	29.20	36.45
1826	17⅞" x 25¾"	6	16.7 (1.91)	35.50	45.70
2025*	20¼" x 25⅞"	6	21.39 (0.71)	43.25	52.70
Trapezoid					
1121TR*	11" x 21"	12	15.74 (0.65)	18.60	24.35
1320TR*	13" x 19½"	12	14.46 (0.70)	20.50	26.95
1418TR	14" x 18"	12	14.41 (0.63)	18.15	24.50
1422TR*	14" x 22"	12	17.14 (0.84)	19.85	26.85
1520TR*	14⅞" x 19½"	12	16.4 (0.66)	21.20	27.70

InStock Colors: Antique Parchment (101), Black (110). * Special order item not carried in stock, non-returnable. One case order minimum.

CAMTRAY®

Oval Camtrays

Perfect for banquet service.

Available in Group I colors and patterns except Doily and Group III patterns.

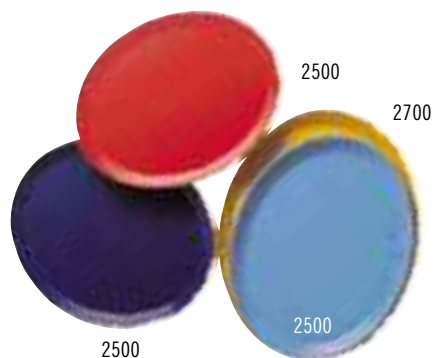

Round Camtrays

A favorite for pizza and beverage service.

Available in Group I colors and patterns except Doily and Group III patterns.

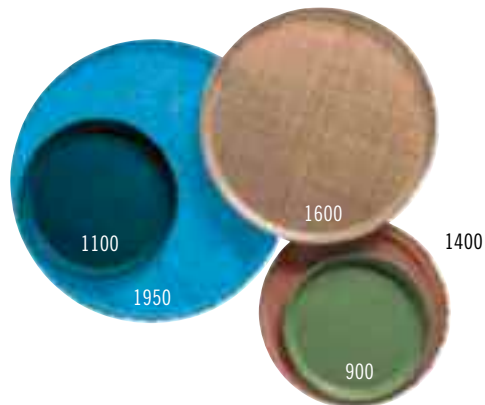

Insert Camtrays

Fits onto a Camtray to separate hot and cold food, ideal for dietary tray service.

Available in Group I colors and patterns except Doily.



CODE	DIMENSIONS	CASE PACK	CASE LBS. (CUBE)	LIST PRICE EA.	
				GROUP I	GROUP III
Oval					
2500*	19¼" x 24"	6	15.67 (0.87)	\$ 34.60	\$ 45.70
2700*	22" x 26½"	6	18.75 (0.72)	40.30	53.35
Round					
900*	9"	12	4.43 (0.21)	10.65	13.50
1000*	10"	12	6.19 (0.26)	11.75	15.25
1100	11"	12	7.25 (0.34)	11.75	14.90
1200*	12"	12	8.24 (0.33)	13.00	17.40
1300*	13"	12	9.42 (0.44)	14.30	18.90
1400	14"	12	13.94 (0.51)	14.60	19.75
1550*	16" <i>low profile</i>	12	16.36 (0.70)	18.65	24.30
1600	16"	12	15.40 (0.73)	18.30	24.50
1950*	19½" <i>low profile</i>	12	25.26 (1.04)	25.25	33.30
Insert					
1015* (2 trays fit into a 1520)	10¾" x 15"	24	22.89 (0.85)	14.30	18.55
1116* (2 trays fit into a 1622)	10¾" x 15½"	24	24.50 (1.07)	15.00	21.00

* Special order item not carried in stock non-returnable. One case order minimum.

DIETARY TRAYS, METRIC CAMTRAYS® & V-SERIES TRAYS

Dietary Trays

- Designed specifically for in-room patient feeding.
- Low slope edge provides easy access when dining from a hospital bed.
- Made of lightweight fiberglass with reinforced edges.

Available in Group I colors and patterns and Group III Wood.

Dietary trays are guaranteed for one year against breakage.



CODE	DIMENSIONS	CASE PACK	CASE LBS. (CUBE)	LIST PRICE EA.	
				GROUP I	GROUP III
Dietary					
1216D*	12" x 16"	12	14.02 (0.47)	\$16.55	\$ 21.95
1219D*	12" x 19"	12	17.42 (0.64)	19.45	25.10
1220D*	12" x 20"	12	16.45 (0.65)	21.05	27.00
1222D*	12" x 22"	12	20 (0.71)	21.05	26.95
1418D*	14" x 18"	12	16.56 (0.65)	19.25	25.45
1520D*	15" x 20 ³ / ₁₆ "	12	10.76 (0.78)	22.90	28.95
1622D*	15 ⁷ / ₈ " x 21 ⁷ / ₈ "	12	26 (1.02)	26.25	34.30



* Special order item not carried in stock, non-returnable. One case order minimum.

Metric Camtrays

Designed to meet international specifications.

Available in Group I colors and patterns and Group III Wood. 3555TR is available in Group I colors and patterns except Doily.



CODE	DIMENSIONS	CASE PACK	CASE LBS. (CUBE)	LIST PRICE EA.	
				GROUP I	GROUP III
Metric					
1313*	13" x 13" (33 x 33 cm)	12	13.8 (0.43)	\$ 14.30	\$ 18.75
2632*	10 ¹ / ₁₆ " x 12 ³ / ₄ " (26,5 x 32,5 cm)	12	10 (0.35)	13.55	17.50
3046*	11 ¹³ / ₁₆ " x 18 ³ / ₈ " (30 x 46 cm)	12	17.5 (0.57)	17.00	22.55
3242*	12 ¹ / ₂ " x 16 ¹ / ₂ " (31,9 x 41,9 cm)	12	7.2 (0.50)	16.40	18.90
3253*	12 ³ / ₄ " x 20 ³ / ₈ " (32,5 x 53 cm)	12	17.04 (0.66)	20.20	27.00
3343*	13" x 17" (33 x 43 cm)	12	15.51 (0.50)	17.05	22.70
3753*	14 ¹ / ₁₆ " x 20 ³ / ₈ " (37 x 53 cm)	12	22.96 (0.86)	23.00	30.05
3853*	14 ³ / ₄ " x 20 ³ / ₈ " (37,5 x 53 cm)	12	22 (0.81)	22.80	30.05



* Special order item not carried in stock, non-returnable. One case order minimum.

V-Series Trays

- An all-purpose back of the house kitchen tray.
- Ideal for pre-portioning ingredients.

- Made of non-porous material that resists stains and odors.
- Microwave safe and oven safe up to 350°F (130°C).

Color: Antique Parchment (101).



CODE	DIMENSIONS	CASE PACK	CASE LBS. (CUBE)	LIST PRICE EA.	
				GROUP I	GROUP III
1000VT	10"	12	7.65 (0.25)	10.60	—



CAMTRAY® GROUP I PATTERNS

Galaxy



Antique Parchment
(526 Gold), (531 Silver)

Swirl



Black & Gold (270)

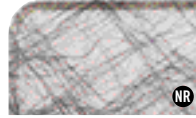

Gray (277)

Doily



Antique Parchment (241)



Light Peach (246)



Grass Mat (203)

Abstract



Tan (214)



Gray (215)

Linen



Toffee (329)



NR Trays are non-returnable.

CAMTRAY GROUP III WOOD

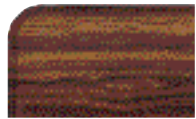

Burma Teak (308)



Country Oak (304)



Dark Basketweave (301)



Java Teak (309)



Light Basketweave (302)



Light Butcher Block (303)

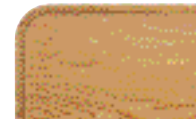

Light Elm (307)



Rattan (204)

CAMTRAY GROUP I COLORS – Numerical Reference by Color Code

Antique Parchment (101),
Desert Tan (104), Horizon Blue (105),
Light Peach (106), Pearl Gray (107),
Black (110), Lime-ade (113),
Brazil Brown (116), Dark Peach (117),
Sherwood Green (119),

Amazon Blue (123), White (148),
Tuscan Gold (171), Sky Blue (177),
Taupe (199), Citrus Orange (220),
Ever Red (221), Orange Pizzazz (222),
Slate Blue (401), Blush (409),
Raspberry Cream (410), Teal (414),

Olive Green (428), Key Lime (429),
Real Rust (501), Mustard (504),
Cherry Red (505), Suede Brown (508),
Signal Red (510), Bayleaf Brown (513),
Earthen Gold (514), Robin Egg Blue (518),
Cambro Red (521), Burgundy Wine (522),

Lemon Chiffon (536), Cameo Yellow (537),
Cottage White (538), Grape (551).

**Due to the catalog printing process, the colors & patterns shown may not be exact.
Contact Cambro or a Cambro representative for a color chip.**

CAMTRAY® GROUP I COLORS

Due to the catalog printing process, the colors shown may not be exact. For exact colors, contact Cambro or a Cambro representative for a color chip.

Colors listed alphabetically. See numerical reference on following page.

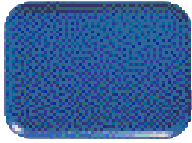

Amazon Blue (123)

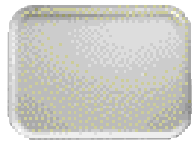

Antique Parchment (101)

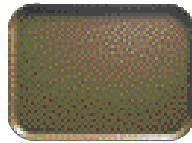

Bay Leaf Brown (513)

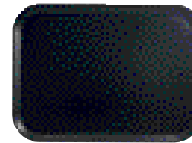

Black (110)

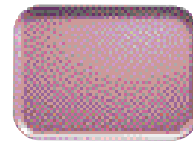

Blush (409)

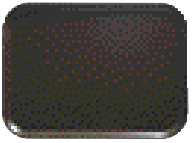

Brazil Brown (116)

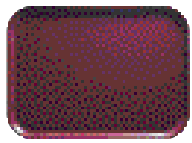

Burgundy Wine (522)

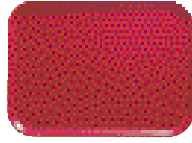

Cambro Red (521)



Cameo Yellow (537)



Cherry Red (505)

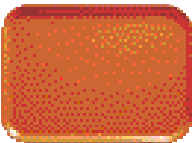

Citrus Orange (220)



Cottage White (538)

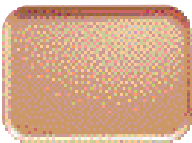

Dark Peach (117)



Desert Tan (104)

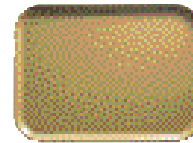

Earthen Gold (514)

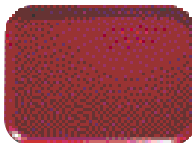

Ever Red (221)

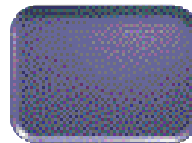

Grape (551)

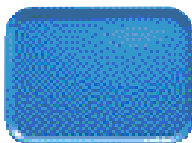

Horizon Blue (105)

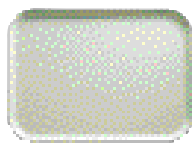

Key Lime (429)

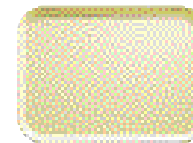

Lemon Chiffon (536)

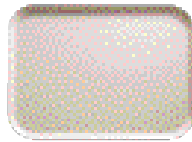

Light Peach (106)

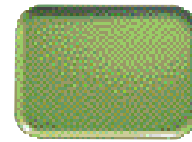

Lime-ade (113)

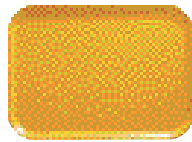

Mustard (504)

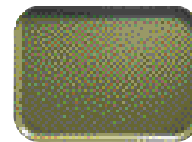

Olive Green (428)

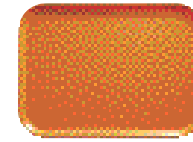

Orange Pizzazz (222)



Pearl Gray (107)

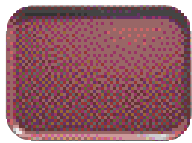

Raspberry Cream (410)

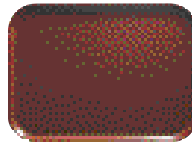

Real Rust (501)

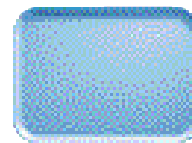

Robin Egg Blue (518)

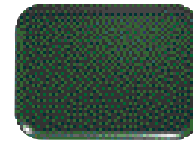

Sherwood Green (119)

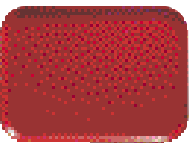

Signal Red (510)

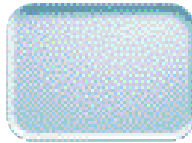

Sky Blue (177)

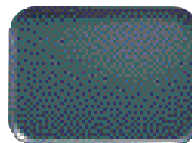

Slate Blue (401)

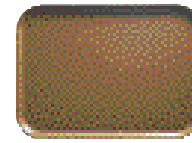

Suede Brown (508)

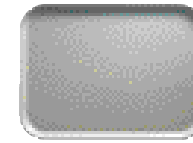

Taupe (199)

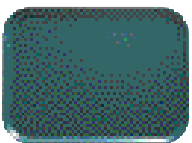

Teal (414)

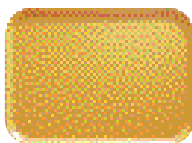

Tuscan Gold (171)

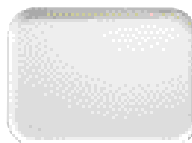

White (148)

1.800.833.3003

17

www.cambro.com

CUSTOM COLOR MATCHING

Cambro offers custom color matching on Camtrays only (minimum order quantity of 144 each per size). Upon receipt of a firm purchase order, we will request a swatch of the color you want and our expert mixologists will match it. A finished tray sample will be submitted for the customer's approval. Requests for more than one sample and samples not accompanied by a firm purchase order will be charged at \$50.00 NET. Custom color trays are non-returnable.

LET'S GET PERSONAL – PERSONALIZED CAMTRAYS®

Personalize Camtrays to display a message with every tray served. Advertise a product, promote your business, enhance patient satisfaction or strengthen school spirit.



Look for this icon that identifies items that can be personalized.



DIGITAL



DIGITAL



SILKSCREEN

PERSONALIZATION CHARGES (NET)

Tray Sample

\$50.00 (Charge will be billed on sample order, credited on first purchase order)

TRAY QUANTITY	COST PER TRAY IMPRINT US DOLLAR
72 - 144	\$0.75
145 - 288	0.50
289 - 432	0.25
433 +	No Charge

Note: 72 tray order minimum is only available for trays ordered with the Digital Process. All personalized Camtray orders are full case quantities only, no partial case orders accepted.

DIGITAL

Print Area on Tray:

1" from inside edge of tray

Sample Turnaround:

5-7 Business Days

Tray Order Minimum: 72

SILKSCREEN

Print Area on Tray:

Entire tray surface to outer rim

Sample Turnaround:

7-10 Business Days

Tray Order Minimum: 144

HOW TO ORDER A SAMPLE

1. Request a Sample

Contact your local Cambro representative to complete and submit the sample request form to Cambro.

2. Provide Artwork

Provide ready to use artwork, digital format only. Sample request form must be submitted to Cambro PRIOR to artwork being sent. If artwork is incomplete, graphic support services are available for \$50.00 per hour.

3. Submit Artwork

E-mail artwork to Cambro Rep or to Cambro at letsgetpersonal@Cambro.com. Title e-mail subject with logo name and provide contact info.

File dimensions: 100% reproduction size, 300 dpi resolution.

File type: Adobe® Illustrator®, Photoshop®, or QuarkXpress®.

File format: jpeg, tiff, and eps.

Or mail artwork on a CD-ROM to: Cambro Attn: Kristie Patterson, 7601 Clay Avenue, Huntington Beach, CA 92648.

4. Questions

Contact Kristie Patterson at 714-230-4125 direct or 800-854-7631 ext. 4125.

5. Sample Approval

A signed sample approval form must be faxed to Cambro customer service prior to processing any purchase orders. This form is included with each sample.

CAMWEAR® POLYCARBONATE & CAMLITE® TRAYS

Camwear Trays

- Ideal for use in correctional facilities.
- Made from virtually unbreakable polycarbonate.
- Large stacking lugs keep trays straight and in place when stacked.
- Molded-in Dri-Stak separators allow air flow between trays for quick drying.

Colors: Blue (168), Beige (133), White (148).



CODE	DIMENSIONS	CASE PACK	CASE LBS. (CUBE)	LIST PRICE EA.
Rectangular				
1216CW	11 ⁷ / ₈ " x 16 ¹ / ₄ "	12	14.58 (0.55)	\$ 16.65
1418CW	13 ¹⁵ / ₁₆ " x 17 ¹⁵ / ₁₆ "	12	17.43 (0.67)	23.10
1520CW	14 ⁷ / ₈ " x 20 ⁷ / ₈ "	12	20.50 (0.87)	24.05
Trapezoid				
1418TRCW	14" x 18"	12	16 (0.72)	23.10

Camlite Trays

- An economical, all-purpose tray for self-serve food service dining.
- Made of fiberglass with reinforced corners.
- Stacking lugs keep trays straight.
- Molded-in Dri-Stak separators allow air circulation for quick drying.
- Camlite Trays cannot be personalized.

Colors: Rose Red (163), Yellow (145), Green (162), Blue (142), Tan (161), Steel White (676), Steel Red (675), Steel Blue (674).

12 dozen minimum order required for any special color orders.



CODE	DIMENSIONS	CASE PACK	CASE LBS. (CUBE)	LIST PRICE EA.
Rectangular				
1014CL	10 ⁵ / ₈ " x 13 ³ / ₄ "	12	11.15 (0.40)	\$12.60
1216CL	12" x 16 ⁵ / ₁₆ "	12	12.92 (0.57)	14.25
1418CL	14" x 18"	12	17.59 (0.67)	15.55
1520CL	15" x 20 ¹ / ₄ "	12	22.06 (0.82)	17.75
1826CL	17 ⁷ / ₈ " x 25 ³ / ₄ "	12	32.06 (1.34)	25.55
3253CL	12 ³ / ₄ " x 20 ⁷ / ₈ "	12	18.87 (0.67)	15.30
3753CL	14 ⁷ / ₁₆ " x 20 ⁷ / ₈ "	12	22.25 (0.80)	17.25

MARKET TRAYS & PANS

- Attractively merchandise desserts, pastries, hors d'oeuvres and salads.
- Ideal for use in bakeries, supermarkets and delis.
- High-impact resistant fiberglass with reinforced edges provide strength.
- Trays and pans resist odors and will not oxidize like aluminum trays.
- Pans feature a 2" (5 cm) rim for salads and ready to eat foods.

Colors: Salmon (149), Yellow (145), Blue (142), Green (140), White (148).
Colors NSF listed for food contact: White (148), Blue (142), Green (140), Black (110).



Market Trays make appealing bakery merchandising quick and easy.



Market Pans showcase deli items.

CODE	DIMENSIONS W x L x H	CASE PACK	CASE LBS. (CUBE)	LIST PRICE EA.
Market Trays				
630MT*	6 ⁷ / ₁₆ " x 30" x 3 ³ / ₄ "	12	14.54 (0.57)	\$ 17.80
826MT*	8 ³ / ₄ " x 25 ¹ / ₂ " x 3 ³ / ₄ "	12	16.48 (0.52)	14.60
830MT*	8 ⁷ / ₁₆ " x 30" x 3 ³ / ₄ "	12	20.50 (0.75)	20.15
918MT*	8 ¹¹ / ₁₆ " x 18" x 1 ¹³ / ₁₆ "	12	10.22 (0.40)	16.90
926MT*	8 ⁷ / ₈ " x 25 ⁵ / ₁₆ " x 1"	12	16.42 (0.79)	18.80
1015MT*	10 ¹ / ₈ " x 15" x 3 ³ / ₄ "	24	13.75 (0.85)	14.10
1030MT*	10 ⁷ / ₁₆ " x 30" x 3 ³ / ₄ "	12	22.50 (0.83)	22.25
1218MT*	11 ¹ / ₂ " x 17 ³ / ₄ " x 1"	12	15.50 (0.63)	17.60
1224MT*	12 ¹ / ₁₆ " x 24" x 3 ³ / ₄ "	12	21.38 (0.82)	22.05
1227MT*	12 ¹ / ₁₆ " x 27" x 3 ³ / ₄ "	12	25.57 (0.88)	23.75
1230MT*	12 ¹ / ₁₆ " x 30" x 3 ³ / ₄ "	12	25.13 (0.96)	25.60
1318MT*	12 ⁵ / ₈ " x 17 ³ / ₄ " x 1 ¹ / ₁₆ "	12	17.56 (0.76)	18.05
1826MT*	17 ¹³ / ₁₆ " x 25 ¹¹ / ₁₆ " x 1 ¹ / ₁₆ "	6	16.58 (0.88)	28.75
2025MT*	20 ³ / ₄ " x 25 ⁹ / ₁₆ " x 1 ³ / ₁₆ "	6	21 (0.80)	37.70

* Special order item not carried in stock, non-returnable. One case order minimum.

CODE	DIMENSIONS W x L x H	CASE LBS. (CUBE)	LIST PRICE EA.
Market Pans			
6302MT*	6 ⁷ / ₁₆ " x 30" x 2"	17.52 (0.72)	\$ 27.95
8262MT*	8 ³ / ₈ " x 25 ¹ / ₂ " x 2"	21 (0.93)	22.90
8302MT*	8 ⁷ / ₁₆ " x 30" x 2"	23.69 (0.90)	30.75
92615MT*	8 ⁷ / ₈ " x 25 ¹ / ₂ " x 1 ¹ / ₂ "	19.65 (0.72)	18.75
10302MT*	10 ¹ / ₁₆ " x 30" x 2"	28 (1.15)	32.90

Case Pack: 12

* Special order item not carried in stock, non-returnable. One case order minimum.

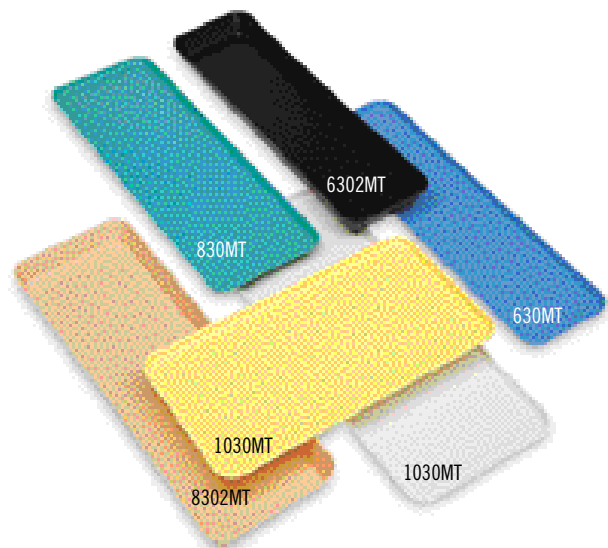

FAST FOOD TRAYS

- Perfect for self-serve or quick-serve dining.
- Made of durable polypropylene.
- Attractive textured surface hides scratches.



CODE	DIMENSIONS	CASE PACK	CASE LBS. (CUBE)	LIST PRICE EA.
1014FF	10 ⁷ / ₁₆ " x 13 ³ / ₁₆ "	24	13.02 (0.61)	\$ 3.70
1216FF	11 ⁷ / ₈ " x 16 ⁷ / ₈ "	24	18.84 (1.01)	4.45
1418FF	13 ³ / ₁₆ " x 17 ³ / ₄ "	12	13.50 (0.63)	5.65

InStock Colors: Black (110), Red (163).

LET'S GET PERSONAL — FAST FOOD TRAYS

Personalized Fast Food Trays display a message with every tray served. Advertise products, promote your business and brand or strengthen school spirit.

Available Colors:

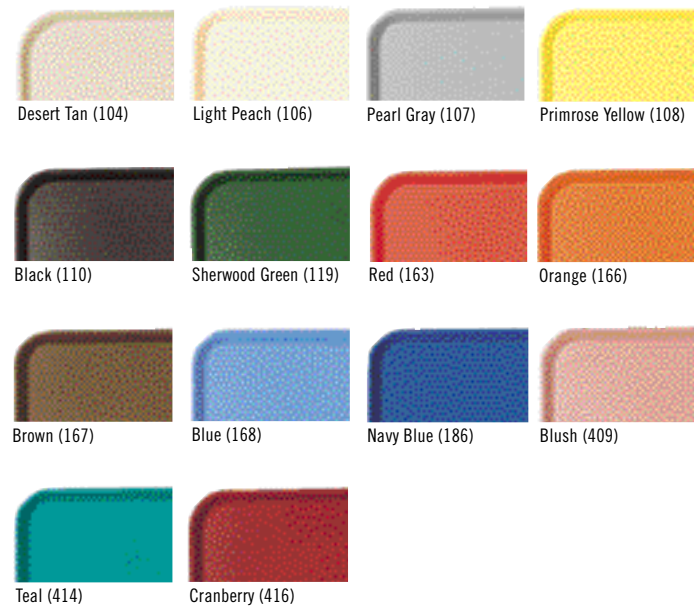

HOW TO ORDER A SAMPLE

1. Request a Sample

Contact your local Cambro rep to complete and submit the sample request form to Cambro. Specify location of imprint on tray. Maximum imprint size: 6" x 6".

2. Provide Artwork

Provide ready to use artwork, digital format only. Sample request form must be submitted to Cambro **PRIOR** to artwork being sent. If artwork is incomplete, graphic support services will be offered for \$50.00 per hour.

3. Submit Artwork

E-mail artwork to your Cambro Rep or the Cambro Personalization Dept. at letsgetpersonal@Cambro.com. Title e-mail subject with logo name and provide contact info. **File dimensions:** 100% reproduction size, 300dpi resolution. **File type:** Adobe® Illustrator®, Photoshop®, or QuarkXpress®. **File format:** jpeg, tiff, and eps. Or mail artwork on a CD-ROM to: Cambro Manufacturing Company Attn: Kristie Patterson, Cambro, Personalization Dept., 7601 Clay Avenue, Huntington Beach, CA 92648.

4. Questions

Call Kristie Patterson at 714-230-4125 direct or 800-854-7631 ext. 4125.

5. Sample Approval

Signed approval form must be faxed to Cambro customer service prior to processing any purchase orders. Approval form included with each sample tray.

PERSONALIZATION CHARGES (NET)

Tray Sample

\$50.00 (Charge will be billed on sample order, credited on first purchase order)

Custom Die Charge

\$75.00 (Billed on sample order, one time charge)

TRAY QUANTITY	COST PER TRAY
288-767	\$ 0.36
768-1199	0.27
1200-5999	0.18
6000-11,999	0.14
12,000 +	0.12

CAMTREAD® TRAYS

- An industry standard for caterers, hotels, banquet halls, dining rooms and bars.
- Non-skid surface ensures drinks and meals stay in place during transport.
- Made of heavy-duty, durable fiberglass with a thick molded in, non-skid surface.

1800CT in Black and Tavern Tan only.

Orders for non-standard Camtread Tray colors will be handled by special quotation only.

* Special order item not carried in stock, non-returnable. One case order minimum.

Do not use Camtread Trays in enclosed heated carts.



1400CT Non-skid, non-slip trays. Less breakage, greater profits.

Tray Colors:



22

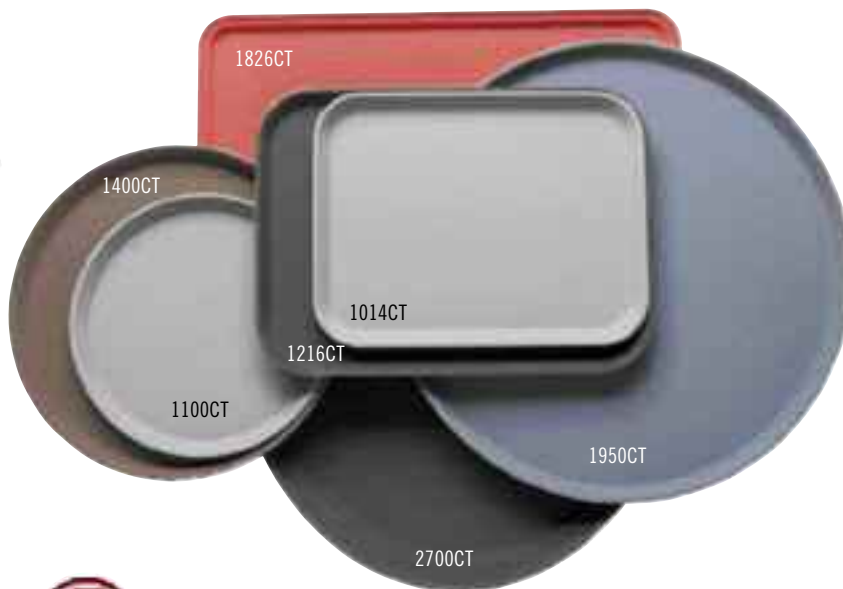

FIVE YEAR GUARANTEE AGAINST DELAMINATION



CODE	DIMENSIONS	CASE PACK	CASE LBS. (CUBE)	LIST PRICE EA.
Round				
900CT*	9"	12	5.79 (0.22)	\$ 17.30
1100CT	11"	12	8.95 (0.32)	17.30
1400CT	14"	12	14 (0.52)	23.00
1550CT*	16" <i>low profile</i>	12	18.48 (0.70)	31.25
1600CT	16"	12	25.75 (0.68)	30.30
1800CT	18"	6	12.6 (0.52)	43.00
1950CT*	19 ¹ / ₁₆ " <i>low profile</i>	12	30.15 (1.05)	44.00
Oval				
2500CT	19 ¹ / ₄ " x 23 ³ / ₁₆ "	6	18.76 (0.84)	54.75
2700CT	22" x 26 ¹ / ₁₆ "	6	24.50 (1.33)	61.60
2900CT	28 ³ / ₈ " x 23 ¹ / ₂ "	6	28.57 (0.91)	69.90
Rectangular				
1014CT*	10 ³ / ₁₆ " x 13 ³ / ₄ "	12	13.76 (0.42)	21.30
1216CT*	12" x 16 ¹ / ₁₆ "	12	17.78 (0.59)	24.60
1418CT	14" x 18"	12	22.01 (0.68)	30.65
1520CT*	15" x 20 ¹ / ₄ "	12	19.48 (0.7)	34.85
1622CT*	16" x 22"	12	39.46 (1.01)	43.00
1826CT	17 ¹ / ₁₆ " x 25 ¹ / ₁₆ "	6	23.33 (0.91)	51.60
3253CT*	12 ³ / ₄ " x 20 ³ / ₁₆ "	12	27.10 (0.75)	35.85

InStock Colors: Black Satin (110), Tavern Tan (138).

CAMTREAD® TRAYS DESIGNER SERIES

- Wood design provides an elegant look for upscale restaurants, bars, and luxury hotels.
- Non-skid surface ensures drinks and meals stay in place during transport.
- Durable fiberglass construction with molded-in, non-stick surface handles heavy weight loads.
- Stacking lugs promote air circulation and perfect stacking.



Black on Venge (384)



Tavern Tan on Walnut (376)



Tavern Tan on Teak (377)



CODE	DIMENSIONS	CASE LBS. (CUBE)	LIST PRICE EA.
1400CT	14"	14.28 (0.58)	\$26.25
1600CT	16"	21.12 (0.75)	34.60

Case Pack: 12 InStock Colors: Black on Venge (384), Tavern Tan on Walnut (376), Tavern Tan on Teak (377).

NON-SLIP POLYTREAD® TRAYS

- An economical service tray for restaurants, bars and banquet service.
- General, all-purpose, non-skid service trays help reduce spills and breakage.
- Special non-skid surface is bonded directly into a lightweight polypropylene tray.
- Dri-Stak separators allow air to circulate freely over and under each tray for fast drying.



Tray Colors:



Black (110)

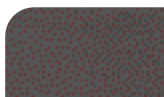

Brown (167)

CODE	DIMENSIONS	CASE PACK	CASE LBS. (CUBE)	LIST PRICE EA.
Round				
PT1100	11"	12	6.75 (0.31)	\$ 9.35
PT1400	14"	12	10.44 (0.53)	12.50
PT1600	16"	12	12.88 (0.66)	16.85
Rectangular				
PT1014	10 ⁹ / ₁₆ " x 13 ⁵ / ₈ "	24	19.50 (0.76)	11.95
PT1216	11 ⁷ / ₈ " x 16 ¹ / ₄ "	24	25.25 (1.11)	13.05
PT1418	14" x 18"	12	18.25 (0.81)	16.55



SCHOOL COMPARTMENT TRAYS

- Perfect for school lunch programs.
- Easy to hold trays have five food compartments and one compartment for silverware.
- Textured surface resists scratching.
- Camwear is made with virtually unbreakable polycarbonate. Budget is made with ABS. Penny-Saver is made with economical co-polymer. All are FDA approved for food contact.



CODE	DIMENSIONS W x L x D	CASE PACK	CASE LBS. (CUBE)	LIST PRICE EA.
Camwear®				
10146CW	10" x 14½" x ¾"	24	20.59 (1.05)	\$ 12.70
Budget				
BCT1014	10" x 14½" x ¾"	24	18.11 (0.98)	9.30
Penny-Saver				
PS1014	10" x 14½" x ¾"	24	13.73 (0.83)	5.80

Co-Polymer trays are not NSF listed.

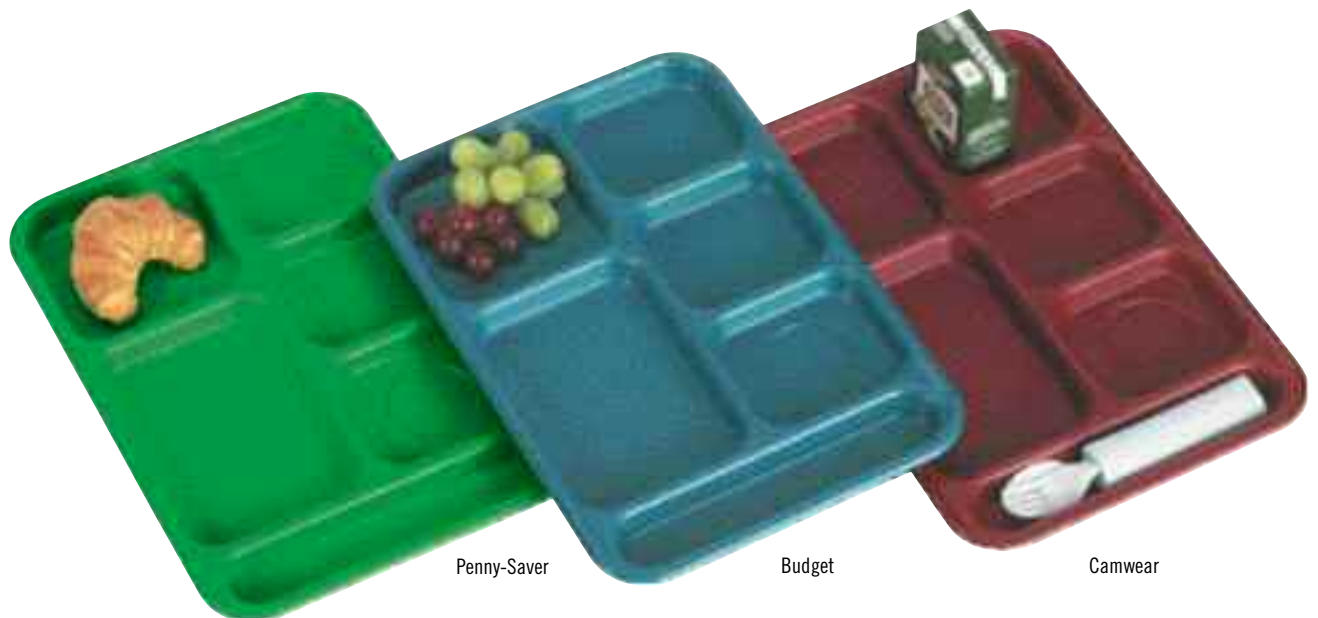

Budget Colors



Camwear Colors



Penny-Saver Colors



2 X 2 COMPARTMENT TRAYS

- Ideal for use in schools and day care facilities.
- Fit 18 each, side-by-side (or 2 x 2) in a standard full size peg rack.
- Gradual sloping compartment walls promote quick draining and faster drying.
- “Easy grip” handles ensure a better grip for children with smaller hands.

Co-Polymer trays are not NSF listed.

1596CW and 1596CP are covered by U.S. Patent D 355,333.

915CW, 100CW, SRB13CW and 50CW bowls fit in round compartment. 10CW and 150CW bowls fit in square compartment. See Dinnerware and Swirl Bowl® sections.



Camwear compartment trays are guaranteed for two years against breakage.

Camwear®



Sherwood Green (119)



Red (404)



Beige (133)



Teal (414)



Blue (168)



Cranberry (416)



Navy Blue (186)

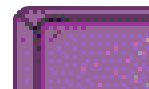

Translucent Purple (430)



Translucent Blue (431)

Co-Polymer



Grass Green (437)

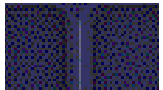

Navy Blue (186)

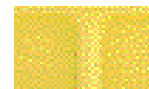

Yellow (145)

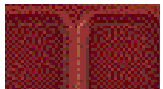

Cranberry (416)



1596CW & 1596CP



915CW & 915CP

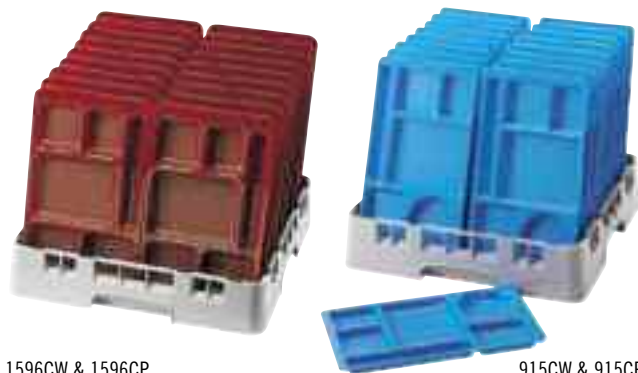

1596CW & 1596CP

915CW & 915CP

CODE	DIMENSIONS W x L x D	CASE LBS. (CUBE)	LIST PRICE EACH
Camwear			
1596CW	9" x 15" x 7/8"	20.64 (0.56)	\$ 11.15
915CW	8 3/4" x 15" x 3/4"	17.34 (0.94)	11.15
Co-Polymer			
1596CP	9" x 15" x 7/8"	20 (0.60)	6.15
915CP	8 3/4" x 15" x 3/4"	10.14 (0.92)	6.15

Case Pack: 24

COMPARTMENT SERVING TRAYS & TRAPEZOID COMPARTMENT TRAYS

Compartment Serving Trays

- For cafeteria-style feeding in high security environments.
- Compartment configurations designed to meet all menu requirements.

Camwear® Polycarbonate

6-Compartment

Colors: Navy (186), Cranberry (416), Yellow (145), Sherwood Green (119), Beige (133).

5-Compartment

Colors: Beige (133).

Co-Polymer

Colors: Teal (414), Brown (167), Tan (161).



Co-Polymer is not NSF Listed.



14105CW tray with 10CW bowl and 10CWL lid

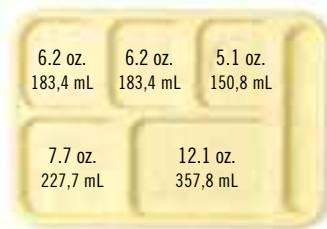

10146CW

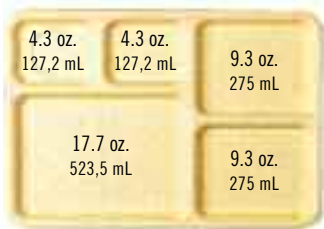

10145CW



14105CW

Also Available in 14105CP



Trapezoid Compartment Trays

- Space saving tray for self serve correctional facility feeding.
- Offers seven deep compartments for ample, portion controlled servings.
- Serve soup and salad at the same time.

Camwear Colors: Beige (133).

Co-Polymer

Colors: Tan (161), Brown (167).

Trapezoid Compartment Trays are covered by the following U.S. Patent D 508,634.

Co-Polymer is not NSF Listed.



14187TRCW

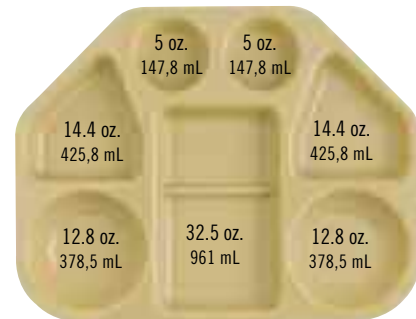

CODE	DESCRIPTION	DIMENSIONS W x L x D	CASE LBS. (CUBE)	LIST PRICE EA.
Camwear Polycarbonate				
10146CW	6 Compartments	10" x 14½" x 1½"	20.59 (1.05)	\$ 12.70
14105CW	5 Compartments	10⅓" x 13⅞" x 1⅞"	19.8 (0.65)	13.90
10145CW	5 Compartments	10" x 14½" x 1½"	20.75(0.99)	13.85
Co-Polymer				
14105CP	5 Compartments	10⅓" x 13⅞" x 1⅞"	15.01 (0.67)	6.25

Case Pack: 24

CODE	DESCRIPTION	DIMENSIONS W x L x D	CASE LBS. (CUBE)	LIST PRICE EA.
7 Compartment Trapezoid Tray				
14187TRCW	Camwear	14" x 17⅓" x 1½"	22.36 (1.34)	\$ 24.90
14187TRCP	Co-Polymer	17¼" x 13⅓" x 1½"	17.01 (1.34)	15.10

Case Pack: 12

MEAL DELIVERY TRAYS & SEPARATOR® COMPARTMENT TRAYS

Meal Delivery Trays

- Three deep-dish food compartments for large portions.
- Snap-on cover fits securely.
- Textured surface minimizes scratching.

Camwear® Polycarbonate

Colors: Beige (133), Teal (414).
Lid Color: Clear (135).

Co-Polymer

Colors: Teal (414), Brown (167), Tan (161).
Lid Color: White (148).



Co-Polymer is not NSF Listed.

Separator Compartment Trays

- Six compartment tray designed specifically for in-cell feeding programs.
- Serve both hot and cold food from the same tray.
- Tray with cover separates each compartment to retain food temperature and reduce spills.
- Locking ridges on top of cover and bottom of tray ensure more secure stacking.

Camwear Polycarbonate

Color: Beige (133).
Lid Color: Clear (135).

Co-Polymer

Colors: Teal (414), Brown (167), Tan (161).
Lid Color: Translucent (190).



Co-Polymer is not NSF Listed.



CODE	DESCRIPTION	DIMENSIONS W x L x D	CASE LBS. (CUBE)	LIST PRICE EA.
Camwear Polycarbonate				
9113CW	3 Compartments	9" x 11" x 2 ⁵ / ₁₆ "	24 (1.66)	\$ 14.85
9114CW	4 Compartments	9" x 11" x 2 ¹ / ₂ "	26 (1.67)	15.50
911CWC	Lid fits both trays		12.75 (0.68)	10.50
Co-Polymer				
9113CP	3 Compartments	9" x 11" x 2 ⁵ / ₁₆ "	16.83 (1.57)	6.40
9114CP	4 Compartments	9" x 11" x 2 ¹ / ₂ "	20 (1.67)	6.40
911CPC	Lid fits both trays		9.39 (0.66)	3.50

Case Pack: 24



CODE	DESCRIPTION	DIMENSIONS W x L x D	CASE LBS. (CUBE)	LIST PRICE EA.
Camwear Polycarbonate				
10146DCW	6 Compartments	10" x 14 ³ / ₁₆ " x 1 ¹ / ₁₆ "	24.50 (1.08)	\$ 16.30
10146DCWC	Lid fits 10146DCW		9.79 (1.21)	8.65
Co-Polymer				
10146DCP	6 Compartments	9 ⁷ / ₈ " x 14" x 1 ³ / ₈ "	17.9 (1.56)	8.10
10146DCPC	Lid fits 10146DCP		14.75 (0.96)	4.75

Case Pack: 24

TRAY ON TRAY MEAL DELIVERY SYSTEM

Base Tray

- Combine pre-plated hot and cold food portions into a reusable, single service unit.
- Works as a tray or for in-cell feeding with the insert tray.
- Base tray has 5 compartments with 1 compartment for nesting the insert tray.

Camwear® Polycarbonate

Color: Beige (133).

Co-Polymer

Colors: Teal (414), Brown (167), Tan (161).



1411CW

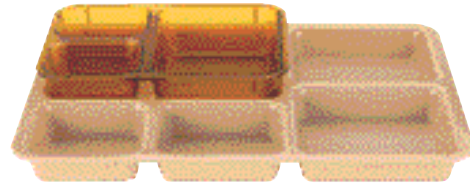

1411CW base tray with 853FH insert tray



Co-Polymer is not NSF Listed.



1411CW/1411CP

CODE	DESCRIPTION	DIMENSIONS L x W x D	CASE LBS. (CUBE)	LIST PRICE EA.
Camwear Polycarbonate				
1411CW	5 Compartments	14 ³ / ₈ " x 10 ⁵ / ₁₆ " x 1 ¹ / ₄ "	25.50 (1.25)	\$ 16.20
Co-Polymer				
1411CP	5 Compartments	14 ³ / ₈ " x 10 ⁵ / ₁₆ " x 1 ¹ / ₄ "	19.01 (1.19)	5.70

Case Pack: 24

Insert Tray

- Designed specifically for cook-chill applications as it can be covered with heat seal film or snap-on cover.
- Eight trays efficiently fit on a standard sheet pan or in an 18" x 26" (45,5 x 65,5 cm) wire rack.

Camwear Polycarbonate

Color: Beige (133).

Lid Color: Clear (135).

Co-Polymer

Colors: Teal (414), Brown (167), Tan (161).

Lid Color: Translucent (190).

Heat Resistant Plastic

Tray and Lid Color: Amber (150).



853FCW

853FCP



853FCW, 853FCWC, 853FH and 853FHC are NSF Listed. Co-Polymer is not NSF Listed.

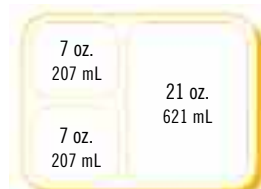

853FCW/853FCP/853FH

CODE	DESCRIPTION	DIMENSIONS L x W x D	CASE LBS. (CUBE)	LIST PRICE EA.
Camwear Polycarbonate				
853FCW	3 Compartments	8 ¹ / ₁₆ " x 6 ⁷ / ₁₆ " x 1 ¹ / ₈ "	11.47 (0.76)	\$ 10.50
853FCWC	Lid for 853FCW		6.23 (0.28)	5.55
Co-Polymer				
853FCP	3 Compartments	8 ⁹ / ₁₆ " x 6 ¹ / ₄ " x 1 ¹ / ₈ "	9.79 (0.76)	5.10
853FCPC	Lid for 853FCP		4.61 (0.28)	2.70
Heat Resistant Plastic				
853FH	3 Compartments	8 ¹ / ₁₆ " x 6 ⁷ / ₁₆ " x 1 ¹ / ₈ "	12.50 (0.77)	17.45
853FHC	Lid for 853FH		6.6 (0.46)	10.05

Case Pack: 24

TABLE SERVICE

Personalization

Dinnerware

Meal Delivery System

Camcover® Plate Covers

Pitchers

Aliso® Barware

Goblets

Tumblers

Camliters®/Decanters

6-Gallon Beverage Dispenser

Pail With Bail

Swirl Bowls

Wine Buckets

Punch Bowls

Bud Vase



LET'S GET PERSONAL

Personalize tumblers, barware, pitchers or other table service items with your logo or design. Use personalized drinkware in promotions.

Food storage products can also be personalized to identify menu items, add fill lines for recipes or to add instructions in multiple languages to help ensure product quality and consistency.



Look for this icon that identifies items that can be personalized.

IMPRINTING TABLE SERVICE AND STORAGE ITEMS

Minimum Quantity: 6 Cases

Sample Turnaround Time: 7-10 business days after receipt of approved artwork

Print Area: ¼" to 4", subject to printable area on each item

PERSONALIZATION CHARGES (NET)

Sample Charge: \$50.00 (Charge will be billed on sample order, credited on first purchase order)

Plate Charge: \$75.00 (Billed on sample order, one time charge)

Set-Up Charge: \$50.00 (Per order)

Cost Per Imprint: \$0.30 per side



CHOOSE ANY ONE OF THESE STANDARD IMPRINT COLORS



Due to the catalog printing process, the colors shown may not be exact.

HOW TO ORDER A SAMPLE

1. Request a Sample

Contact your local Cambro representative to complete and submit your sample request to Cambro.

2. Provide Artwork

Provide ready to use artwork, digital format only. Completed sample request form must be submitted to Cambro **PRIOR** to artwork being sent. If artwork is incomplete, graphic support services are available at \$50.00 per hour.

3. Submit Artwork

E-mail artwork to your Cambro Rep or direct to Cambro at letsgetpersonal@Cambro.com. Title e-mail subject with logo name and provide contact info.

File dimensions: 100% reproduction size, 300dpi resolution.

File type: Adobe® Illustrator®, Photoshop®, or QuarkXpress®.

File format: jpeg, tiff, and eps. Or mail digital artwork to: Cambro Attn: Kristie Patterson, 7601 Clay Avenue, Huntington Beach, CA 92648.

4. Questions

Call Kristie Patterson at 714-230-4125 direct or 800-854-7631 ext. 4125.

5. Sample Approval

A signed sample approval form must be faxed to Cambro customer service prior to processing any purchase orders. This form is included with each sample.

CAMWEAR® DINNERWARE

- Virtually unbreakable Camwear polycarbonate resists stains, odors and scratches.
- Textured surface on salad and dinner plates for long wear.
- Ideal for schools, cafeterias, day care centers and healthcare facilities.

Mug and stacking cup can be personalized.



5 YEAR GUARANTEE AGAINST BREAKAGE



32



Beige (133)



Black (110)



White (148)

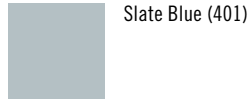

Slate Blue (401)



Oval Platters & Compartment Plates



CODE	90SPCW	120CWP	93CW	HK93BCW*
DIAMETER	9" x 1 $\frac{1}{16}$ "	12" x 9"	9"	9 $\frac{1}{2}$ "
DESCRIPTION	Round, Soup Bowl	Oval, Narrow Rim	Narrow Rim	Heat Keeper Base
CASE PACK	48	24	48	12
CASE LBS. (CUBE)	16.25 (0.66)	8.76 (0.37)	17.50 (0.75)	9.75 (0.81)
LIST PRICE EACH	\$ 6.80	\$ 7.80	\$ 6.75	\$ 14.55

*HK93BCW is available in Beige (133) only.

Plates



CODE	10CWNR	9CWNR	825CWNR	725CWNR	65CWNR	55CWNR
DIAMETER	10"	9"	8 $\frac{1}{4}$ "	7 $\frac{1}{4}$ "	6 $\frac{1}{8}$ "	5 $\frac{1}{2}$ "
DESCRIPTION	Narrow Rim	Narrow Rim	Narrow Rim	Narrow Rim	Narrow Rim	Narrow Rim
CASE PACK	48	48	48	48	48	48
CASE LBS. (CUBE)	23 (0.78)	15.88 (0.60)	15.01 (0.49)	11.23 (0.39)	9.41 (0.35)	7 (0.24)
LIST PRICE EACH	\$ 6.40	\$ 4.65	\$ 4.80	\$ 4.10	\$ 3.00	\$ 2.55

Bowls



Optional lid available

CODE	10CW	10CWL	35CW	45CW	50CW	60CW	100CW	150CW
APPROX. CAPACITY	9.4 oz.	—	8.4 oz.	5.0 oz.	15.3 oz.	10.9 oz.	12.5 oz.	16.7 oz.
DESCRIPTION	Square Bowl	Lid for 10CW Bowl	Bouillon	#3 $\frac{1}{2}$ Fruit Cup	Nappie Bowl	#1 Grapefruit Bowl	5" Nappie	Square Bowl
CASE PACK	48	48	48	48	48	48	48	48
CASE LBS. (CUBE)	6.28 (0.47)	2.66 (0.15)	5.28 (0.25)	6 (0.33)	11.66 (0.62)	11.50 (0.56)	7.50 (0.61)	7.87 (0.60)
SHAPE	Square	Square	Round	Round	Round	Round	Round	Top/Rnd-Bottom/Sqr
OUTSIDE DIA.	Top: 4" x 4"	—	3 $\frac{15}{16}$ "	4 $\frac{5}{8}$ "	5 $\frac{1}{4}$ "	6"	5"	Top: 5 $\frac{1}{4}$ "
HEIGHT	1 $\frac{7}{8}$ "	1 $\frac{5}{16}$ "	2 $\frac{7}{8}$ "	1 $\frac{1}{16}$ "	2 $\frac{7}{8}$ "	1 $\frac{1}{2}$ "	1 $\frac{1}{16}$ "	2 $\frac{3}{8}$ "
LIST PRICE EACH	\$ 3.00	\$ 2.30	\$ 2.10	\$ 2.55	\$ 3.00	\$ 3.00	\$ 2.60	\$ 4.10

Mugs & Cups



CODE	75CW	96CW
APPROX. CAPACITY	7.5 oz.	9.6 oz.
DESCRIPTION	Stacking Cup	Mug
CASE PACK	48	48
CASE LBS. (CUBE)	8 (0.69)	10.39 (0.97)
MAX DIA. / HEIGHT	4 $\frac{1}{16}$ " / 3 $\frac{3}{16}$ "	4 $\frac{3}{16}$ " / 3 $\frac{3}{4}$ "
FULL SIZE CAMRACK®	16C414	16C414
LIST PRICE EACH	\$ 3.95	\$ 3.95

Maximum diameter includes handle.

Camwear® Heat Keepers



	HK93CW	HK39
DESCRIPTION	3 COMPARTMENT BASE AND COVER	HEAT KEEPER BASE AND COVER FOR 9" PLATE
CASE PACK	6	6
CASE LBS. (CUBE)	9.25 (0.82)	10.56 (0.76)
LIST PRICE EACH	\$ 26.80	\$ 26.90

HK93CW is available in Beige (133).

HK39 is available in Antique White (148).

Camcarrier® for HK93CW available by special request. Call Cambro Customer Service for more information.

MEAL DELIVERY SYSTEM – THE SHORELINE COLLECTION

- System features a contemporary look and high performance.
- Unequaled safety at a budget-friendly price.
- The heart of the system is a high-density plastic, thermal warming pellet that:
- Can be heated in a base heater or conventional oven.
- Holds heat at its core to keep hot foods at safe temperatures above 149°F (65°C) for over 1 hour.
- Stays 20°F (6,7°C) cooler on the edge than metal pellets to protect staff and patients from burns.

Colors: Cranberry (487), Navy Blue (497), Speckled Gray (480), Black (110).

Capacities calculated to rim.

MDS9, MDSPL & 100TS not NSF.



100TS

COLORS:



Cranberry (487)



Navy Blue (497)



Speckled Gray (480)



Black (110)



Entrée System



Dome Cover features contoured handle for easy lifting.

Thermal Warming Pellet maintains safe temperatures over 149°F (65°C) for over 1 hour.

Pellet Underliner holds pellet securely.



Safely lift hot, thermal pellets with the Cambro Pellet Lifter.



Camshelving® Dome Drying and Storage Cart holds 100 each domes and/or pellet underliners. For more information refer to Camshelving section.

Entrée System Heat Retention

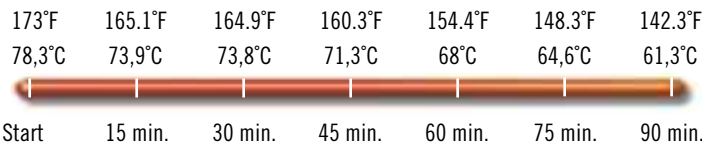

CODE	CLSM8B5190	CLS89190	CLSM8B5148
DESCRIPTION	Sm. Disp. Lid	Lg. Disp. Lid	Disp. Sip. Lid
FITS	MDSB5, MDSM8	MDSB9	MDSB5, MDSM8
OUTSIDE DIAMETER	3½"	4¾"	3½"
HEIGHT	¾"	¾"	1¼"
CASE PACK	1500	1000	1000
CASE LBS. (CUBE)	7.74 (2.43)	7.1 (2.1)	7.07 (2.08)
LIST PRICE	\$ 93.00**	\$ 78.00**	\$ 78.00**

**Prices are per case.

CODE	MDSM8	MDSB5	MDSB9	MDS9	MDSL9	MDSP9	MDSPL	100TS
DESCRIPTION	Mug	Sm. Bowl	Lg. Bowl	Insulated Dome	Pellet Underliner	Thermal Pellet	Pellet Lifter	Thermal Server
APPROX. CAPACITY	8 oz.	5 oz.	9 oz.	9" plate	9½" pellet	—	—	10 oz.
OUTSIDE DIAMETER	3½" *	3½"	4¾"	10¾"	9½"	9½"	3½"	—
HEIGHT	4"	2¾"	2¾"	2¾"	1¼"	1¼"	3"	—
FULL-SIZE CAMRACK®	16C414	16C414	9S318	PR59314	PR59314	PR59314	—	—
CASE PACK	48	48	48	12	12	12	1	6
CASE LBS. (CUBE)	11.5 (1.55)	7.4 (0.94)	10.07 (1.4)	10.75 (1.43)	5.25 (0.47)	29.90 (0.64)	0.4 (0.03)	4.03 (0.36)
LIST PRICE	\$ 2.85	\$ 2.85	\$ 2.85	\$ 17.65	\$ 8.00	\$ 41.30	\$ 78.00	\$ 15.75

* MDSM8 Diameter 4½" with Handle MDSP9 Color: Dark Gray (477). MDSPL Color: (000). 100TS Color: Black (110).

CAMWEAR® POLYCARBONATE & POLYETHYLENE CAMCOVERS®

Camwear Camcovers

- Food stays hot and appetizing without re-heating.
- Ideal for use in heated carts up to 210°F (99°C).
- Virtually unbreakable polycarbonate will not dent or scratch.
- Lightweight for quiet service.
- Saves on labor with no polishing required.

Colors: Clear (152), Amber (153), Beige (133), Silver (486)

For help selecting the correct size plate cover, refer to the Camcover Sizing Guide on our website at www.cambro.com. Or, send one of your plates to Cambro Customer Service for sizing.



CODE	INSIDE DIAMETER	OUTSIDE HEIGHT	CASE LBS. (CUBE)	LIST PRICE EA.
806CW	8 ⁷ / ₁₆ "	2 ¹¹ / ₁₆ "	5.45 (0.61)	\$ 9.05
900CW	9 ⁹ / ₁₆ "	2 ³ / ₄ "	5.75 (0.60)	9.10
901CW	9 ⁵ / ₁₆ "	2 ¹³ / ₁₆ "	6.40 (0.62)	9.70
905CW	9 ¹ / ₂ "	2 ¹³ / ₁₆ "	7.75 (0.64)	10.00
909CW	9 ³ / ₄ "	2 ³ / ₄ "	6.58 (0.64)	9.95
9011CW	10"	2 ⁷ / ₈ "	6.42 (0.78)	10.85
9013CW	10"	2 ³ / ₄ "	7.62 (0.65)	10.85
1000CW	10 ³ / ₁₆ "	2 ¹¹ / ₁₆ "	7.25 (0.68)	10.80
1005CW	10 ⁹ / ₁₆ "	2 ¹³ / ₁₆ "	7.73 (0.76)	11.00
1007CW	10 ⁵ / ₈ "	2 ³ / ₄ "	8.66 (0.78)	11.00
1013CW	10 ¹³ / ₁₆ "	2 ¹¹ / ₁₆ "	7.92 (0.78)	11.05
1101CW	11"	2 ¹¹ / ₁₆ "	7.81 (0.79)	11.00
1202CW	12 ¹ / ₈ "	2 ³ / ₄ "	8.76 (0.95)	11.05

Case Pack: 12

Polyethylene Camcovers

Colors: Terra Cotta (126), Taupe (127).

- Economical covers retain heat better than metal covers.
- Made of impact resistant polyethylene.
- Deliver years of dependable service without scratching or denting.
- Quiet, lightweight and easy to handle.
- Preheating not required.



CODE	INSIDE DIAMETER	OUTSIDE HEIGHT	CASE LBS. (CUBE)	LIST PRICE EA.
901P	9 ⁹ / ₁₆ "	2 ³ / ₄ "	5.16 (0.61)	\$ 6.90
1005P	10 ⁹ / ₁₆ "	2 ¹³ / ₁₆ "	6.22 (0.78)	8.20
1007P	10 ¹ / ₂ "	2 ¹¹ / ₁₆ "	6 (0.78)	8.20
1013P	10 ⁵ / ₈ "	2 ¹¹ / ₁₆ "	5.65 (0.78)	8.20
1101P	10 ¹⁵ / ₁₆ "	2 ¹¹ / ₁₆ "	6.25 (0.78)	8.20

Case Pack: 12

VERSA® CAMCOVERS

Serve hot food hot with the Versa Camcover, an elegant and efficient alternative to traditional metal covers.

- Withstands temperatures up to 300°F (149°C).
- Covers remain cool to the touch for easy handling.
- Lighter and quieter than metal covers.
- Elegant appearance without polishing.
- Non-porous material remains odor-free and stain resistant.
- Keeps food warm longer than metal covers.
- Microwave safe.

For help selecting the correct size plate cover, refer to the Camcover Sizing Guide on our website at www.cambro.com. Or, send one of your plates to Cambro Customer Service for sizing.

Colors: Ivory (197), Granite Gray (191), Antique Parchment (101).



Square Plate Covers



1111SQVS Fits 11" Syracuse Quadra Plate



85SFVS Fits 8½" Oneida Sant' Andrea Fusion Plate



99SMVS Fits 9" Steelite Distinction Metro Plate

1212SQVS Fits 12" Syracuse Quadra Plate

978SFVS Fits 9¾" Oneida Sant' Andrea Fusion Plate

1111SMVS Fits 11" Steelite Distinction Metro Plate

CODE	INSIDE DIAMETER	OUTSIDE HEIGHT	CASE LBS. (CUBE)	LIST PRICE EA.
Square				
1111SQVS	11½"	2⅞"	14.25 (0.72)	\$ 13.90
1212SQVS	12⅞"	2¾"	15.50 (0.87)	18.50
99SMVS	9½"	2⅝"	10.00 (0.48)	11.60
1111SMVS	11½"	2¾"	14.00 (0.73)	13.90
85SFVS	8½"	2¾"	10.75 (0.43)	11.60
978SFVS	10"	2¾"	13.25 (0.59)	11.80
Round				
68VS	6½"	2⅜"	5.16 (0.46)	\$ 9.80
86VS	8¼"	2⅝"	10 (0.47)	10.85
91VS	9½"	2⅞"	9.58 (0.52)	11.60
913VS	9⅜"	2⅞"	11.92 (0.51)	11.60
95VS	9⅝"	2⅞"	9.62 (0.52)	11.60
99VS	9⅞"	2⅝"	11.65 (0.52)	11.60
911VS	9⅜"	2¾"	10.60 (0.63)	11.95
100VS	10"	2⅞"	11.4 (0.52)	11.80
103VS	10⅜"	2⅞"	10.87 (0.57)	12.20
105VS	10⅝"	2⅞"	12.66 (0.59)	12.20
106VS	10⅜"	2⅞"	12.75 (0.72)	13.65
107VS	10⅞"	2⅞"	10.25 (0.74)	12.60
1010VS	10⅝"	2⅞"	13.54 (0.60)	12.90
1012VS	10¾"	2⅞"	13.74 (0.58)	12.90
1013CRVS	10⅜"	3⅞"	12.32 (0.68)	12.90
1014VS	10⅞"	2⅞"	13.02 (0.59)	12.90
116VS	11⅞"	3⅞"	14.49 (0.67)	13.90
120VS	12"	2⅞"	15.25 (0.77)	17.80
124VS	12¼"	2⅞"	14.56 (0.95)	18.50

Case Pack: 12



Microwave safe!



Perfect for heated carts!

CAMWEAR® POLYCARBONATE PITCHERS

- Made of virtually unbreakable Camwear polycarbonate.
- Lightweight for easy handling.
- Exclusive ice-control contoured lip and pour spout reduce spills.
- Slotted base allows for complete and sanitary drying.

Color: Clear (135). P600CW is also available in Amber (153).

Capacities calculated to rim.



1.800.833.3003

37

www.cambro.com

P320CW, P480CW and P600CW
An industry standard. Broad base for stability, prevents tipping.



CODE	P320CW	P480CW	P600CW
CAPACITY	32 oz.	48 oz.	60 oz.
HEIGHT WITH SPOUT	6¾"	7⅞"	8"
DIAMETER WITH HANDLE	5¾"	6¼"	6¾"
CASE LBS. (CUBE)	3.75 (0.61)	4.79 (0.79)	5.48 (0.93)
LIST PRICE EACH	\$ 9.90	\$ 11.95	12.65

Case Pack: 6

InStock Color: Clear (135).

PL60CW

Laguna pitcher has a hammered texture that hides scratches. Design matches the Laguna Tumbler. Pour liquids from front or ice and liquid from sides.

P64CW

Tapered design and drip-proof spout.

P60CW

Contemporary styling. Broad base for stability prevents tipping.

PC64CW

Three position lid can strain ice, free pour or close to protect contents.



CODE	PL60CW	P64CW	P60CW	PC64CW
CAPACITY	60 oz.	64 oz.	60 oz.	64 oz.
HEIGHT WITH SPOUT	7⅞"	9¼"	9"	9¾" with lid
DIAMETER WITH HANDLE	6¾"	7⅞"	7¼"	7⅞"
CASE LBS. (CUBE)	4.43 (1.15)	6.75 (1.31)	6.43 (1.04)	7.21 (1.19)
LIST PRICE EACH	\$ 8.65	\$ 14.60	\$ 14.60	\$ 18.75

Case Pack: 6

InStock Color: Clear (135).

ALISO® BARWARE & GOBLETS

Aliso Barware replicates the look, heft and clarity of glass with shatter-proof polycarbonate. The smooth seamless appearance makes Aliso Barware a stylish choice for casual dining, outdoor events or poolside service.

- Barware items have large, heavy bases for stability.
- Bases designed for fast draining and complete drying.
- Chill or frost barware without concerns of thermal shock damage.

Color: Clear (135).

Capacities calculated to rim.



CODE	BWM10CW	BWW10CW	BWP14CW	BWB16CW	GB850CW	GB1200CW
DESCRIPTION	Martini	Wine	Pilsner	Beer Mug	Goblet	Goblet
MAX DIAMETER	4 ³ / ₈ "	2 ⁵ / ₈ "	3 ¹ / ₄ "	4 ³ / ₈ "	2 ³ / ₄ "	2 ³ / ₄ "
MAX HEIGHT	6 ⁷ / ₈ "	6 ³ / ₄ "	9 ⁵ / ₈ "	6 ³ / ₄ "	6 ³ / ₄ "	7 ⁷ / ₈ "
FULL SIZE CAMRACK®	9S638	25S638	25S958	16S638	36S534	36S738
CAPACITY TO RIM	10.5 oz.	10.5 oz.	15.5 oz.	16 oz.	9 oz.	12.8 oz.
CASE PACK	12	24	24	12	24	24
CASE LBS. (CUBE)	6.50 (1.38)	8.25 (1.16)	15.78 (1.71)	9 (0.85)	5.42 (0.83)	6.74 (0.97)
LIST PRICE EA.	\$ 10.30	\$ 8.10	\$ 11.15	\$ 10.70	\$ 3.85	\$ 4.55

InStock Color: Clear (135).

CAMBRO® TUMBLERS

Cambro tumblers feature the look and feel of glass, but offer the cost savings and lightweight handling of break resistant plastic. These tumblers weigh up to 50% less than glass, making it easier and safer for wait staff to carry and serve beverages. Cambro tumblers cost about 33% less than comparable

glassware. Less breakage means lower replacement costs and less staff time spent cleaning up broken glass. Cambro tumblers feature stacking lugs for easy stacking, transport and storage and are dishwasher safe.

Expand your service options! Valued by restaurants, hospitals, hotels and

schools, Cambro tumblers are ideal anywhere you want the upscale look of glass without the worry of breakage. Our elegant designs are ideal for outdoor catering and resort use. Whatever your need, there is a Cambro tumbler perfect for your operation.

Elegant Design



HUNTINGTON®
Elegant Design, Unbreakable



LAGUNA®
Hammered Texture



NEWPORT
Fluted Design



DEL MAR®
Crackled Glass Look

RECOMMENDED USE: Casual Dining, Fast Casual Dining, Poolside Service, Outdoor Dining, Catering, Bars, Hotels & Resorts, Country Clubs, Theme Parks, Cruise Ships, Colleges & Universities.

All Purpose



COLORWARE
Value Tumbler



CAMWEAR®
Virtually Unbreakable



PERSONALIZATION
Available on all tumblers



Add your logo to promote your establishment and build customer loyalty. See personalization page for details.

RECOMMENDED USE: Family Dining, Pizzerias, Cafeterias, Hospitals & Nursing Homes, Colleges & Universities.

CAMWEAR® HUNTINGTON® & NEWPORT TUMBLERS

Huntington Tumblers

- Feature the elegant look and feel of glass without the high replacement costs.
- Made of virtually unbreakable polycarbonate.
- Lightweight.
- Stacking lugs to prevent sticking.
- Three sided drain bottom for easy washing and drying.

Colors: Azure Blue (196), Clear (135).

Capacities calculated to rim.

Huntington Tumblers are covered by the following U.S. Patents D 386,047, D 375,871 & D 375,657.



CODE	HT5CW	HT8CW	HT10CW	HT120CW	HT12CW	HT14CW	HT16CW	HT22CW
MAX DIAMETER	2 1/32"	2 1/16"	2 13/16"	3"	3 3/8"	3 1/4"	3 5/16"	3 1/2"
MAX HEIGHT	3 3/16"	4 1/16"	4 13/16"	5"	3 3/4"	4 7/8"	5 1/2"	6 11/16"
FULL SIZE CAMRACK®	49S318	36S418	36S434	25S434	25S418	25S434	25S534	25S638
CAPACITY TO RIM	5 oz.	8 oz.	10 oz.	12 oz.	12 oz.	14 oz.	16 oz.	22 oz.
CASE LBS. (CUBE)	3.86 (0.27)	5.22 (0.39)	7.2 (0.43)	7.18 (0.52)	6.98 (0.63)	3.42 (0.58)	8.50 (0.70)	10.55 (0.87)
LIST PRICE EACH	\$ 2.39	\$ 2.50	\$ 2.60	\$ 2.72	\$ 2.67	\$ 2.99	\$ 3.48	\$ 4.35

Case Pack: 36

InStock Color: Clear (135).

Newport Tumblers

- Fluted design features the upscale look of glass with the safety benefits and cost savings of plastic.
- Impact resistant SAN plastic resists chips and breaks.
- Stacking lugs prevent sticking.
- Sani-Rim lip provides a sanitary drinking surface.

Colors: Clear (152), Blush (409), Amber (153), Slate Blue (401).

Capacities calculated to rim.

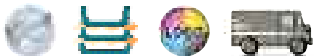

CODE	NT5	NT8	NT9	NT10	NT12	NT14	NT16	NT20
MAX DIAMETER	2 1/2"	2 11/16"	3 1/4"	2 13/16"	3"	3 3/8"	3 1/4"	3 7/16"
MAX HEIGHT	3 11/16"	4"	3 3/8"	4 9/16"	5 3/8"	5"	5 3/4"	6 1/2"
FULL SIZE CAMRACK	36S318	36S418	25S318	36S434	25S434	25S434	25S534	25S638
CAPACITY TO RIM	6.4 oz.	7.7 oz.	9.3 oz.	10 oz.	12.6 oz.	14 oz.	16.4 oz.	22 oz.
CASE LBS. (CUBE)	3.6 (0.31)	4.3 (0.34)	4.4 (0.36)	5.26 (0.45)	5.62 (0.49)	6.1 (0.54)	6.8 (0.60)	8.6 (0.76)
LIST PRICE EACH	\$ 1.30	\$ 1.34	\$ 1.47	\$ 1.60	\$ 1.66	\$ 1.93	\$ 1.98	\$ 2.45

Case Pack: 36

InStock Color: Clear (152).

LAGUNA® & DEL MAR® TUMBLERS

Laguna Tumblers

- Hammered texture hides water spots and scratches.
- Made of impact resistant SAN.
- Lightweight and easy to carry.

Colors: Clear (152), Spanish Green (427).

Capacities calculated to rim.

Laguna Tumblers are covered by the following U.S. Patent D 405,319.



CODE	LT6	LT8	LT10	LT12	LT14	LT16	LT22
MAX DIAMETER	2½"	2¾"	2⅝"	3⅝"	3¼"	3⅜"	3⅞"
MAX HEIGHT	4¼"	4¼"	4¾"	5"	5⅝"	5½"	6⅞"
FULL SIZE CAMRACK®	36S418	36S418	36S434	25S434	25S434	25S534	16S534
CAPACITY TO RIM	6 oz.	8 oz.	10 oz.	12 oz.	14 oz.	16 oz.	22 oz.
CASE LBS. (CUBE)	4.28 (0.37)	5.10 (0.44)	5.50 (0.55)	6.44 (0.61)	6.55 (0.7)	8 (0.82)	10.09 (1.05)
LIST PRICE EACH	\$ 1.62	\$ 1.77	\$ 1.84	\$ 2.01	\$ 2.13	\$ 2.35	\$ 2.65

Case Pack: 36

InStock Color: Clear (152).

Del Mar Tumblers

- Crackled glass look features the lightweight handling of plastic.
- Thick sturdy base and rolled rim edge for added stability.
- Made of impact resistant SAN plastic.

Colors: Clear (152), Ruby Red (156), Sapphire Blue (608), Light Amber (609).

Capacities calculated to rim.

Del Mar Tumblers are covered by the following U.S. Patent D 478,778 S.



CODE	D8	D12	D14	D16	D24
MAX DIAMETER	2⅝"	2⅝⅞"	3¼"	3⅜"	3⅞"
MAX HEIGHT	4⅜"	4¾"	4⅝"	5⅝⅞"	6⅞"
FULL SIZE CAMRACK	36S418	25S434	25S318	25S534	25S638
CAPACITY TO RIM	8 oz.	12 oz.	14 oz.	16 oz.	24 oz.
CASE LBS. (CUBE)	4.75 (0.35)	6.63 (0.49)	7.50 (0.62)	8.50 (0.66)	11.13 (0.91)
LIST PRICE EACH	\$ 1.25	\$ 1.32	\$ 1.62	\$ 1.67	\$ 2.16

Case Pack: 36

InStock Color: Clear (152).

COLORWARE TUMBLERS

- A classic value tumbler ideal for casual dining.
- Textured on the outside to resist scratching.
- Made of impact resistant SAN.
- Interior stacking lugs for easy storing.
- Sani-Rim lip provides a sanitary drinking surface.

Colors: Blush (409), Slate Blue (401), Clear (152), Amber (153), Ruby Red (156).

Capacities calculated to rim.



CODE (72 PACK)	500P	800P	900P	950P	1200P	1600P	2000P	—
CODE (24 PACK)	500P2	800P2	900P2	950P2	1200P2	1600P2	2000P2	3200P2
MAX DIAMETER	2¼"	2⅝"	3⅜"	2¾"	2⅝"	3⅜"	3⅝"	3⅝"
MAX HEIGHT	3⅝"	4"	3¼"	4⅝"	5⅝"	5¾"	6½"	7¼"
FULL SIZE CAMRACK®	49S318	36S418	25S318	36S418	25S434	25S534	25S638	16S738
CAPACITY TO RIM	5.2 oz.	7.8 oz.	9.7 oz.	9.8 oz.	12.6 oz.	16.4 oz.	22 oz.	32 oz.
P CODE-CASE PACK	72	72	72	72	72	72	72	—
P2 CODE-CASE PACK	24	24	24	24	24	24	24	24
72 PACK-CASE LBS. (CUBE)	7.56 (0.46)	7.89 (0.56)	8.45 (0.69)	9.54 (0.73)	5.04 (0.84)	14.76 (1.07)	17.25 (1.30)	—
24 PACK-CASE LBS. (CUBE)	2.17 (0.16)	2.75 (0.20)	2.91 (0.23)	3.30 (0.25)	3.86 (0.28)	4.75 (0.54)	5.81 (0.45)	7.91 (0.72)
LIST PRICE EACH - 72 PACK	\$ 0.86	\$ 1.03	\$ 1.74	\$ 1.20	\$ 1.34	\$ 1.58	\$ 1.96	—
LIST PRICE EACH - 24 PACK	\$ 0.92	\$ 1.12	\$ 1.90	\$ 1.31	\$ 1.41	\$ 1.68	\$ 2.13	\$ 3.17

InStock Color: Clear (152).

Coca-Cola® Tumblers

- Colorware Tumblers featuring the Coca-Cola trademark logo in White.
- Available only to Coca-Cola fountain customers for foodservice use.

Colors: Ruby Red (156), Clear (152).

Coca-Cola Logo is imprinted in White only.

These trademarked tumblers may not be resold at retail and are available only for distribution to Coca-Cola Fountain customers for food service use.



CODE	20CC	32CC
MAX DIAMETER	3⅝"	3⅝"
MAX HEIGHT	6½"	7¼"
FULL SIZE CAMRACK	25S638	16S738
CAPACITY TO RIM	22 oz.	32 oz.
CASE PACK	72	24
CASE LBS. (CUBE)	17.25 (1.30)	7.85 (0.70)
LIST PRICE EA. 72 PACK	\$ 2.31	—
LIST PRICE EA. 24 PACK	—	\$ 3.47

CAMWEAR® TUMBLERS & CAMLITERS®

Camwear Tumblers

- The look and feel of glass but made of virtually unbreakable polycarbonate.
- Textured exterior surface resists scratching.
- Smooth interior promotes easy cleaning.
- Designed with a Sani-Rim lip for sanitary drinking.

Colors: Clear (152), Amber (153).
1200CW & 1600CW are available in Red (156).

Capacities calculated to rim.



CODE	500CW	800CW	850CW	950CW	1200CW	1600CW
MAX DIAMETER	2¼"	2½"	3⅜"	2¾"	2½⅙"	3⅜"
MAX HEIGHT	3⅜"	3⅞"	3⅓⅙"	4⅜"	5⅓⅙"	5¾"
FULL SIZE CAMRACK®	49S318	36S418	25S418	36S418	36S434	25S534
CAPACITY TO RIM	5.4 oz.	8 oz.	9.1 oz. (Heavy Wall)	9.6 oz.	13 oz.	17 oz.
CASE LBS. (CUBE)	4.24 (0.28)	5.53 (0.42)	9.50 (0.61)	6.50 (0.52)	8.25 (0.67)	9.50 (0.80)
LIST PRICE EACH	\$ 1.45	\$ 1.75	\$ 4.50	\$ 2.05	\$ 2.30	\$ 2.85

Case Pack: 48

Camwear Camliter Beverage Decanters

- Ideal for serving juice or wine on buffet lines or table side.
- Virtually unbreakable Camwear polycarbonate will not dent or scratch. Lightweight.
- Camlitters ship with spill-proof flat lids.
- Pour Spout Lid, ordered separately, protects contents while allowing a free pour.

Color: Clear (135).
Lid Color: White (148).



CODE	CAPACITY	HEIGHT	CASE LBS. (CUBE)	LIST PRICE EA.
Camlitters with Flat Lids				
WW1500CW	1½ L	10"	8.04 (1.56)	\$ 12.95
WW1000CW	1 L	9¾"	7 (1.13)	9.95
WW500CW	½ L	7⅞"	4.25 (0.69)	7.35
WW250CW	¼ L	6¼"	2.14 (0.32)	4.45
Lids				
WW1000LS (Pour Spout Lid for 1½ L, 1 L, and ½ L)			.2 (0.11)	0.95
WW1000L (Replacement Lid for 1½ L, 1 L and ½ L)			.62 (0.06)	0.95
WW250L (Replacement Lid for ¼ L)			.13 (0.06)	0.95

Case Pack: 12 InStock Color: Clear (135).



WW1000L - Flat Lid



WW1000LS - Pour Spout



BEVERAGE DISPENSER, PAIL WITH BAIL & SWIRL BOWLS®

6-Gallon Beverage Dispenser

- Perfect for mixing and serving concentrated beverages.
- Standard and metric graduations are printed on dispenser.
- Impact resistant polyethylene withstands temperatures from -40°F to 160°F (-40°C to 70°C).

CODE	CASE LBS. (CUBE)	LIST PRICE EA.
DSPR6	3.79 (1.52)	\$ 40.60

Case Pack: 1 Color: White (148).
DSPR6 Capacity: 6 gallons (22,7 L).



44

Pail with Bail – Poly

- A large, multi-purpose, 22 quart (20,8 L) pail, ideal for mixing, storing and transporting.
- Durable polyethylene withstands temperatures from -40°F to 160°F (-40°C to 70°C), and is stain resistant.
- Snap-tight, thumb tab cover sold separately.

CODE	CASE LBS. (CUBE)	LIST PRICE EA.
PWB22	14.43 (3.29)	\$ 23.30
RFSC12(cover)	3.75 (0.42)	4.55

Case Pack: 6 Color: White (148).
All graduations are approximate.



Swirl Bowls

- Ideal for hot or cold side dishes, desserts, dips, or fruit.
- Fits on a plate or stacks in place on a buffet station.
- Available in virtually unbreakable Camwear® polycarbonate or break resistant SAN.

Colors:
SRB5CW and SRB13CW available in:
Clear (135), Black (110), White (148).
SRB5 and SRB13 available in:
Clear (152), Black (110), White (148).



CODE	CAPACITY	CASE LBS. (CUBE)	LIST PRICE EA.
Camwear Polycarbonate			
SRB5CW	5 oz.	3 (0.23)	\$ 2.10
SRB13CW	13 oz.	5.15 (0.33)	4.10
SAN			
SRB5	5 oz.	3 (0.23)	1.65
SRB13	13 oz.	4.46 (0.33)	3.05

Case Pack: 24

CAMWEAR® WINE BUCKETS, PUNCH BOWLS & BUD VASE

Wine Buckets

- Chill and showcase wine or champagne.
- Tough Camwear polycarbonate won't crack or break and is easy to clean.
- Chrome stand available for space saving table side service.

Color: Clear (135).
Stand Color: Chrome (136).



CODE	SIZE D X H	CASE LBS. (CUBE)	LIST PRICE EA.
Bucket			
WC100CW	8" x 9½"	2 (0.50)	\$ 37.90
WC100CWNH (without handles)	8" x 9"	1.74 (0.50)	21.80
Stand			
WCS30		4 (1.59)	92.15

Case Pack: 1

Pebbled Pedestal Punch Bowls

- Perfect for parties, weddings and receptions.
- Made of virtually unbreakable Camwear polycarbonate.
- Attractive pebbled exterior is scratch resistant and smooth interior is easy to clean.

Color: Pebbled (176).

Capacities are calculated to rim.



CODE	INSIDE DIAMETER	APPROX. CAPACITY	CASE LBS. (CUBE)	LIST PRICE EA.
PPB15	15"	11.2 qt.	2.6 (1.27)	\$ 68.90
PPB18	18"	20.2 qt.	4.6 (2.12)	90.90
PPB23	23"	40.0 qt.	8.3 (4.38)	156.35

Case Pack: 1

Bud Vase

- Ideal for dining rooms, cafeteria tables and patient or room service trays.
- Made of virtually unbreakable Camwear polycarbonate.
- Fill with a fresh rose bud or a colorful faux flower.

Colors: Clear (135), White (148).

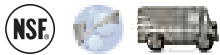

CODE	DESCRIPTION	CASE LBS. (CUBE)	LIST PRICE EA.
BV6CW	6" Bud Vase	2.21 (0.36)	\$ 3.25

Case Pack: 12



DISPLAY

- Deli Crocks & Platters
- ShowFest® Display Bowls & Trays
- Market Trays & Pans
- Serving Bowls
- Display Covers & Trays
- Crocks
- Ladles
- Serving Spoons
- High Heat Camtensils®
- Tongs
- Shakers/Dredges
- Condiment Jars



DELI CROCKS & PLATTER

- Prep, store and serve all in one with contemporary style at an economical price.
- Crock and platter are made of SAN, making them impact, stain and chip resistant.
- Ideal for supermarket delis, sandwich shops, buffets and catered events.
- Handled covers are made of crystal clear, virtually unbreakable Camwear® polycarbonate.

Crock and Platter Colors: Clear (152), Black (110), White (148), Red (404).

Crock Cover Color: Clear (135)

Deli Crock covers are covered by the following U.S. Patents D 504,283 S, D 503,871 S & D 494,419 S. Scalloped Food Service Cover is covered by the following U.S. Patent D 509,795 S.



Prep, stack, store and serve all in one.



Interstacking saves storage space.



Avoid cross contamination and keep food fresh by using clear cover with handle.



Lid can be used as a riser to provide additional height on the buffet table or in a deli display case.



Cover doubles as a false bottom for presentation and to reduce waste.

Crocks & Platter



CODE	DC5	DC10	DP15
DESCRIPTION	Crock	Crock	Platter
DIM. W x D x H	10 ⁵ / ₁₆ " x 6 ¹³ / ₁₆ " x 3 ³ / ₁₆ "	13 ³ / ₁₆ " x 10 ⁷ / ₁₆ " x 3 ³ / ₁₆ "	11 ¹ / ₁₆ " x 15 ³ / ₄ " x 2 ³ / ₁₆ "
APPROX. CAPACITY	2.2 qts.	4.9 qts.	3.4 qts.
CASE LBS. (CUBE)	3.93 (0.30)	7.1 (1.4)	6.25 (0.49)
LIST PRICE EACH	\$ 9.75	\$ 13.45	\$ 11.90

Case Pack: 6

Covers



CODE	DCC5 fits DC5	DCC10 fits DC10
DIM. W x D x H	9 ³ / ₈ " x 5 ⁷ / ₈ " x 1 ¹ / ₁₆ "	12 ³ / ₁₆ " x 9 ⁹ / ₁₆ " x 1 ¹ / ₁₆ "
APPROX. CAPACITY	.90 qts.	2.0 qts.
CASE LBS. (CUBE)	2.50 (0.21)	5 (0.38)
LIST PRICE EACH	\$ 6.85	\$ 9.50

Case Pack: 6



SHOWFEST® DISPLAY BOWLS & TRAYS

- Showcase cold deli, buffet and salad bar items.
- Made from SAN for impact, stain, break & chip resistance.
- Variety of shapes sizes to make the best use of display area.

Colors: Black (110), White (148).

Triangle trays are covered under U.S. Patent D 419,364.



Scalloped Ovals



CODE	SFV1015
DIM. W x L x H	10" x 15" x 2½"
APPROX. CAPACITY	3.0 qts.
CASE LBS. (CUBE)	4.8 (0.63)
LIST PRICE EACH	\$ 15.75

Case Pack: 6

Scalloped Rectangles



CODE	SFR1012
DIM. W x L x H	10" x 12½" x 3"
APPROX. CAPACITY	4.5 qts.
CASE LBS. (CUBE)	5.99 (0.46)
LIST PRICE EACH	\$ 15.10

Case Pack: 6



Octagonals



CODE	SFG1012	SFG1015	SFG820	SFG1220
DIM. W x L x H	10" x 12" x 2"	10" x 15" x 2"	8" x 20" x 2"	12" x 20" x 2"
APPROX. CAPACITY	3.0 qts.	3.5 qts.	4.0 qts.	6.0 qts.
CASE LBS. (CUBE)	5.16 (0.41)	6.25 (0.51)	6.64 (0.53)	9.82 (0.78)
LIST PRICE EACH	\$ 15.10	\$ 16.15	\$ 17.15	\$ 20.60

Case Pack: 6

Triangles



CODE	SFT1010	SFT1212	SFT1515
DIM. W x L x H	10" x 10" x 12" x 2½"	12" x 12" x 15" x 2½"	15" x 15" x 20" x 2½"
APPROX. CAPACITY	2.0 qts.	3.0 qts.	4.5 qts.
CASE LBS. (CUBE)	2.8 (0.40)	3.8 (0.54)	7.1 (0.82)
LIST PRICE EACH	\$ 14.30	\$ 15.50	\$ 17.95

Case Pack: 6

MARKET TRAYS & PANS

- Attractively merchandise desserts, pastries, hors d'oeuvres and salads.
- Ideal for use in bakeries, supermarkets and delis.
- High-impact resistant fiberglass with reinforced edges provide strength.
- Trays and pans resist odors and will not oxidize like aluminum trays.
- Pans feature a 2" (5 cm) rim for salads and ready to eat foods.

Colors: Salmon (149), Yellow (145), Blue (142), Green (140), White (148), Black (110).

Colors NSF listed for food contact: White (148), Blue (142), Green (140), Black (110).

* Special order item not carried in stock, non-returnable. One case order minimum.



Market Trays add appetite appeal to bakery displays.

CODE	DIMENSIONS W x L x H	CASE PACK	CASE LBS. (CUBE)	LIST PRICE EA.
Market Trays				
630MT*	6 ⁷ / ₁₆ " x 30" x 3 ³ / ₄ "	12	15.50 (0.63)	\$ 17.80
826MT*	8 ¹ / ₄ " x 25 ¹ / ₂ " x 3 ³ / ₄ "	12	17.50 (0.55)	14.60
830MT*	8 ⁷ / ₁₆ " x 30" x 3 ³ / ₄ "	12	20.75 (0.75)	20.15
918MT*	8 ¹¹ / ₁₆ " x 18" x 1 ¹³ / ₁₆ "	12	13 (0.48)	16.90
926MT*	8 ⁷ / ₈ " x 25 ⁹ / ₁₆ " x 1"	12	16.42 (0.78)	18.80
1015MT*	10 ¹ / ₈ " x 15" x 3 ³ / ₄ "	24	13.75 (0.85)	14.10
1030MT*	10 ¹ / ₁₆ " x 30" x 3 ³ / ₄ "	12	22.50 (0.83)	22.25
1218MT*	11 ¹ / ₂ " x 17 ³ / ₄ " x 1"	12	15.50 (0.63)	17.60
1224MT*	12 ¹ / ₁₆ " x 24" x 3 ³ / ₄ "	12	22.50 (0.90)	22.05
1227MT*	12 ¹ / ₁₆ " x 27" x 3 ³ / ₄ "	12	25.57 (0.88)	23.75
1230MT*	12 ¹ / ₁₆ " x 30" x 3 ³ / ₄ "	12	28 (1.01)	25.60
1318MT*	12 ⁵ / ₈ " x 17 ³ / ₄ " x 1 ¹ / ₁₆ "	12	19 (0.80)	18.05
1826MT*	17 ¹³ / ₁₆ " x 25 ¹¹ / ₁₆ " x 1 ¹ / ₁₆ "	6	16.58 (0.88)	28.75
2025MT*	20 ³ / ₄ " x 25 ⁵ / ₁₆ " x 1 ¹³ / ₁₆ "	6	21 (0.80)	37.70



Market Pans showcase deli items.

CODE	DIMENSIONS W x L x H	CASE LBS. (CUBE)	LIST PRICE EA.
Market Pans			
6302MT*	6 ⁵ / ₁₆ " x 30" x 2"	17.52 (0.72)	\$ 27.95
8262MT*	8 ³ / ₈ " x 25 ¹ / ₂ " x 2"	21 (0.93)	22.90
8302MT*	8 ³ / ₁₆ " x 30" x 2"	26.50 (0.98)	30.75
92615MT*	8 ³ / ₈ " x 25 ¹ / ₂ " x 1 ¹ / ₂ "	21.50 (0.70)	18.75
10302MT*	10 ¹ / ₁₆ " x 30" x 2"	28 (1.15)	32.90

Case Pack: 12

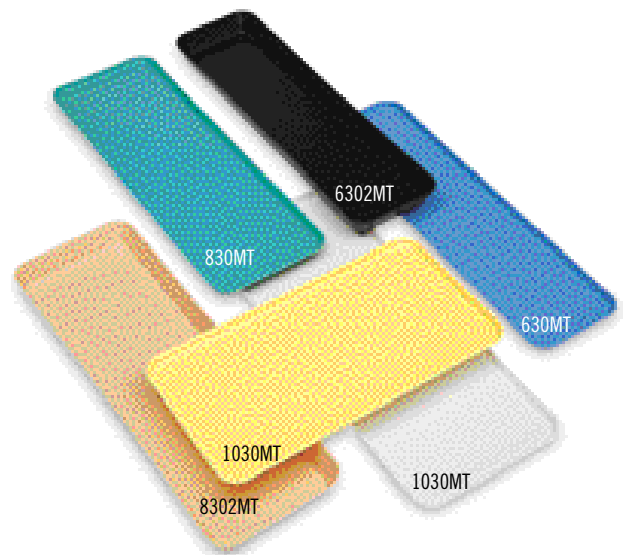

CAMWEAR® POLYCARBONATE BOWLS

Round Pebbled Bowls

- Textured on the outside for an elegant look, smooth on the inside for easy cleaning.
- Made of virtually unbreakable Camwear polycarbonate for years of dependable service.
- Ideal for fruit, salads, snacks and desserts.

Color: Pebbled (176).

Capacities are calculated to rim.



Ribbed Bowls

- Stylish, contemporary appearance for a dramatic presentation.
- Made of virtually unbreakable Camwear polycarbonate that won't break like glass.
- Bowls are durable and lightweight. Will not chip and crack like acrylic.
- Resistant to stains, acids and odors.

Colors: Clear (135), Black (110), White (148), Red (404)*.

*RSB6CW, RSB8CW and RSB10CW are available in Red (404).

Capacities are calculated to rim.



Round Pebbled Bowls



CODE	PSB6	PSB8	PSB10	PSB12
INSIDE DIAMETER	6"	8"	10"	12"
APPROX. CAPACITY	18.8 oz.	1.8 qt.	3.2 qt.	5.8 qt.
CASE PACK	12	12	12	12
CASE LBS. (CUBE)	2.50 (0.19)	4.43 (0.43)	9.25 (0.79)	12.75 (1.30)
LIST PRICE EACH	\$ 3.30	\$ 5.60	\$ 11.05	\$ 14.30

InStock Color: Pebbled (176).

Round Pebbled Bowls



CODE	PSB15	PSB18	PSB23
INSIDE DIAMETER	15"	18"	23"
APPROX. CAPACITY	11.2 qt.	20.2 qt.	40 qt.
CASE PACK	4	4	4
CASE LBS. (CUBE)	7 (1.19)	12.25 (2.09)	19.50 (4.08)
LIST PRICE EACH	\$ 23.30	\$ 37.10	\$ 56.50

InStock Color: Pebbled (176).

Rectangular Ribbed Bowls

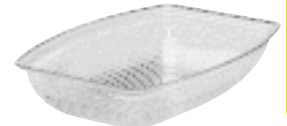

CODE	RSB912CW	RSB1014CW	RSB1419CW
OUTSIDE DIMENSIONS	9" x 12 $\frac{1}{8}$ "	10 $\frac{3}{4}$ " x 14 $\frac{1}{16}$ "	14 $\frac{1}{4}$ " x 19 $\frac{3}{8}$ "
APPROX. CAPACITY	2.9 qts.	5 qts.	12.0 qts.
CASE PACK	12	4	4
CASE LBS. (CUBE)	8.75 (0.66)	4.64 (0.51)	8.85 (1.11)
LIST PRICE EACH	\$ 11.70	\$ 17.15	\$ 27.80

Round Ribbed Bowls



CODE	RSB6CW	RSB8CW	RSB10CW	RSB12CW
INSIDE DIAMETER	6"	8"	10"	12"
APPROX. CAPACITY	18.8 oz.	1.65 qt.	3.2 qt.	5.8 qt.
CASE PACK	12	12	12	12
CASE LBS. (CUBE)	6.9 (0.2)	5.92 (0.51)	11.50 (0.91)	19.75 (1.69)
LIST PRICE EACH	\$ 4.20	\$ 8.20	\$ 15.00	\$ 25.00



CODE	RSB15CW	RSB18CW	RSB23CW
INSIDE DIAMETER	15"	18"	22 $\frac{1}{8}$ "
APPROX. CAPACITY	11.2 qt.	20.2 qt.	40 qt.
CASE PACK	4	4	4
CASE LBS. (CUBE)	8.25 (1.32)	13.4 (2.05)	22 (4.00)
LIST PRICE EACH	\$ 32.30	\$ 46.55	\$ 70.10

InStock Color: Black (110).

BELL SHAPED, BUDGET & FIBERGLASS BOWLS

Camwear® Bell-Shaped Pebbled Bowls

- Perfect for showcasing fruits and salads.
- A versatile alternative to Cambro traditional Round Pebbled Bowls.
- Made from virtually unbreakable Camwear polycarbonate.

Color: Pebbled (176).

Capacities are calculated to rim.



CODE	BSB10	BSB12	BSB18
INSIDE DIAMETER	9 $\frac{7}{8}$ "	12"	18"
APPROX. CAPACITY	2.1 qt.	4.0 qt.	12.5 qt.
CASE PACK	12	4	4
CASE LBS. (CUBE)	7.25 (0.48)	4 (0.52)	9 (1.50)
LIST PRICE EACH	\$ 11.05	\$ 14.25	\$ 30.05

Color: Pebbled (176)

52

Budget Salad Bowls

- An economical serving choice for fruit, salads, snacks and desserts.
- Impact resistant FDA approved material resists stains, acids and odors.

Colors: Birch (174), Black (110).

Capacities are calculated to rim.

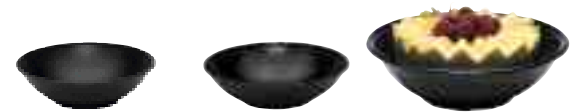

CODE	SB55	SB60	SB80
INSIDE DIAMETER	5 $\frac{1}{16}$ "	6"	8"
APPROX. CAPACITY	10.9 oz.	12.6 oz.	31.2 oz.
CASE LBS. (CUBE)	8.75 (0.56)	11 (0.54)	19.25 (1.07)
LIST PRICE EACH	\$ 1.65	\$ 2.00	\$ 3.95

Case Pack: 72



Fiberglass Bowls

- Combines the look of warm wood grains with the durability of fiberglass.
- Colors won't fade even after years of service and washing.

Colors: Light Basketweave (302), Dark Basketweave (301).

For swatches of these colors and patterns, see Camtray group section.

Capacities are calculated to rim.



CODE	6F	8F
INSIDE DIAMETER	6 $\frac{1}{8}$ "	8"
APPROX. CAPACITY	14.3 oz.	31.2 oz.
CASE LBS. (CUBE)	2.17 (0.15)	4.25 (0.23)
LIST PRICE EACH	\$ 10.60	\$ 12.30

Case Pack: 12



CAMWEAR® POLYCARBONATE DISPLAY COVERS & TRAYS

- Display covers protect freshness of pastries, breads and desserts.
- Virtually unbreakable Camwear polycarbonate features the upscale look of glass.
- Openings on side or end provide quick and easy access to contents without removing cover.

Display Covers

Color: Clear (135).

* Height on covers without handle.
Handle height is $1\frac{3}{16}$ ".



Display Trays are stackable.
Display Trays cannot be personalized.



RD1200CW



RD1220CW



RD1220CWH



DD1220BECW



Display Tray – DT1220CW



Dome with side cut – DD1220SCW

CODE	APPROXIMATE DIMENSIONS W x L x H*	DESCRIPTION	CASE PACK	CASE LBS. (CUBE)	LIST PRICE EA.
Display Covers					
RD1200CW	12"	Cake cover	1	2.14 (0.73)	\$ 27.75
DD1220CW	12" x 20" x 6 $\frac{5}{8}$ "	Dome cover	1	4.2 (1.56)	48.35
DD1220ECW	12" x 20" x 6 $\frac{5}{8}$ "	Dome w/end cut	1	3.76 (1.54)	61.10
DD1220BECW	12" x 20" x 6 $\frac{5}{8}$ "	Dome w/2 ends cut	1	3.6 (1.62)	74.45
DD1220SCW	12" x 20" x 6 $\frac{5}{8}$ "	Dome w/side cut	1	3.8 (1.75)	61.10
DD1826CW	18" x 26" x 7"	Dome cover	1	5.2 (2.73)	67.85
RD926CW	9" x 26" x 7"	Rectangular cover	1	3.29 (1.04)	45.05
RD1220CW	12" x 20" x 4 $\frac{5}{8}$ "	Rectangular cover	1	4.06 (1.11)	51.15
RD1220CWH	12" x 20" x 4 $\frac{5}{8}$ "	Rectangular w/hinge	1	4.14 (0.93)	72.80
RD1826CW	18" x 26" x 4 $\frac{3}{4}$ "	Rectangular cover	1	6 (1.93)	66.30
RD1826CWH	18" x 26" x 4 $\frac{3}{4}$ "	Rectangular w/hinge	1	5.84 (1.58)	77.40
Display Tray – Fits with all 1220 Covers					
DT1220CW	12" x 20"	Tray	1	0.86 (0.29)	19.50
Market Tray – Fits with all 1826 Covers					
1826MT**	17 $\frac{13}{16}$ " x 25 $\frac{11}{16}$ " x 1 $\frac{1}{16}$ "	Tray	6	16.58 (0.88)	28.75

CROCKS AND LADLES

Crocks

- Ideal for use with salad bars, on buffet tables or at food stations.
- Resists stains and odors caused by vinegar, salad oils, or mayonnaise.
- Made of high impact FDA accepted material.
- Smooth surface is easy-to-clean.

Solid Color Crock Colors:
Cranberry (416), Black (110), Beige (133),
Reddish Brown (195), White (148).
Lid Color: White (148).
Clear Crock Color: Clear (152).

*Lids for Solid Color and Clear Crocks are not interchangeable.



CODE	CAPACITY	CASE PACK	CASE LBS. (CUBE)	LIST PRICE EA.
------	----------	-----------	------------------	----------------

Solid Color Crocks

CP12	1.2 Quart w/Lid	12	7 (1.07)	\$ 7.40
CP15	1.5 Quart w/Lid	6	4.2 (0.71)	9.20
CP27	2.7 Quart w/Lid	6	6 (1.13)	10.50

Lids For Solid Color Crocks

CPL12*	Fits Colored CP12 Crock	12	0.8 (0.08)	1.30
CPL27*	Fits Colored CP15 & CP27	12	1.03 (0.13)	1.35

Clear Crocks

CCP12	1.2 Quart w/Lid	12	8 (1.07)	8.45
CCP15	1.5 Quart w/Lid	6	5 (0.69)	13.25
CCP27	2.7 Quart w/Lid	6	6.25 (1.15)	14.10

Lids For Clear Crocks

CCPL12*	Fits Clear CCP12 Crock	12	6.16 (0.08)	1.25
CCPL27*	Fits Clear CCP15 & CCP27	12	13.27 (0.13)	1.30

CODE	HEIGHT	TOP DIAMETER	CUT OUT DIAMETER
------	--------	--------------	------------------

Solid Color Crock with Lid

CP12	5 $\frac{5}{16}$ "	5 $\frac{5}{16}$ "	4 $\frac{3}{4}$ "
CP15	4 $\frac{4}{16}$ "	6 $\frac{3}{8}$ "	6 $\frac{3}{16}$ "
CP27	6 $\frac{3}{4}$ "	6 $\frac{3}{8}$ "	6 $\frac{3}{8}$ "

Clear Color Crock with Lid

CCP12	5 $\frac{5}{8}$ "	5 $\frac{1}{4}$ "	4 $\frac{7}{8}$ "
CCP15	4 $\frac{3}{8}$ "	6 $\frac{3}{4}$ "	6 $\frac{1}{4}$ "
CCP27	6 $\frac{3}{8}$ "	6 $\frac{3}{4}$ "	6 $\frac{3}{16}$ "

InStock Color: Black (110).

Camwear® Ladles

- Portion control bowls serve the perfect amount of dressing or food ingredient.
- Angled for easy handling.
- Designed with a side rest so ladles don't slip into crocks or serving bowls.
- Made of virtually unbreakable Camwear polycarbonate for years of dependable service.

Colors: Cranberry (416), Black (110), Beige (133), Clear (135), White (148), Reddish Brown (195).

*Cambro's assortment pack offers 8 imprinted ladles and 4 with no imprinting. The 8 imprints include: 1 Thousand Island, 1 French, 1 House, 1 Italian, 1 Bleu Cheese, 1 Ranch, 1 Low Cal, 1 Caesar. This makes a perfect start-up set for a salad bar.

Custom Order Ladle Imprints – See personalization section for information, ordering and pricing. Maximum imprint area is 1" x 1/2". Six dozen minimum.

No broken cartons on assortment pack or imprinted ladles.



**Imprinted Ladles shown.

CODE	DESCRIPTION	LENGTH	CAPACITY	CASE LBS. (CUBE)	LIST PRICE EA.
LD85	Plain	8 $\frac{1}{2}$ "	3/4 oz.	1 (0.09)	\$ 3.15
LD85A*	Assortment	8 $\frac{1}{2}$ "	3/4 oz.	1 (0.09)	4.50
LD105	Plain	10 $\frac{1}{16}$ "	1 oz.	1.25 (0.13)	3.15
LD105A*	Assortment	10 $\frac{1}{16}$ "	1 oz.	1.25 (0.13)	4.50
LD130	Plain	13"	1 oz.	1.25 (0.11)	3.50
LD130A*	Assortment	13"	1 oz.	1.25 (0.11)	4.75

Case Pack: 12

InStock Color: Black (110).

SERVING SPOONS, CAMTENSILS® & TURNERS

Camwear® Serving Spoons

- Made of virtually unbreakable polycarbonate, Camwear spoons won't tarnish, bend or dent.
- A wide handle and molded in thumb rest ensures a solid, ergonomic grip.
- Spoons feature a notched back to rest on pans.

Colors: Black (110), Beige (133), Clear (135), White (148) Red (404).



Camwear Polycarbonate Serving Spoons



CODE	SPOP10CW	SPOP11CW	SPOP13CW
DESCRIPTION	¾ oz. 10" Perforated Salad Spoon	11" Perforated Deli Spoon	13" Perforated Deli Spoon
DIMENSIONS	10¼" x 1½"	11⅞" x 2⅞"	13⅞" x 2⅞"
CASE LBS. (CUBE)	0.65 (0.04)	1 (0.01)	2.22 (0.25)
LIST PRICE EACH	\$ 2.65	\$ 3.25	\$ 5.55

Case Pack: 12

Camwear Solid Serving Spoons



CODE	SP08CW	SP010CW	SP011CW	SP013CW
DESCRIPTION	¼ oz. 8" Salad Spoon	¾ oz. 10" Buffet Spoon	11" Deli Spoon	13" Deli Spoon
DIMENSIONS	8⅞" x 1½"	10¼" x 1½"	11⅞" x 2⅞"	13⅞" x 2⅞"
CASE LBS. (CUBE)	0.54 (0.03)	0.67 (0.04)	1.50 (0.09)	2.22 (0.26)
LIST PRICE EACH	\$ 2.40	\$ 2.65	\$ 3.25	\$ 5.55

InStock Colors: Black (110).



High Heat Camtensils, Spoons and Turners

- Ideal for preparing and serving hot and cold foods.
- Made of a durable high heat material that withstands temperatures from -40°F to 375°F (-40°C to 190°C).
- Handle includes a hole for hanging when not in use and notches to rest on pans.

Color: Amber (150), Black (110).

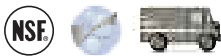

High Heat Solid Spoons & Turners



CODE	SP011	SP013	SPA14
DESCRIPTION	11" Deli Spoon	13" Solid Spoon	14" Solid Turner
DIMENSIONS	11⅞" x 2⅞"	13⅞" x 2⅞"	14⅞" x 3½"
CASE LBS. (CUBE)	1.98 (0.1)	2.35 (0.25)	7 (0.65)
LIST PRICE EACH	\$ 5.05	\$ 8.30	\$ 9.35

Case Pack: 12

High Heat Perforated Spoons & Slotted Turners



CODE	SPOP11	SPOP13	SPASL14
DESCRIPTION	11" Perforated Spoon	13" Perforated Spoon	14" Slotted Turner
DIMENSIONS	11⅞" x 2⅞"	13⅞" x 2⅞"	14⅞" x 3½"
CASE LBS. (CUBE)	1.50 (0.09)	2.35 (0.26)	3.6 (0.3)
LIST PRICE EACH	\$ 5.05	\$ 8.30	\$ 9.35

Case Pack: 12

High Heat Spoons and Turners now available in Black.



LUGANO™ TONGS

- Colored tongs are made from a durable heat resistant material that withstands temperatures up to 300°F (149°C).
- Ideal for serving cold and hot food, even from steam tables.
- Clear tongs are made from virtually unbreakable polycarbonate, which is safe to 210°F (99°C).

56

Lugano Flat and Scallop Grip Tongs

- Easily grasp hard to hold items such as salad greens and tomatoes.
- Scallop Tongs feature an ergonomic design and secure finger grip.
- Flat Tongs are ribbed to provide a secure hold.

Colors: Black (110), Beige (133), *Clear (135), **Red (404), White (148).

Two year warranty on colored tongs.
* Clear is safe to 210°F (99°C)
** Red is NSF to 210°F (99°C)



Lugano Angled and Easy-Grasp Tongs

- Angled tongs feature an ergonomic design that makes it easy to serve a variety of foods.
- Easy-Grasp Tongs combine a fork and spoon, providing a secure grip for hard to hold items.

Colors: Black (110), Beige (133), Clear (135), White (148).

Two year warranty on colored tongs.
Angled and Easy-Grasp Lugano Tongs are covered under U.S. Patent D 530,994.
Easy-Grasp Lugano Tongs are not NSF listed.



Flat Grip Tongs



CODE	TG6	TG9	TG12
LENGTH	6"	9"	12"
CASE LBS. (CUBE)	1 (0.05)	1.64 (0.21)	3.50 (0.22)
LIST PRICE EACH	\$ 2.30	\$ 3.65	\$ 5.55

Case Pack: 12

Scallop Grip Tongs



CODE	6TGS	9TGS	12TGS
LENGTH	6"	9"	12"
CASE LBS. (CUBE)	0.81 (0.07)	1.85 (0.16)	2.5 (0.22)
LIST PRICE EACH	\$ 2.35	\$ 3.65	\$ 5.55

Case Pack: 12

InStock Color: Black (110).

Angled Tongs



CODE	TGA8	TGA11
DESCRIPTION	Angled Tong	Angled Tong
DIMENSIONS	8 1/4"	10 1/8"
CASE LBS. (CUBE)	2.2 (0.19)	2.86 (0.24)
LIST PRICE EACH	\$ 3.75	\$ 4.35

Case Pack: 12

InStock Color: Black (110).

Easy-Grasp Tongs



CODE	TGG6	TGG9
DESCRIPTION	Easy-Grasp Tong	Easy-Grasp Tong
DIMENSIONS	6"	9 1/2"
CASE LBS. (CUBE)	1.39 (0.16)	2.25 (0.25)
LIST PRICE EACH	\$ 3.75	\$ 4.05

Case Pack: 12

InStock Color: Black (110).

CAMWEAR® POLYCARBONATE SHAKERS/DREDGES & CONDIMENT JARS

Camwear Shakers/Dredges

- A staple in the kitchen, at the condiment station or on the dining table.
- Clear virtually unbreakable Camwear® polycarbonate and color coded lids make it easy to identify contents.
- Dishwasher safe and unaffected by food acids.

Shaker Color: Clear (135).



96SKRLF
Fine Ground



96SKRLD
Salt & Pepper



96SKRLM
Med. Ground



96SKRLN
Solid



96SKRLC
Cheese



96SKRLP
Parsley

CODE	COLOR	APPROX. CAPACITY	CASE LBS. (CUBE)	LIST PRICE EA.
------	-------	------------------	------------------	----------------

Shakers complete with lids

96SKRF (w/fine ground lid)	—	10 oz.	3.09 (0.30)	\$ 5.40
96SKRP (w/parsley lid)	—	10 oz.	3.09 (0.30)	5.40
96SKRD (w/salt & pepper lid)	—	10 oz.	3.09 (0.30)	5.40
96SKRC (w/cheese lid)	—	10 oz.	3.09 (0.30)	5.40
96SKRN (w/solid lid)	—	10 oz.	3.09 (0.30)	5.40
96SKRM (w/medium ground lid)	—	10 oz.	3.10 (0.30)	5.40

Replacement Lids

96SKRLF fine ground lid	Green (407)	—	0.24 (0.09)	0.95
96SKRLP parsley lid (Bulk pack available)	White (148)	—	1.12 (0.01)	0.95
96SKRLD salt & pepper lid	Beige (406)	—	0.28 (0.05)	0.95
96SKRLC cheese lid	Yellow (405)	—	0.26 (0.05)	0.95
96SKRLN solid lid	White (148)	—	0.6 (0.09)	0.95
96SKRLM medium ground lid	Rose (408)	—	0.26 (0.07)	0.95

Case Pack: 12

InStock Color: Clear (135).

Camwear Condiment Jars

- Use to hold condiments such as mustard, ketchup, dressings, jam or salsa.
- Made of clear, virtually unbreakable Camwear polycarbonate.
- Lids are slotted to hold serving spoons when not in use.

Color: Clear (135).



CODE	APPROXIMATE CAPACITY	SIZE H x D	CASE PACK	CASE LBS. (CUBE)	LIST PRICE EA.
------	----------------------	------------	-----------	------------------	----------------

Jar & Cover

CJ80CW	8 oz.	4" x 3 3/4"	24	0.8 (0.23)	\$ 7.65
--------	-------	-------------	----	------------	---------

*Spoons not included

STORAGE

- Camshelving®
- Security Cage for Camshelving
- Camshelving Dome Drying & Storage Cart
- Wall Shelves
- Shelf Extenders
- Dunnage Racks
- Pizza Dough Boxes
- StoreSafe® Food Rotation Labels
- Quick Guide to Storage Solutions
- CamSquare® Storage Containers
- Round Storage Containers
- Food Storage Boxes & Lids
- Food Pans at A Glance
- Camwear® Food Pans & Lids
- H-Pans™ & Lids
- ColdFest®
- Translucent Food Pans & Lids
- Ingredient Bins
- Camcrisper®
- Camwear Scoops
- Camwear Measuring Cups



CAMSHELVING®



- ▶ **Easy and Quick to Clean**
- ▶ **Easy to Adjust and Configure**
- ▶ **Unquestionably Strong, Durable and Stable**
- ▶ **Rust Free**



CAMSHELVING COMPONENTS ARE:



Store and Transport
Food Safely



COMPONENTS

Listed by the National Sanitation Foundation. NSF, an independent testing organization, lists products which meet their criteria for sanitation and cleanability



Dishwasher Safe
Except mobile parts



Fit for Food
Products



Cadmium-Free



Recyclable
Polypropylene

CAMBRO

EQUIPMENT

DESIGNED FOR DURABILITY

Consultant Cut Sheets and CAD drawings are available on www.cambro.com, KCL or AutoQuotes

Camshelving is covered by EU Patent #0686817.

EASY AND QUICK TO CLEAN



For a Sanitary Storage Area

- Shelf plates are easy to remove and run through the dishwasher.
- Smooth polypropylene surface quickly wipes clean.
- Spills clean quickly and easily, reducing the risk of cross-contamination.
- Camshelving® is weldless, so liquids and dirt cannot get inside crevices.

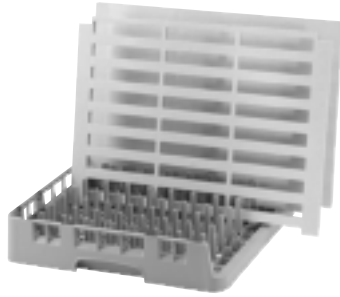

Shelf plates can be placed in an open end Camrack® OETR314 and washed in a commercial dishwasher.

- A silver-ion technology that inhibits the growth of mold, fungus and bacteria.
- Camguard works continuously to suppress the growth of microbes between cleanings.
- All shelf plates are embedded with Camguard antimicrobial so it will not scrape off, wash off or wear out.



STRONG AND DURABLE

Strong as Steel

- Posts and traverses are the weight bearing components, constructed with a steel core and encapsulated by a thick polypropylene outer layer.

- Inner steel core ensures that Camshelving is strong, durable and stable.
- Thick, polypropylene outer layer will not chip, break or corrode.
- Post connectors provide exceptional cross stabilization.

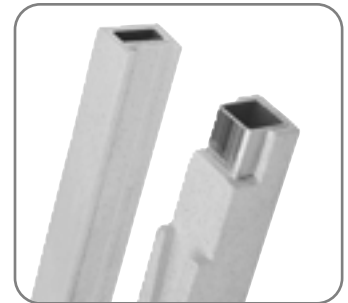

Weight bearing components are made with a steel core.

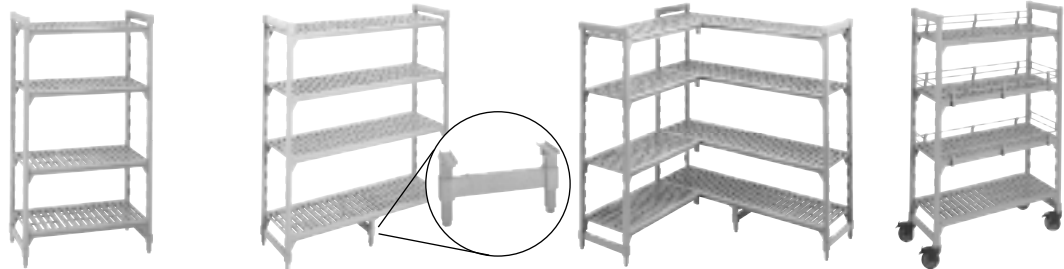

	Single Unit - 4 Shelves	Single Unit - 4 Shelves	Dunnage Stand	Corner Unit (Attached Unit)	Mobile Unit
TRAVERSE LENGTH	24" to 48" (610 mm to 1220 mm)	54" to 72" (1380 mm to 1830 mm)	54" to 72" (1380 mm to 1830 mm)	24" to 48" (610 mm to 1220 mm)	24" to 48" (610 mm to 1220 mm)
WEIGHT BEARING CAPACITY PER SHELF	800 lbs. (363 Kg)	600 lbs. (272 Kg)	1000 lbs. (454 Kg)	400 lbs. (181 Kg)	—
WEIGHT BEARING CAPACITY PER UNIT	3200 lbs. (1451 Kg)	2400 lbs. (1089 Kg)	—	1600 lbs. (726 Kg)	750 lbs. (340 Kg)

Dunnage Stands are used only on the bottom shelf. Recommended for traverses 54" (1380 mm) or longer.

Corner Connectors are recommended for use on traverses 48" (1220 mm) or less.

Due to the weight bearing capacity of casters, maximum weight load on an entire Mobile Camshelving Unit is 750 lbs. (340 Kg).

EASY TO ASSEMBLE & ADJUST

Build Any Configuration and Fit Any Size Area

- Create a space efficient layout for any area.
- Assembles in minutes, requiring only the use of a mallet.
- Shelves can be adjusted in 4" (100 mm) increments without disassembling the entire unit.
- Two units can be connected together with shelves at alternating heights for maximum storage flexibility.
- Corner Connectors attach units to create a 90° angle or U shape.

POST HEIGHT	DOVETAIL INCREMENT	NUMBER OF POSITIONS PER POST
Stationary		
32" (820 mm)	4" (100 mm)	6
56" (1430 mm)	4" (100 mm)	12
64" (1630 mm)	4" (100 mm)	14
72" (1830 mm)	4" (100 mm)	16
84" (2140 mm)	4" (100 mm)	19
Mobile		
35" (890 mm)	4" (100 mm)	6
59" (1500 mm)	4" (100 mm)	12
67" (1700 mm)	4" (100 mm)	14
75" (1910 mm)	4" (100 mm)	16

EASY TO ADJUST!

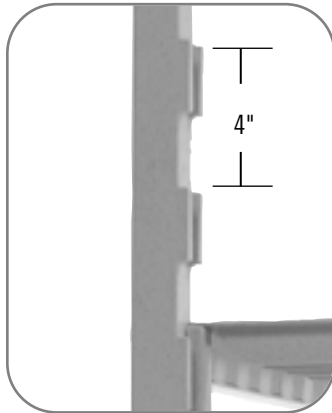

Shelves can be adjusted in 4" (100 mm) increments, without disassembling the unit.

EASY TO ASSEMBLE!

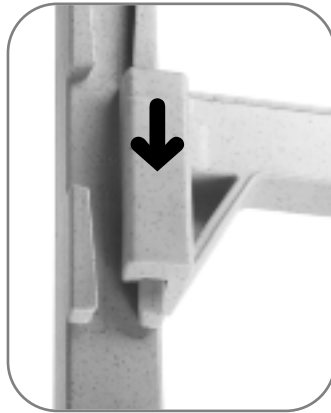

Traverses slide easily down onto dovetail.

RUST FREE

For Use in Any Area, Wet or Dry

- Camshelving is weldless with no exposed metal, so it remains rust free.
- Safe to -36°F (-38°C), making Camshelving the ideal shelving system for freezers, walk-ins or any wet or humid environment.
- Not even salt water or sea air will corrode Camshelving.



Lifetime limited warranty against rust and corrosion for traverses and stationary posts.



Dry Storage Room



Cold Storage Room

FREE CAMSHELIVING® CONSULTING



Cambro provides a free consulting service to maximize your storage area. No cost or obligation.

1. Simply provide the dimensions of the storage space, number of shelves per unit, height of the posts, and any additional requirements you have.

2. Cambro will provide a recommended floor plan and product order list.
3. Your Cambro distributor or sales representative will contact you with pricing.

4. To contact the Camshelving Consulting Department, please call 1-714-230-4113, Fax 1-714-230-4199 or email mperez@cambro.com.

COMPONENTS

Camshelving® is a modular system that allows the flexibility to assemble shelving to fit any size area. The key components, including posts, post connectors, traverses and shelf plates, are available in a variety of

sizes. They can be easily configured to custom build shelving to maximize storage space. Unique design elements such as shared posts and corner connectors simplify assembly and increase storage capacity.

TRAVERSES

Traverses have a steel core with a polypropylene exterior to provide strength and durability.

Traverses connect to the post by sliding on to the dovetail on the post.

Two traverses are needed to build one shelf, and they define the length of the unit.

SHELF PLATES

Shelf Plates are made of polypropylene. Dishwasher safe.

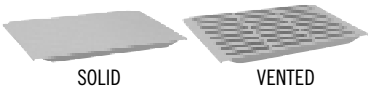

SOLID

VENTED

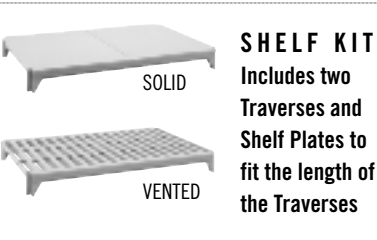

SHELF KIT
Includes two Traverses and Shelf Plates to fit the length of the Traverses

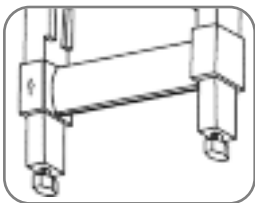

POSTS FOR STATIONARY UNIT

Posts have a steel core with a polypropylene exterior to provide strength and durability.

Posts define the height of the shelving unit and are measured with the leveling foot fully engaged.



Post for Stationary Unit

STATIONARY UNIT

POST CONNECTORS

Post connectors hold two posts together and define the width of the unit.

They are made of polypropylene and provide excellent cross stabilization.



TOP

BOTTOM

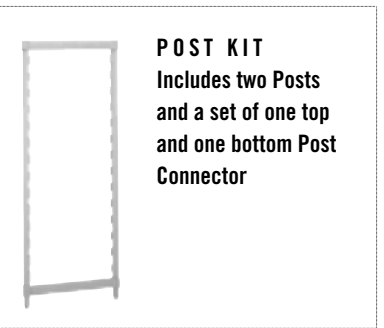

POST KIT
Includes two Posts and a set of one top and one bottom Post Connector

POSTS FOR MOBILE CAMSHELVING

Mobile Camshelving posts must be used to build mobile Camshelving units.



Post for Mobile Unit

MOBILE UNIT

CASTERS

Available in standard for dry storage or premium for freezers, cold, or wet applications.



MAXIMIZE SPACE UTILIZATION

Camshelving® is available in starter and add-on units for ease of ordering and assembly.

Starter Units

- Available in stationary or mobile units.
- Starter units ship complete with two post kits, traverses and shelf plates to build an entire unit.

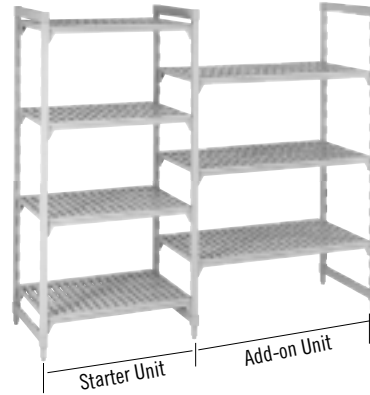

Add-On Units

- Add-On units ship complete with one post kit, traverses and shelf plates to attach to an adjoining unit.
- The traverses on both the first and second unit share the middle post.
- No add-on clips or S-hooks required.
- There is no loss of weight bearing capacity when built in a straight line.

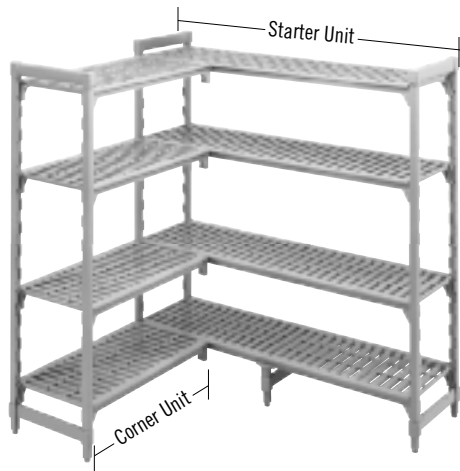

Corner Unit & U Shape Units

- Corner connectors can be used to build corner units and U Shape units.
- Traverses snap onto corner connectors just like they snap onto the dovetails of the posts.

Corner Connector Set

- Attaches a basic unit to a second unit at a 90° angle or to form a U shape.
- A set of corner connectors are needed for each shelf.



* Corner connectors are recommended for use on traverses equal to or shorter than 48" (1220 mm), and covered by U.S. Patent D498,664S.

Dunnage Stand

- Increases weight bearing capacity to 1000 lbs. (454 kg) on the bottom shelf.
- Recommended for units 54" (1380 mm) or longer.

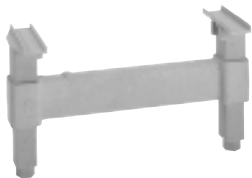

* Dunnage stands are covered by U.S. Patent US 6,981,454B2.

Fence System

- Prevents stored items from falling off shelving units.
- Ideal for mobile shelving.

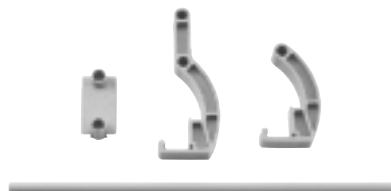

Mobile Units

- Mobile Camshelving units are built by using posts for mobile carts and inserting casters.
- Mobile units are not designed to serve as transport carts.
- Casters sold separately.



Mobile unit shown with optional fencing.

Seismic Foot

- Bolts a post to the floor for a more stable base.
- Screws not included.



Wall Fastener

- Fastens a unit to a wall as a safety precaution.
- Screws not included.



Identification Tag

- Easily clips onto traverses to identify stored items.
- Made of PVC.
- Includes 12 HACCP labels.



Donut Bumper

- Protects mobile Camshelving.
- 3/2" (90 mm) Bumper.

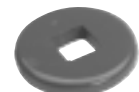

CAMSHELVING® HIGH DENSITY STORAGE SYSTEM

High Density Camshelving is easy to assemble and configure. Camshelving stationary units act as the system anchor. Mobile units with vented shelves, exclusive high density casters, and track kits complete the system.

Maximize Storage Capacity

- High Density system utilizes all available space by eliminating aisles.
- Increases storage capacity by 30%-40%. Ideal for operations with limited storage space.

Easy to Clean

- Units can be cleaned without disassembling the entire unit.
- Shelf plates can be easily removed and run through the dishwasher.
- Raised track ensures dirt will not get trapped, and is easy to clean.

Easy to Order and Assemble:

1. Determine your room size and needs.
2. Choose starter unit size (pg. 70). Starter unit width must be 24". Existing Camshelving stationary units can be retrofitted and utilized as the anchors.
3. Choose High Density Mobile Units size (see chart below).
4. Determine number of track kits needed based on room length.

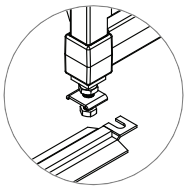
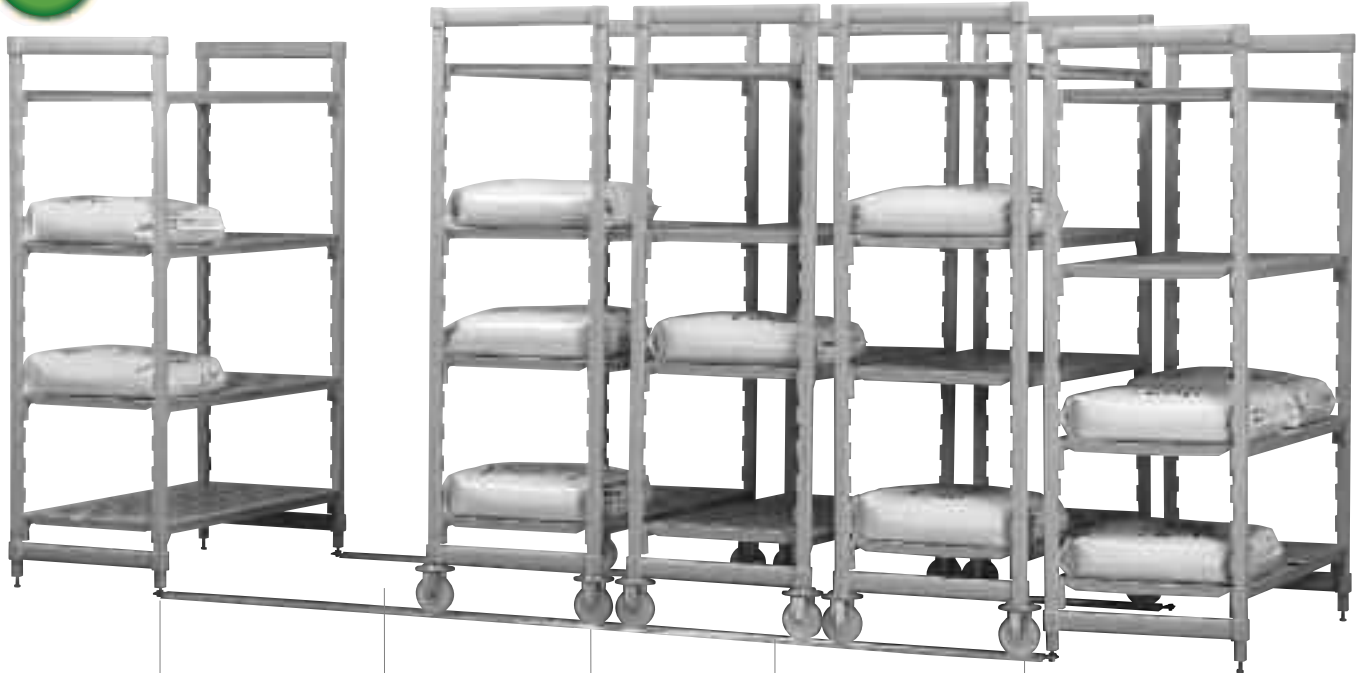

The track simply connects to the bottom of the Stationary Camshelving Unit. It is not necessary to drill into the floor to bolt the track down.

Active aisle of 36" provides easy access to all stored product.

Rail tracks provide a smooth and level surface to easily roll mobile units. Ideal for use on choppy or uneven floors.

Mobile units are positioned between two stationary units.

Grooved casters roll easily and securely on track. Donut bumpers protect casters against damage.

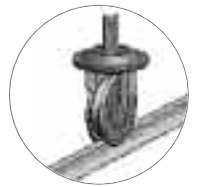

*High Density Mobile Units include 4 High Density Casters. **Weight bearing capacity of High Density Mobile Camshelving Units is 750 lbs. (340 kg). ***It is recommended to use Fencing with High Density Camshelving. Refer to page 74 for product details.

All necessary hardware is included in the track kit.

CODE	DESCRIPTION	SIZE	CASE PACK	CASE LBS. (CUBE)	LIST PRICE
Track Kits					
CSHDTK10	10' Track Kit for 3 Mobile Units	120"	1	21.81 (0.336)	\$ 620.00
CSHDTK12	12' Track Kit for 4 Mobile Units	144"	1	25.61 (0.398)	715.00
CSHDTK145	14.5' Track Kit for 5 Mobile Units	174"	1	30.13 (0.458)	805.00
High Density Vented Mobile Starter Units					
CSUHD44486	Mobile Unit 4 Shelves	24" x 48" x 67"	1	113.00 (8.01)	1,054.60
CSUHD44487	Mobile Unit 4 Shelves	24" x 48" x 75"	1	108.00 (8.16)	1,059.40
CSUHD44427	Mobile Unit 4 Shelves	24" x 42" x 75"	1	107.74 (8.01)	1,016.40
CSUHD44367	Mobile Unit 4 Shelves	24" x 36" x 75"	1	98.94 (8.01)	951.20
CSHDDB	High Density Donut Bumper		4	2.05 (0.048)	10.70

Color: Speckled Gray (480) Track Kits Color: (000)

CAMSHELVING® CONFIGURATION DETAILS

- The following charts are provided to assist in developing a footprint for your storage area.
- They can also be used to help determine your actual shelf space.
- Traverse measurements are based on outside, or overall unit length.
- This includes the posts.
- The overall length varies slightly when using a basic unit, add-on unit, intermediate unit or corner unit.
- These variations are outlined below.

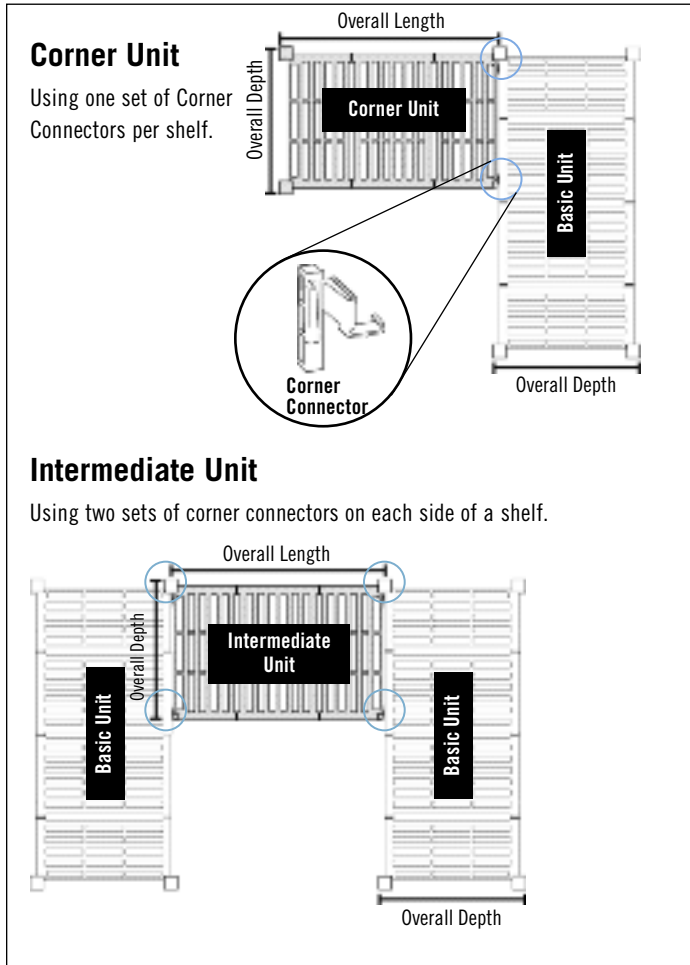
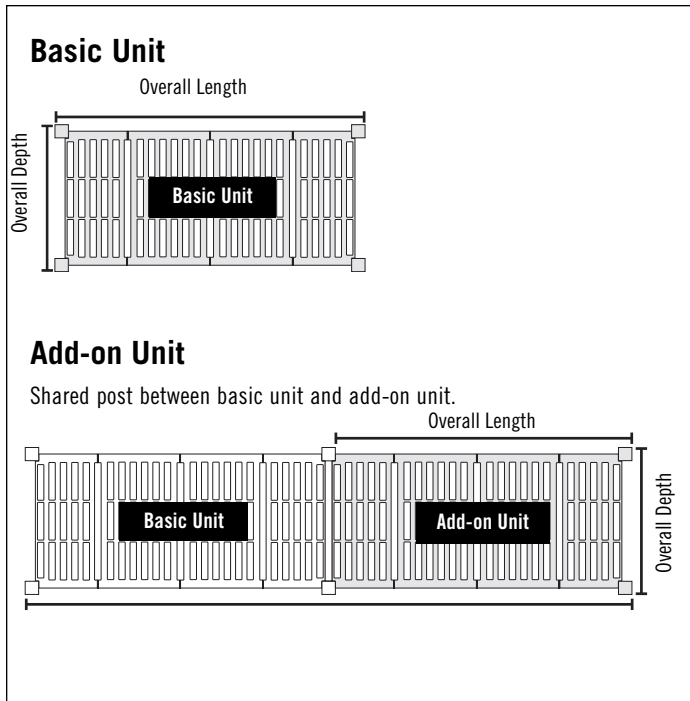

UNIT	BASIC UNIT OVERALL LENGTH	ADD-ON UNIT OVERALL LENGTH	BASIC + ADD-ON UNIT OVERALL LENGTH
24" (610 mm)	24" (610 mm)	22¼" (565 mm)	46¼" (1175 mm)
30" (760 mm)	30" (760 mm)	28¼" (720 mm)	58¼" (1480 mm)
36" (910 mm)	36" (910 mm)	34¼" (870 mm)	70¼" (1780 mm)
42" (1070 mm)	42" (1070 mm)	40¼" (1025 mm)	82¼" (2095 mm)
48" (1220 mm)	48" (1220 mm)	46¼" (1175 mm)	94¼" (2395 mm)
54" (1380 mm)	54" (1380 mm)	52¼" (1330 mm)	106¼" (2710 mm)
60" (1530 mm)	60" (1530 mm)	58¼" (1480 mm)	118¼" (3010 mm)
72" (1830 mm)	72" (1830 mm)	70¼" (1790 mm)	142¼" (3620 mm)





UNIT	CORNER UNIT OVERALL LENGTH	INTERMEDIATE UNIT OVERALL LENGTH
24" (610 mm)	23" (585 mm)	22" (560 mm)
30" (760 mm)	29" (740 mm)	28" (715 mm)
36" (910 mm)	35" (890 mm)	34" (865 mm)
42" (1070 mm)	41" (1045 mm)	40" (1020 mm)
48" (1220 mm)	47" (1195 mm)	46" (1170 mm)
54" (1380 mm)	53" (1350 mm)	52" (1325 mm)
60" (1530 mm)	59" (1500 mm)	58" (1475 mm)
72" (1830 mm)	71" (1805 mm)	70" (1780 mm)

Shelf Spacing





Dovetails are spaced every 4" (100 mm)

POST HEIGHT	NUMBER OF POSITIONS PER POST	POST HEIGHT	NUMBER OF POSITIONS PER POST
Stationary		Mobile	
32" (820 mm)	6	35" (890 mm)	6
56" (1430 mm)	12	59" (1500 mm)	12
64" (1630 mm)	14	67" (1700 mm)	14
72" (1830 mm)	16	75" (1910 mm)	16
84" (2140 mm)	19		





STATIONARY POST KITS AND ACCESSORIES

Stationary Post Kits					
HEIGHT	WIDTH	14" 360 mm	18" 460 mm	21" 540 mm	24" 610 mm
32" 820 mm	CODE	CSPK1432	CSPK1832	CSPK2132	CSPK2432
	CASE LBS. (CUBE)	5 (0.31)	5.39 (0.32)	5.7 (0.31)	6.21 (0.3)
	CASE KG (CUBE M ³)	3,83 (0,0091)	3,99 (0,0091)	4,13 (0,0091)	4,31 (0,0091)
	LIST PRICE KIT	\$ 60.25	\$ 64.45	\$ 66.85	\$ 67.65
56" 1430 mm	CODE	CSPK1456	CSPK1856	CSPK2156	CSPK2456
	CASE LBS. (CUBE)	13.45 (0.41)	13.80 (0.41)	14.10 (0.41)	14.50 (0.41)
	CASE KG (CUBE M ³)	6,10 (0,0116)	6,26 (0,0116)	6,40 (0,0116)	6,58 (0,0116)
	LIST PRICE KIT	\$ 82.30	\$ 86.50	\$ 88.95	\$ 89.70
64" 1630 mm	CODE	CSPK1464	CSPK1864	CSPK2164	CSPK2464
	CASE LBS. (CUBE)	15.45 (0.46)	15.2 (0.42)	15.83 (0.46)	16.50 (0.46)
	CASE KG (CUBE M ³)	7,0 (0,0130)	7,17 (0,0130)	7,30 (0,0130)	7,48 (0,0130)
	LIST PRICE KIT	\$ 89.80	\$ 94.00	\$ 96.40	\$ 97.15
72" 1830 mm	CODE	CSPK1472	CSPK1872	CSPK2172	CSPK2472
	CASE LBS. (CUBE)	17.20 (0.52)	17.05 (0.46)	17.2 (0.52)	18.25 (0.52)
	CASE KG (CUBE M ³)	7,80 (0,0147)	7,96 (0,0147)	8,10 (0,0147)	8,28 (0,0147)
	LIST PRICE KIT	\$ 91.90	\$ 96.10	\$ 98.40	\$ 99.30
84" 2140 mm	CODE	CSPK1484	CSPK1884	CSPK2184	CSPK2484
	CASE LBS. (CUBE)	19.95 (0.61)	18.89 (0.57)	19.2 (0.54)	19.71 (0.54)
	CASE KG (CUBE M ³)	9,05 (0,0173)	9,21 (0,0173)	9,34 (0,0173)	9,52 (0,0173)
	LIST PRICE KIT	\$ 106.75	\$ 111.05	\$ 113.30	\$ 114.20









Case Pack: 1. Color: Speckled Gray (480).

Dunnage Stands					
HEIGHT	WIDTH	14" 360 mm	18" 460 mm	21" 540 mm	24" 610 mm
6½" 165 mm	CODE	CSDS14	CSDS18	CSDS21	CSDS24
	CASE LBS. (CUBE)	2.60 (0.18)	2.90 (0.22)	3.10 (0.26)	3.30 (0.30)
	CASE KG (CUBE M ³)	1,20 (0,0050)	1,30 (0,0062)	1,40 (0,0074)	1,50 (0,0085)
	LIST PRICE KIT	\$ 60.05	\$ 62.00	\$ 63.60	\$ 65.20

Case Pack: 1. Color: Speckled Gray (480).









Accessories						
		Seismic Foot	Wall Fastener	Corner Connectors	Id Tag 6"	Id Tag 3"
	CODE	CSEQ3	CSWF	CSCC	CSID	CSID3
	DESCRIPTION	Seismic Foot	Wall Fastener	90° Left & Right	6" ID Tag	3" ID Tag
	COLOR	Silver	Silver	Speckled Gray (480)	White/Clear	White/Clear
	SIZE L x W x H	4" x 3¼" x 2⅝" (100 x 85 x 60 mm)	17" x 1⅞" x 1⅝" (432 x 48 x 40 mm)	—	1" x 6" (25 x 150 mm)	1" x 3" (25 x 80 mm)
	CASE LBS. (CUBE)	1.43 (0.04)	5 (0.21)	0.38 (0.05)	0.82 (0.08)	0.58 (0.06)
	CASE KG (CUBE M ³)	0,017 (0,011)	8,65 (0,0034)	0,017 (0,014)	0,35 (0,0079)	0,35 (0,0079)
	CASE PACK	4 each	4 each	1 set of 2 parts	12 each	12 each
	LIST PRICE EA.	\$ 33.00	\$ 25.00	\$ 5.40 each set	\$ 2.25	\$ 2.25

SOLID SHELF KITS

									
WIDTH	LENGTH	24"	30"	36"	42"	48"	54"	60"	72"
		610 mm	760 mm	910 mm	1070 mm	1220 mm	1380 mm	1530 mm	1830 mm
14"	CODE	CS1424SK	CS1430SK	CS1436SK	CS1442SK	CS1448SK	CS1454SK	CS1460SK	CS1472SK
	CASE LBS. (CUBE)	7.79 (0.83)	9.62 (0.83)	11.45 (0.83)	13.29 (0.97)	15.11 (1.06)	16.38 (1.63)	18.29 (1.38)	22.20 (1.66)
	CASE KG (CUBE M³)	3.53 (0,0235)	4.36 (0,0235)	5.19 (0,0235)	6.03 (0,0274)	6.85 (0,0300)	7.68 (0,035)	18.30 (0,0390)	10.07 (0,0470)
	360 mm LIST PRICE KIT	\$ 56.70	\$ 70.40	\$ 78.25	\$ 90.10	\$ 99.35	\$ 111.10	\$ 119.85	\$ 140.60
18"	CODE	CS1824SK	CS1830SK	CS1836SK	CS1842SK	CS1848SK	CS1854SK	CS1860SK	CS1872SK
	CASE LBS. (CUBE)	7.4 (0.87)	9.3 (0.87)	12.06 (0.83)	14.40 (0.97)	15.78 (1.06)	18.12 (1.24)	19.95 (1.38)	23.91 (1.66)
	CASE KG (CUBE M³)	3.78 (0,0235)	4.63 (0,0235)	5.47 (0,0235)	6.53 (0,0274)	7.16 (0,0300)	8.22 (0,0351)	9.05 (0,0390)	10.84 (0,0470)
	460 mm LIST PRICE KIT	\$ 59.50	\$ 73.20	\$ 81.45	\$ 97.45	\$ 102.70	\$ 118.80	\$ 130.10	\$ 151.00
21"	CODE	CS2124SK	CS2130SK	CS2136SK	CS2142SK	CS2148SK	CS2154SK	CS2160SK	CS2172SK
	CASE LBS. (CUBE)	9.14 (0.83)	11.28 (0.83)	11.82 (1.32)	14.65 (1.61)	17.71 (1.06)	18.62 (1.7)	20.57 (1.89)	24.57 (2.3)
	CASE KG (CUBE M³)	4.14 (0,0235)	5.12 (0,0235)	6.09 (0,0235)	7.33 (0,0274)	8.03 (0,0300)	9.28 (0,0351)	10.27 (0,039)	12.33 (0,0470)
	540 mm LIST PRICE KIT	\$ 66.20	\$ 82.85	\$ 92.60	\$ 110.00	\$ 118.40	\$ 135.75	\$ 147.80	\$ 173.20
24"	CODE	CS2424SK	CS2430SK	CS2436SK	CS2442SK	CS2448SK	CS2454SK	CS2460SK	CS2472SK
	CASE LBS. (CUBE)	9.27 (0.83)	11.61 (0.83)	13.95 (0.83)	15.7 (1.63)	17.38 (1.32)	21.08 (1.24)	22.96 (1.38)	27.89 (1.66)
	CASE KG (CUBE M³)	4.20 (0,0235)	5.27 (0,0235)	6.33 (0,0235)	7.44 (0,0274)	8.45 (0,0300)	9.56 (0,0351)	10.41 (0,039)	12.65 (0,0470)
	610 mm LIST PRICE KIT	\$ 70.45	\$ 87.00	\$ 97.70	\$ 113.15	\$ 123.95	\$ 139.55	\$ 151.30	\$ 177.40





Case Pack: 1. Color: Speckled Gray (480).

VENTED SHELF KITS

									
WIDTH	LENGTH	24"	30"	36"	42"	48"	54"	60"	72"
		610 mm	760 mm	910 mm	1070 mm	1220 mm	1380 mm	1530 mm	1830 mm
14"	CODE	CS1424VK	CS1430VK	CS1436VK	CS1442VK	CS1448VK	CS1454VK	CS1460VK	CS1472VK
	CASE LBS. (CUBE)	6.6 (0.87)	9.16 (0.83)	9.78 (1.3)	11.53 (1.59)	14.35 (1.06)	16.12 (1.24)	16.07 (1.88)	19.62 (2.30)
	CASE KG (CUBE M³)	3.37 (0,0235)	4.15 (0,0235)	4.94 (0,0235)	5.74 (0,0274)	6.51 (0,0300)	7.31 (0,0351)	7.89 (0,0390)	9.57 (0,0470)
	360 mm LIST PRICE KIT	\$ 55.30	\$ 68.80	\$ 76.20	\$ 87.25	\$ 96.65	\$ 107.55	\$ 115.35	\$ 135.50
18"	CODE	CS1824VK	CS1830VK	CS1836VK	CS1842VK	CS1848VK	CS1854VK	CS1860VK	CS1872VK
	CASE LBS. (CUBE)	12.82 (1.60)	5.35 (0.87)	11.44 (0.83)	12.82 (1.60)	14.94 (1.06)	15.78 (1.56)	18.80 (1.38)	21.29 (2.32)
	CASE KG (CUBE M³)	3.60 (0,0235)	4.40 (0,0235)	5.19 (0,0235)	6.18 (0,0274)	6.78 (0,0300)	7.76 (0,0351)	8.53 (0,0390)	10.23 (0,0470)
	460 mm LIST PRICE KIT	\$ 56.75	\$ 70.20	\$ 77.75	\$ 92.80	\$ 98.25	\$ 113.20	\$ 123.50	\$ 143.55
21"	CODE	CS2124VK	CS2130VK	CS2136VK	CS2142VK	CS2148VK	CS2154VK	CS2160VK	CS2172VK
	CASE LBS. (CUBE)	8.66 (0.83)	6.25 (0.88)	11.74 (1.02)	13.98 (1.23)	15.17 (1.35)	19.25 (1.24)	19.74 (1.89)	25.53 (1.66)
	CASE KG (CUBE M³)	3.93 (0,0235)	4.84 (0,0235)	5.75 (0,0235)	6.91 (0,0274)	7.57 (0,0300)	8.73 (0,0351)	9.64 (0,0390)	11.58 (0,0470)
	540 mm LIST PRICE KIT	\$ 63.60	\$ 78.80	\$ 87.85	\$ 104.95	\$ 111.40	\$ 128.50	\$ 140.20	\$ 163.50
24"	CODE	CS2424VK	CS2430VK	CS2436VK	CS2442VK	CS2448VK	CS2454VK	CS2460VK	CS2472VK
	CASE LBS. (CUBE)	8.2 (0.89)	6.75 (0.9)	12.45 (1.31)	15.31 (0.97)	17.50 (1.06)	18.87 (1.68)	21.32 (1.38)	25.96 (1.66)
	CASE KG (CUBE M³)	3.96 (0,0235)	4.95 (0,0235)	5.95 (0,0235)	6.94 (0,0274)	7.94 (0,0300)	8.93 (0,0351)	9.67 (0,0390)	11.77 (0,0470)
	610 mm LIST PRICE KIT	\$ 65.05	\$ 81.00	\$ 91.10	\$ 106.35	\$ 116.40	\$ 130.65	\$ 141.20	\$ 166.25

Case Pack: 1. Color: Speckled Gray (480).

VENTED STARTER UNITS 18" WIDTH





WIDTH 18" 460 mm						
HEIGHT	LENGTH	36" 910 mm	42" 1070 mm	48" 1220 mm	54" 1380 mm	60" 1530 mm
64" 1630 mm	CODE - 4 SHELVES	CSU48366	CSU48426	CSU48486	CSU48546	CSU48606
	CASE LBS. (CUBE)	77.36 (5.32)	86.08 (5.32)	84.4 (5.64)	100.08 (5.32)	87.6 (5.57)
	CASE KG (CUBE M³)	35,09 (0,150)	39,04 (0,150)	41,44 (0,1506)	46,00 (0,1506)	48,44 (0,1506)
	LIST PRICE KIT	\$ 499.05	\$ 559.15	\$ 580.90	\$ 640.75	\$ 681.90
64" 1630 mm	CODE - 5 SHELVES	CSU58366	CSU58426	CSU58486	CSU58546	CSU58606
	CASE LBS. (CUBE)	88.80 (5.32)	99.70 (5.32)	106.30 (5.32)	117.20 (5.32)	113.6 (5.44)
	CASE KG (CUBE M³)	40,28 (0,150)	45,22 (0,150)	48,21 (0,1506)	(0,1506)	56,97 (0,1506)
	LIST PRICE KIT	\$ 576.85	\$ 651.90	\$ 679.15	\$ 753.95	\$ 805.35
72" 1830 mm	CODE - 4 SHELVES	CSU48367	CSU48427	CSU48487	CSU48547	CSU48607
	CASE LBS. (CUBE)	78 (5.65)	82.67 (5.56)	89.33 (5.68)	103.58 (5.32)	100.67 (5.76)
	CASE KG (CUBE M³)	36,04 (0,1506)	40,00 (0,1506)	42,39 (0,1506)	47,00 (0,1506)	49,40 (0,1506)
	LIST PRICE KIT	\$ 503.25	\$ 563.30	\$ 585.10	\$ 644.95	\$ 686.05
72" 1830 mm	CODE - 5 SHELVES	CSU58367	CSU58427	CSU58487	CSU58547	CSU58607
	CASE LBS. (CUBE)	90.90 (5.32)	94.2 (6)	108.40 (5.32)	120.70 (5.32)	117 (5.84)
	CASE KG (CUBE M³)	41,23 (0,150)	46,17 (0,150)	49,17 (0,1506)	55,00 (0,1506)	57,92 (0,1506)
	LIST PRICE KIT	\$ 581.00	\$ 656.10	\$ 683.30	\$ 758.10	\$ 809.55

Case Pack: 1.

Color/InStock Color: Speckled Gray (480).

Dimensions provided with line drawings above are actual dimensions.

VENTED ADD-ON UNITS





WIDTH 18" 460 mm						
HEIGHT	LENGTH	36" 910 mm	42" 1070 mm	48" 1220 mm	54" 1380 mm	60" 1530 mm
64" 1630 mm	CODE - 4 SHELVES	CSA48366	CSA48426	CSA48486	CSA48546	CSA48606
	CASE LBS. (CUBE)	61.56 (5.32)	70.28 (5.32)	75.56 (5.32)	84.28 (5.32)	91.00 (5.32)
	CASE KG (CUBE M³)	27,92 (0,1506)	31,88 (0,1506)	34,27 (0,1506)	38,50 (0,1506)	41,28 (0,1506)
	LIST PRICE KIT	\$ 405.10	\$ 465.15	\$ 486.90	\$ 546.75	\$ 587.90
64" 1630 mm	CODE - 5 SHELVES	CSA58366	CSA58426	CSA58486	CSA58546	CSA58606
	CASE LBS. (CUBE)	73.00 (5.32)	83.90 (5.32)	83.6 (5.9)	101.40 (5.32)	109.80 (5.32)
	CASE KG (CUBE M³)	33,11 (0,1506)	38,06 (0,1506)	41,05 (0,1506)	46,00 (0,1506)	49,80 (0,1506)
	LIST PRICE KIT	\$ 482.85	\$ 557.90	\$ 585.15	\$ 659.95	\$ 711.35
72" 1830 mm	CODE - 4 SHELVES	CSA48367	CSA48427	CSA48487	CSA48547	CSA48607
	CASE LBS. (CUBE)	61.91 (5.32)	70.63 (5.32)	75.91 (5.32)	86.03 (5.32)	91.35 (5.32)
	CASE KG (CUBE M³)	28,08 (0,1506)	32,04 (0,1506)	34,43 (0,1506)	39,00 (0,1506)	41,44 (0,1506)
	LIST PRICE KIT	\$ 407.15	\$ 467.25	\$ 489.00	\$ 548.85	\$ 590.00
72" 1830 mm	CODE - 5 SHELVES	CSA58367	CSA58427	CSA58487	CSA58547	CSA58607
	CASE LBS. (CUBE)	73.35 (5.32)	84.25 (5.32)	90.85 (5.32)	103.15 (5.32)	100.4 (5.92)
	CASE KG (CUBE M³)	33,27 (0,1506)	38,21 (0,1506)	41,21 (0,1506)	47,00 (0,1506)	49,96 (0,1506)
	LIST PRICE KIT	\$ 484.95	\$ 560.00	\$ 587.25	\$ 662.05	\$ 713.45

Case Pack: 1.

Color: Speckled Gray (480).

Dimensions provided with line drawings above are actual dimensions.

VENTED STARTER UNITS 21" WIDTH





WIDTH 21" 540 mm						
HEIGHT	LENGTH	36"	42"	48"	54"	60"
		910 mm	1070 mm	1220 mm	1380 mm	1530 mm
64" 1630 mm	CODE - 4 SHELVES	CSU41366	CSU41426	CSU41486	CSU41546	CSU41606
	CASE LBS. (CUBE)	82.92 (7.30)	93.12 (7.30)	92 (7.25)	109.20 (7.30)	105.4 (7.23)
	CASE KG (CUBE M ³)	37,61 (0,200)	42,24 (0,200)	44,89 (0,2007)	49,53 (0,2007)	53,18 (0,2007)
	LIST PRICE KIT	\$ 544.15	\$ 612.60	\$ 638.35	\$ 706.75	\$ 753.60
64" 1630 mm	CODE - 5 SHELVES	CSU51366	CSU51426	CSU51486	CSU51546	CSU51606
	CASE LBS. (CUBE)	88.8 (7.04)	97.8 (7.17)	105 (7.18)	115.6 (7.17)	138.50 (7.30)
	CASE KG (CUBE M ³)	43,36 (0,200)	49,15 (0,200)	52,46 (0,2007)	58,26 (0,2007)	62,82 (0,2007)
	LIST PRICE KIT	\$ 632.00	\$ 717.55	\$ 749.70	\$ 835.25	\$ 893.80
72" 1830 mm	CODE - 4 SHELVES	CSU41367	CSU41427	CSU41487	CSU41547	CSU41607
	CASE LBS. (CUBE)	86.42 (7.30)	96.62 (7.30)	102.46 (7.30)	102.6 (7.27)	102.31 (7.05)
	CASE KG (CUBE M ³)	39,20 (0,200)	43,83 (0,200)	46,48 (0,2007)	51,12 (0,2007)	54,77 (0,2007)
	LIST PRICE KIT	\$ 548.15	\$ 616.55	\$ 642.30	\$ 710.70	\$ 757.55
72" 1830 mm	CODE - 5 SHELVES	CSU51367	CSU51427	CSU51487	CSU51547	CSU51607
	CASE LBS. (CUBE)	92 (7.06)	99.4 (7.39)	119.15 (7.30)	118 (6.9)	126.8 (7.14)
	CASE KG (CUBE M ³)	44,95 (0,200)	50,74 (0,200)	54,05 (0,2007)	59,85 (0,2007)	64,41 (0,2007)
	LIST PRICE KIT	\$ 635.95	\$ 721.50	\$ 753.65	\$ 839.20	\$ 896.65

Case Pack: 1.

Color/InStock Color: Speckled Gray (480).

Dimensions provided with line drawings above are actual dimensions.

VENTED ADD-ON UNITS





WIDTH 21" 540 mm						
HEIGHT	LENGTH	36"	42"	48"	54"	60"
		910 mm	1070 mm	1220 mm	1380 mm	1530 mm
64" 1630 mm	CODE - 4 SHELVES	CSA41366	CSA41426	CSA41486	CSA41546	CSA41606
	CASE LBS. (CUBE)	66.82 (7.30)	77.02 (7.30)	82.86 (7.30)	93.10 (7.30)	101.14 (7.30)
	CASE KG (CUBE M ³)	30,31 (0,2007)	34,94 (0,2007)	37,59 (0,2007)	42,23 (0,2007)	45,88 (0,2007)
	LIST PRICE KIT	\$ 447.75	\$ 516.20	\$ 541.90	\$ 610.35	\$ 657.20
64" 1630 mm	CODE - 5 SHELVES	CSA51366	CSA51426	CSA51486	CSA51546	CSA51606
	CASE LBS. (CUBE)	79.50 (7.30)	92.25 (7.30)	91.8 (7.17)	100.4 (7.17)	110 (7.17)
	CASE KG (CUBE M ³)	36,06 (0,2007)	41,84 (0,2007)	45,16 (0,2007)	50,96 (0,2007)	55,52 (0,2007)
	LIST PRICE KIT	\$ 535.60	\$ 621.10	\$ 653.30	\$ 738.80	\$ 797.40
72" 1830 mm	CODE - 4 SHELVES	CSA41367	CSA41427	CSA41487	CSA41547	CSA41607
	CASE LBS. (CUBE)	68.57 (7.30)	78.77 (7.30)	84.61 (7.30)	94.85 (7.30)	86.86 (7.51)
	CASE KG (CUBE M ³)	31,10 (0,2007)	35,73 (0,2007)	38,38 (0,2007)	43,02 (0,2007)	46,67 (0,2007)
	LIST PRICE KIT	\$ 449.75	\$ 518.15	\$ 543.90	\$ 612.30	\$ 659.20
72" 1830 mm	CODE - 5 SHELVES	CSA51367	CSA51427	CSA51487	CSA51547	CSA51607
	CASE LBS. (CUBE)	81.25 (7.30)	94.00 (7.30)	101.30 (7.30)	114.10 (7.30)	124.15 (7.30)
	CASE KG (CUBE M ³)	36,86 (0,2007)	42,64 (0,2007)	45,95 (0,2007)	51,76 (0,2007)	56,31 (0,2007)
	LIST PRICE KIT	\$ 537.55	\$ 623.10	\$ 655.25	\$ 740.80	\$ 799.35

Case Pack: 1.

Color/InStock Color: Speckled Gray (480).

Dimensions provided with line drawings above are actual dimensions.

VENTED STARTER UNITS 24" WIDTH





WIDTH 24" 610 mm						
HEIGHT	LENGTH	36"	42"	48"	54"	60"
		910 mm	1070 mm	1220 mm	1380 mm	1530 mm
64" 1630 mm	CODE - 4 SHELVES	CSU44366	CSU44426	CSU44486	CSU44546	CSU44606
	CASE LBS. (CUBE)	82.4 (8.35)	94.24 (8.28)	103.00 (8.28)	111.80 (8.28)	112.18 (7.98)
	CASE KG (CUBE M ³)	38,75 (0,200)	42,75 (0,200)	46,72 (0,2007)	51,00 (0,2007)	53,65 (0,2007)
	LIST PRICE KIT	\$ 558.60	\$ 619.75	\$ 659.80	\$ 716.75	\$ 759.00
64" 1630 mm	CODE - 5 SHELVES	CSU54366	CSU54426	CSU54486	CSU54546	CSU54606
	CASE LBS. (CUBE)	98.55 (8.28)	109.55 (8.28)	120.50 (8.28)	131.50 (8.28)	139.60 (8.28)
	CASE KG (CUBE M ³)	44,70 (0,200)	49,69 (0,200)	54,66 (0,2007)	60,00 (0,2007)	63,32 (0,2007)
	LIST PRICE KIT	\$ 649.65	\$ 726.10	\$ 776.15	\$ 847.40	\$ 900.20
72" 1830 mm	CODE - 4 SHELVES	CSU44367	CSU44427	CSU44487	CSU44547	CSU44607
	CASE LBS. (CUBE)	86.00 (8.06)	93.00 (8.20)	101.00 (7.88)	115.30 (8.28)	117.00 (8.28)
	CASE KG (CUBE M ³)	40,34 (0,200)	44,33 (0,200)	48,31 (0,2007)	52,50 (0,2007)	55,24 (0,2007)
	LIST PRICE KIT	\$ 562.85	\$ 624.05	\$ 664.05	\$ 721.05	\$ 763.30
72" 1830 mm	CODE - 5 SHELVES	CSU54367	CSU54427	CSU54487	CSU54547	CSU54607
	CASE LBS. (CUBE)	97.2 (7.99)	113.05 (8.28)	116.50 (8.17)	124.00 (8.28)	135.00 (8.78)
	CASE KG (CUBE M ³)	46,49 (0,200)	51,28 (0,200)	56,25 (0,2007)	62,50 (0,2007)	64,91 (0,2007)
	LIST PRICE KIT	\$ 653.95	\$ 730.40	\$ 780.45	\$ 851.70	\$ 904.50

Case Pack: 1.

Color/InStock Color: Speckled Gray (480).

Dimensions provided with line drawings above are actual dimensions.

VENTED ADD-ON UNITS

WIDTH 24" 610 mm						
HEIGHT	LENGTH	36"	42"	48"	54"	60"
		910 mm	1070 mm	1220 mm	1380 mm	1530 mm
64" 1630 mm	CODE - 4 SHELVES	CSA44366	CSA44426	CSA44486	CSA44546	CSA44606
	CASE LBS. (CUBE)	68.13 (7.27)	77.74 (8.28)	83.85 (8.07)	95.30 (8.28)	101.78 (8.28)
	CASE KG (CUBE M ³)	31,27 (0,2007)	35,26 (0,2007)	39,24 (0,2007)	43,50 (0,2007)	46,17 (0,2007)
	LIST PRICE KIT	\$ 461.45	\$ 522.60	\$ 562.65	\$ 619.65	\$ 661.85
64" 1630 mm	CODE - 5 SHELVES	CSA54366	CSA54426	CSA54486	CSA54546	CSA54606
	CASE LBS. (CUBE)	78.8 (8.07)	93.05 (8.28)	104.00 (8.28)	115.00 (8.28)	132.8 (8.07)
	CASE KG (CUBE M ³)	37,22 (0,2007)	42,21 (0,2007)	47,17 (0,2007)	52,50 (0,2007)	55,84 (0,2007)
	LIST PRICE KIT	\$ 552.55	\$ 629.00	\$ 679.05	\$ 750.25	\$ 803.05
72" 1830 mm	CODE - 4 SHELVES	CSA44367	CSA44427	CSA44487	CSA44547	CSA44607
	CASE LBS. (CUBE)	70.69 (8.28)	79.49 (8.28)	86.67 (8.19)	97.05 (8.28)	100.00 (8.49)
	CASE KG (CUBE M ³)	32,06 (0,2007)	36,06 (0,2007)	40,03 (0,2007)	44,00 (0,2007)	46,96 (0,2007)
	LIST PRICE KIT	\$ 463.60	\$ 524.75	\$ 564.80	\$ 621.80	\$ 664.00
72" 1830 mm	CODE - 5 SHELVES	CSA54367	CSA54427	CSA54487	CSA54547	CSA54607
	CASE LBS. (CUBE)	83.80 (8.28)	94.80 (8.28)	105.75 (8.28)	116.75 (8.28)	124.85 (8.28)
	CASE KG (CUBE M ³)	38,01 (0,2007)	43,0 (0,2007)	47,97 (0,2007)	53,00 (0,2007)	56,63 (0,2007)
	LIST PRICE KIT	\$ 554.70	\$ 631.15	\$ 681.20	\$ 752.40	\$ 805.20

Case Pack: 1.

Color: Speckled Gray (480).

Dimensions provided with line drawings above are actual dimensions.

84" SHELVING

- 84" (2140 mm) Camshelving® provides maximum storage capacity in limited space.
- Ideal for operations with high product turnover and extensive menu offerings.
- Add a dunnage stand for greater stability and weight bearing capability.





DUE TO THE HEAVY WEIGHT OF 84" (2140 MM) SHELVING, STARTER AND ADD-ON UNITS WILL BE SHIPPED IN MULTIPLE CARTONS.

Starter Units will ship in three separate cartons: two cartons containing one post kit each, and one carton containing five sets of shelf kits.

Add-On Units will ship in two separate cartons: one carton containing one post kit and one carton containing five sets of shelf kits.







VENTED STARTER UNITS 24" WIDTH

WIDTH 24" 610 mm						
HEIGHT	LENGTH	36" 910 mm	42" 1070 mm	48" 1220 mm	54" 1380 mm	60" 1530 mm
84"	CODE - 5 SHELVES	CSU54368PKG480	CSU54428PKG480	CSU54488PKG480	CSU54548PKG480	CSU54608PKG480
	POST KIT BOX (2)	1 Post Kit	1 Post Kit	1 Post Kit	1 Post Kit	1 Post Kit
	CASE LBS. (CUBE)	21 (0.61)	21 (0.61)	21 (0.61)	21 (0.61)	21 (0.61)
	CASE KG (CUBE M³)	9,52 (0,0173)	9,52 (0,0173)	9,52 (0,0173)	9,52 (0,0173)	9,52 (0,0173)
	SHELF KIT BOX (1)	Set of 5 Shelf Kits	Set of 5 Shelf Kits	Set of 5 Shelf Kits	Set of 5 Shelf Kits	Set of 5 Shelf Kits
	CASE LBS. (CUBE)	60.6 (6.58)	73 (7.85)	80 (6.81)	91.2 (8.41)	101.6 (9.36)
2140 mm	CASE KG (CUBE M³)	27,49 (0,186)	33,11 (0,222)	36,29 (0,193)	41,37 (0,238)	46,08 (0,265)
	LIST PRICE KIT	\$ 683.75	\$ 760.20	\$ 810.25	\$ 881.50	\$ 934.30

Case Pack: Three cartons per unit.
Shipping weight listed above is per carton.

Color: Speckled Gray (480). Dimensions provided with line drawings above are actual dimensions.

VENTED ADD-ON UNITS



WIDTH 24" 610 mm						
HEIGHT	LENGTH	36" 910 mm	42" 1070 mm	48" 1220 mm	54" 1380 mm	60" 1530 mm
84"	CODE - 5 SHELVES	CSA54368PKG480	CSA54428PKG480	CSA54488PKG480	CSA54548PKG480	CSA54608PKG480
	POST KIT BOX (1)	1 Post Kit	1 Post Kit	1 Post Kit	1 Post Kit	1 Post Kit
	CASE LBS. (CUBE)	21 (0.61)	21 (0.61)	21 (0.61)	21 (0.61)	21 (0.61)
	CASE KG (CUBE M³)	9,52 (0,0173)	9,52 (0,0173)	9,52 (0,0173)	9,52 (0,0173)	9,52 (0,0173)
	SHELF KIT BOX (1)	Set of 5 Shelf Kits	Set of 5 Shelf Kits	Set of 5 Shelf Kits	Set of 5 Shelf Kits	Set of 5 Shelf Kits
	CASE LBS. (CUBE)	60.6 (6.58)	73 (7.85)	80 (6.81)	91.2 (8.41)	101.6 (9.36)
2140 mm	CASE KG (CUBE M³)	27,49 (0,186)	33,11 (0,222)	36,29 (0,193)	41,37 (0,238)	46,08 (0,265)
	LIST PRICE KIT	\$ 569.60	\$ 646.05	\$ 696.10	\$ 767.30	\$ 820.10

Case Pack: Two cartons per unit.

Color: Speckled Gray (480). Dimensions provided with line drawings above are actual dimensions.

MOBILE POST KITS & CASTERS







72

Mobile Post Kits				
Casters are not included and must be ordered separately.				
HEIGHT (with casters)	WIDTH	18"	21"	24"
		460 mm	540 mm	610 mm
35"	CODE	CSPRK1835	CSPRK2135	CSPRK2435
	CASE LBS. (CUBE)	8.80 (0.32)	9.10 (0.32)	9.50 (0.32)
	CASE KG (CUBE M ³)	3,99 (0,0091)	4,13 (0,0091)	4,31 (0,0091)
	890 mm LIST PRICE KIT	\$ 66.65	\$ 68.95	\$ 69.80
59"	CODE	CSPRK1859	CSPRK2159	CSPRK2459
	CASE LBS. (CUBE)	13.80 (0.41)	14.10 (0.41)	14.50 (0.41)
	CASE KG (CUBE M ³)	6,26 (0,0116)	6,40 (0,0116)	6,58 (0,0116)
	1500 mm LIST PRICE KIT	\$ 89.95	\$ 92.30	\$ 93.10
67"	CODE	CSPRK1867	CSPRK2167	CSPRK2467
	CASE LBS. (CUBE)	15.80 (0.46)	16.10 (0.46)	16.50 (0.46)
	CASE KG (CUBE M ³)	7,17 (0,0130)	7,30 (0,0130)	7,48 (0,0130)
	1700 mm LIST PRICE KIT	\$ 97.75	\$ 100.10	\$ 100.80
75"	CODE	CSPRK1875	CSPRK2175	CSPRK2475
	CASE LBS. (CUBE)	17.55 (0.52)	17.85 (0.52)	17.32 (0.46)
	CASE KG (CUBE M ³)	7,96 (0,0147)	8,10 (0,0147)	8,28 (0,0147)
	1910 mm LIST PRICE KIT	\$ 99.85	\$ 102.20	\$ 103.00

Case Pack: 1.

Color: Speckled Gray (480).

Casters are not included and must be ordered separately.

Casters		Premium	Premium	Standard	Standard	Standard	Donut Bumper
							
	DIAMETER	5"	5"	5"	5"	5"	3 1/2"
		127 mm	127 mm	127 mm	127 mm	127 mm	90 mm
	CODE	CSCSL	CCTL	CSSB	CSCS	CSCR	CSRDB
	DESCRIPTION	Swivel with lock in one direction	Total Locking Caster	Swivel Chrome with Brake	Swivel Chrome Caster	Rigid Chrome Caster	Donut Bumper
	CASE LBS. (CUBE)	4.33 (0.17)	4.30 (0.17)	5.04 (0.17)	4.72 (0.17)	0.38 (0.17)	0.74 (0.05)
	CASE KG (CUBE M ³)	1,94 (0,005)	1,95 (0,005)	2,29 (0,005)	2,14 (0,005)	2,13 (0,005)	0,34 (0,001)
	LIST PRICE EACH	\$ 83.65	\$ 83.65	\$ 45.40	\$ 40.25	\$ 40.25	\$ 9.30







Caster Case Pack: 2.

Donut Bumper Case Pack: 4.

PREMIUM CASTERS The premium line is made with a zinc plated post and a non-marking polyurethane wheel. Recommended for use in wet areas or in walk-in refrigerators and freezers.

STANDARD CASTERS The standard casters are chrome plated and can be used for dry storage.







VENTED MOBILE STARTER UNITS

		Premium	Standard	Premium	Standard	Premium	Standard
WIDTH 18" 460 mm							
HEIGHT (with casters)	LENGTH	36" 910 mm	36" 910 mm	42" 1070 mm	42" 1070 mm	48" 1220 mm	48" 1220 mm
	67" 1700 mm	CODE - 4 SHELVES CSUR48366	CSURS48366	CSUR48426	CSURS48426	CSUR48486	CSURS48486
	CASE LBS. (CUBE)	78.8 (6)	87.36 (6.12)	87.4 (6)	96.08 (6.12)	101.36 (6.12)	101.36 (6.12)
	CASE KG (CUBE M³)	39,63 (0,173)	39,63 (0,173)	43,58 (0,173)	43,58 (0,173)	45,98 (0,173)	45,98 (0,173)
	LIST PRICE KIT	\$ 858.10	\$ 677.90	\$ 918.10	\$ 737.90	\$ 939.85	\$ 759.65
	67" 1700 mm	CODE - 5 SHELVES CSUR58366	CSURS58366	CSUR58426	CSURS58426	CSUR58486	CSURS58486
	CASE LBS. (CUBE)	98.80 (6.12)	89 (6)	109.70 (6.12)	109.70 (6.12)	116.30 (6.12)	116.30 (6.12)
	CASE KG (CUBE M³)	44,82 (0,173)	44,82 (0,173)	49,76 (0,173)	49,76 (0,173)	52,75 (0,173)	52,75 (0,173)
	LIST PRICE KIT	\$ 935.85	\$ 755.65	\$ 1,010.90	\$ 830.65	\$ 1,038.00	\$ 857.80
	75" 1910 mm	CODE - 4 SHELVES CSUR48367	CSURS48367	CSUR48427	CSURS48427	CSUR48487	CSURS48487
	CASE LBS. (CUBE)	91.4 (5.78)	89.46 (6.12)	98.18 (6.12)	98.18 (6.12)	103.46 (6.12)	103.46 (6.12)
	CASE KG (CUBE M³)	40,58 (0,173)	40,58 (0,173)	44,53 (0,173)	44,53 (0,173)	46,93 (0,173)	46,93 (0,173)
	LIST PRICE KIT	\$ 862.40	\$ 682.35	\$ 922.50	\$ 742.35	\$ 944.25	\$ 764.05
	75" 1910 mm	CODE - 5 SHELVES CSUR58367	CSURS58367	CSUR58427	CSURS58427	CSUR58487	CSURS58487
	CASE LBS. (CUBE)	100.90 (6.12)	91.4 (5.78)	99.8 (5.9)	111.80 (6.12)	118.40 (6.12)	108.4(8.35)
	CASE KG (CUBE M³)	45,77 (0,173)	45,77 (0,173)	50,71 (0,173)	50,71 (0,173)	53,71 (0,173)	53,71 (0,173)
	LIST PRICE KIT	\$ 940.15	\$ 760.05	\$ 1,015.25	\$ 835.10	\$ 1,042.45	\$ 862.25







Case Pack: 1. Color: Speckled Gray (480).

Premium Casters: include two non-corrosive swivel locking casters (CSCSL) and two total locking casters (CSCTL).

Standard Casters: include two swivel chrome casters (CSCS) and two swivel chrome with brakes (CSSB).

		Premium	Standard	Premium	Standard	Premium	Standard
WIDTH 21" 540 mm							
HEIGHT (with casters)	LENGTH	36" 910 mm	36" 910 mm	42" 1070 mm	42" 1070 mm	48" 1220 mm	48" 1220 mm
	67" 1700 mm	CODE - 4 SHELVES CSUR41366	CSURS41366	CSUR41426	CSURS41426	CSUR41486	CSURS41486
	CASE LBS. (CUBE)	90.92 (7.17)	85.6 (7.39)	101.12 (7.17)	101.12 (7.17)	106.96 (7.17)	106.96 (7.17)
	CASE KG (CUBE M³)	43,29 (0,203)	43,29 (0,203)	45,82 (0,203)	45,82 (0,203)	48,51 (0,203)	48,51 (0,203)
	LIST PRICE KIT	\$ 903.15	\$ 723.00	\$ 971.15	\$ 790.90	\$ 997.15	\$ 817.10
	67" 1700 mm	CODE - 5 SHELVES CSUR51366	CSURS51366	CSUR51426	CSURS51426	CSUR51486	CSURS51486
	CASE LBS. (CUBE)	105.60 (7.17)	103.66 (7.17)	104 (7.17)	116.35 (7.17)	123.65 (7.17)	123.65 (7.17)
	CASE KG (CUBE M³)	46,99 (0,203)	46,99 (0,203)	52,78 (0,203)	52,78 (0,203)	56,09 (0,203)	56,09 (0,203)
	LIST PRICE KIT	\$ 991.05	\$ 810.90	\$ 1,076.00	\$ 895.85	\$ 1,108.60	\$ 928.45
	75" 1910 mm	CODE - 4 SHELVES CSUR41367	CSURS41367	CSUR41427	CSURS41427	CSUR41487	CSURS41487
	CASE LBS. (CUBE)	94.42 (7.17)	87.4 (7.55)	93.6 (7.11)	96.8 (7.53)	110.46 (7.17)	110.46 (7.17)
	CASE KG (CUBE M³)	42,83 (0,203)	42,83 (0,203)	47,45 (0,203)	47,45 (0,203)	50,10 (0,203)	50,10 (0,203)
	LIST PRICE KIT	\$ 907.55	\$ 727.45	\$ 975.50	\$ 795.35	\$ 1,001.60	\$ 821.35
	75" 1910 mm	CODE - 5 SHELVES CSUR51367	CSURS51367	CSUR51427	CSURS51427	CSUR51487	CSURS51487
	CASE LBS. (CUBE)	107.10 (7.17)	107.10 (7.17)	119.85 (7.17)	107.6 (7.17)	127.15 (7.17)	127.15 (7.17)
	CASE KG (CUBE M³)	48,58 (0,203)	48,58 (0,203)	54,36 (0,203)	54,36 (0,203)	57,67 (0,203)	57,67 (0,203)
	LIST PRICE KIT	\$ 995.45	\$ 815.30	\$ 1,080.40	\$ 900.20	\$ 1,113.05	\$ 932.80

VENTED MOBILE STARTER UNITS



		Premium	Standard	Premium	Standard	Premium	Standard
WIDTH 24" 610 mm							
HEIGHT (with casters)	LENGTH	36"	36"	42"	42"	48"	48"
		910 mm	910 mm	1070 mm	1070 mm	1220 mm	1220 mm
67" 1700 mm	CODE - 4 SHELVES	CSUR44366	CSURS44366	CSUR44426	CSURS44426	CSUR44486	CSURS44486
	CASE LBS. (CUBE)	95.44 (8.01)	90.6 (8.51)	98.2 (8.07)	104.24 (8.01)	113.00 (8.01)	109.2 (8.27)
	CASE KG (CUBE M³)	43,29 (0,227)	43,29 (0,227)	47,28 (0,227)	47,28 (0,227)	51,26 (0,227)	51,26 (0,227)
	LIST PRICE KIT	\$ 917.75	\$ 737.55	\$ 978.55	\$ 798.40	\$ 1,018.65	\$ 838.65
67" 1700 mm	CODE - 5 SHELVES	CSUR54366	CSURS54366	CSUR54426	CSURS54426	CSUR54486	CSURS54486
	CASE LBS. (CUBE)	108.55 (8.01)	108.55 (8.01)	119.55 (8.01)	111.2 (8.71)	130.50 (8.01)	130.50 (8.01)
	CASE KG (CUBE M³)	49,24 (0,227)	49,24 (0,227)	54,23 (0,227)	54,23 (0,227)	59,19 (0,227)	59,19 (0,227)
	LIST PRICE KIT	\$ 1,008.75	\$ 828.60	\$ 1,085.00	\$ 904.75	\$ 1,135.15	\$ 954.90
75" 1910 mm	CODE - 4 SHELVES	CSUR44367	CSURS44367	CSUR44427	CSURS44427	CSUR44487	CSURS44487
	CASE LBS. (CUBE)	98.94 (8.01)	88.4 (8.22)	107.74 (8.01)	107.74 (8.01)	108.00 (8.16)	116.50 (8.01)
	CASE KG (CUBE M³)	44,88 (0,227)	44,88 (0,227)	48,87 (0,227)	48,87 (0,227)	52,84 (0,227)	52,84 (0,227)
	LIST PRICE KIT	\$ 922.00	\$ 741.90	\$ 983.00	\$ 802.80	\$ 1,023.15	\$ 842.90
75" 1910 mm	CODE - 5 SHELVES	CSUR54367	CSURS54367	CSUR54427	CSURS54427	CSUR54487	CSURS54487
	CASE LBS. (CUBE)	112.05 (8.01)	103.8 (8.51)	123.05 (8.01)	114.4 (8.35)	134.00 (8.01)	134.00 (8.01)
	CASE KG (CUBE M³)	50,83 (0,227)	50,83 (0,227)	55,82 (0,227)	55,82 (0,227)	60,78 (0,227)	60,78 (0,227)
	LIST PRICE KIT	\$ 1,013.10	\$ 833.05	\$ 1,089.30	\$ 909.20	\$ 1,139.50	\$ 959.35

Case Pack: 1. Color: Speckled Gray (480).

Premium Casters: include two non-corrosive swivel locking casters (CSCSL) and two total locking casters (CSCTL).

Standard Casters: include two swivel chrome casters (CSCS) and two swivel chrome with brakes (CSSB).

FENCE SYSTEM

PRODUCT	FITS	24"	30"	36"	42"	48"	54"	60"	72"
		610 mm	760 mm	910 mm	1070 mm	1220 mm	1380 mm	1530 mm	1830 mm
Double Level Traverse Fence 4" (10 cm) 	CODE	CSFT242	CSFT302	CSFT362	CSFT422	CSFT482	CSFT542	CSFT602	CSFT722
	# OF BRACKETS	2	2	2	3	4	4	4	5
	# OF RODS	2	2	2	2	2	2	2	2
	CASE LBS. (CUBE)	1.94 (0.23)	2.06 (0.30)	2.17 (0.37)	2.31 (0.43)	2.43 (0.50)	2.56 (0.57)	2.68 (0.64)	2.93 (0.77)
	CASE KG (CUBE M³)	3,53 (0,0235)	4,36 (0,0235)	5,19 (0,0235)	6,03 (0,0274)	6,85 (0,0300)	7,68 (0,035)	18,30 (0,0390)	10,07 (0,0470)
	LIST PRICE KIT	\$ 23.95	\$ 26.35	\$ 28.75	\$ 32.05	\$ 34.55	\$ 37.80	\$ 40.20	\$ 45.95
Single Level Traverse Fence 2" (5 cm) 	CODE	CSFT241	CSFT301	CSFT361	CSFT421	CSFT481	CSFT541	CSFT601	CSFT721
	# OF BRACKETS	2	2	2	3	3	4	4	5
	# OF RODS	1	1	1	1	1	1	1	1
	CASE LBS. (CUBE)	1.74 (0.13)	1.80 (0.17)	1.86 (0.21)	1.91 (0.25)	1.99 (0.29)	2.07 (0.33)	2.13 (0.37)	2.27 (0.45)
	CASE KG (CUBE M³)	3,78 (0,0235)	4,63 (0,0235)	5,47 (0,0235)	6,53 (0,0274)	7,16 (0,0300)	8,22 (0,0351)	9,05 (0,0390)	10,84 (0,0470)
	LIST PRICE KIT	\$ 18.15	\$ 19.35	\$ 20.55	\$ 21.85	\$ 23.70	\$ 25.60	\$ 26.80	\$ 29.90

PRODUCT	FITS	14"	18"	21"	24"
		360 mm	460 mm	540 mm	610 mm
End Fence 	CODE	CSFE14	CSFE18	CSFE21	CSFE24
	# OF BRACKETS	2	2	2	2
	# OF RODS	2	2	2	2
	CASE LBS. (CUBE)	1.73 (0.03)	1.81 (0.05)	1.87 (0.06)	1.93 (0.07)
	CASE KG (CUBE M³)	3,53 (0,0235)	4,36 (0,0235)	5,19 (0,0235)	6,03 (0,0274)
	LIST PRICE KIT	\$ 18.10	\$ 19.60	\$ 20.70	\$ 21.85

Case Pack: 1.

Color: Speckled Gray (480).

SECURITY CAGE FOR CAMSHELVING®

- Provides safe storage for valuables such as wine, champagne and spirits.
- Ideal for securing personal items such as purses and backpacks.
- Unique modular design provides the flexibility to retrofit one shelf at a time or an entire shelving unit.



Fits on US Standard Camshelving Units 24" (61 cm) wide, 48" (122 cm) in length and longer.



CODE	DIMENSIONS W X L X H	CASE LBS. (CUBE)	LIST PRICE EA.
CSSC2448	25¼" x 42½" x 18" (64 x 108 x 46 cm)	31½ (5.73)	\$ 640.00

Case Pack: 1 Padlock not included.

CAMSHELVING® DOME DRYING AND STORAGE CART

Ideal for use with healthcare, long term care & correctional meal delivery systems.



- Keeps trayline and dishwashing area organized and efficient.
- Securely holds 100 domes, pellets and/or pellet underliners.
- Cradles made of stainless steel.
- Shelving posts and traverses feature a steel core with a smooth polypropylene exterior.
- Cradles are removable and fit into a Camrack® Base Rack (BR258) for dishwasher service.
- Individual drying cradles are also available to retrofit existing shelving units.

Camshelving Dome Drying Carts will ship in three separate cartons: One carton contains two 75" high by 18" wide post kits, ten 36" long traverses and 4 casters. Two cartons contain 5 drying cradles each.

Please refer to our Shoreline Collection in the Table Service Section for our full line of healthcare meal delivery systems.



CODE	DESCRIPTION	DIMENSIONS L x W x H	CASE LBS. (CUBE)	LIST PRICE EA.
CSDDCPKG480	Dome Drying and Storage Cart Carton 1: 2 Post Kits, 10 Traverses and 4 Casters Carton 2: Set of 5 Drying Cradles Carton 3: Set of 5 Drying Cradles	36" x 18" x 75"	80.0 (5.21) 17.0 (2.51) 17.0 (2.51)	\$2,100.00
CSDC	Dome Drying Cradle	17¼" x 10" x 16"	4.50 (1.89)	\$136.00

Case Pack: 1 Color: Cart - 480 (Speckled Gray), Cradle - 000 (Stainless Steel)

CAMSHELVING® WALL SHELVES AND STORESAFE® SHELF EXTENDERS

Wall Shelves

- Expand storage space in kitchens, above work stations and sinks.
- Features virtually indestructible I-beam supports that hold up to 150 lbs. (68 Kg) per shelf.
- Durable polypropylene withstands temperatures up to 190°F (88°C), and will not rust or corrode.

- Snap fit rail design allows shelves to snap on and off for easy cleaning.
- 2" (5 cm) backsplash and marine front edge controls spills and cross contamination.

Shelf Extenders

- Convert empty wall space into a functional storage area.
- Use with or without Camshelving Wall Shelves.
- Peg strips withstand temperatures up to 190°F (88°C), and will not rust or corrode.

Shelf Extenders ship in one carton with all hardware and includes:

LENGTH	PEG STRIPS	BRACKETS	HOOKS
36"	3	2	6
48"	3	3	9



Wall Shelf Color: Speckled Gray (480).

Extender Peg Strip Color: Black (110).

Wall Shelf Kits are covered by the following U.S. Patents D 508,646S & D 512,867 S.



CODE	CSWS1436SK	CSWS1448SK	CSWS1436VK	CSWS1448VK
DESCRIPTION	36" x 14" Wall Shelf, Solid	48" x 14" Wall Shelf, Solid	36" x 14" Wall Shelf, Vented	48" x 14" Wall Shelf, Vented
EXTERIOR DIMENSIONS	L 36" x W 14" x H 13½"	L 48" x W 14" x H 13½"	L 36" x W 14" x H 13½"	L 48" x W 14" x H 13½"
CASE LBS. (CUBE)	10 (1.31)	12.50 (1.73)	9.75 (1.31)	11.50 (1.73)
LIST PRICE KIT	\$130.00	\$150.00	\$130.00	\$150.00

Case Pack: 1

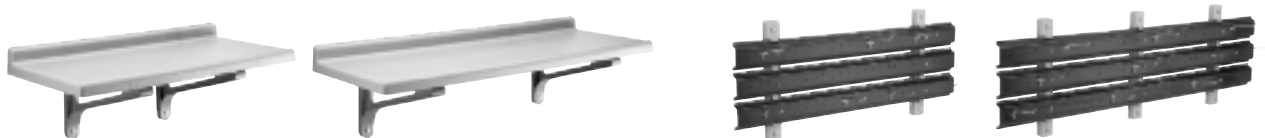

CODE	CSWS1836SK	CSWS1848SK	CSWS36EK	CSWS48EK
DESCRIPTION	36" x 18" Wall Shelf, Solid	48" x 18" Wall Shelf, Solid	36" Shelf Extender	48" Shelf Extender
EXTERIOR DIMENSIONS	L 36" x W 18" x H 13½"	L 48" x W 18" x H 13½"	L 35½" x W 2" x H 15½"	L 47½" x W 2" x H 15½"
CASE LBS. (CUBE)	11.77 (1.54)	14.45 (2.05)	6 (0.37)	8.25 (0.49)
LIST PRICE KIT	\$150.00	\$165.00	\$205.00	\$305.00

Case Pack: 1

DUNNAGE RACKS & PIZZA DOUGH BOXES

S-Series Dunnage Racks

- Keep frozen, cold or dry inventory 12" (30,5 cm) safely off the floor.
- One piece construction and sturdy legs provide strength and stability.
- Heavy duty polypropylene is safe to -36°F (-38°C), and will not rust, corrode or bend.
- Choose slotted tops for maximum air circulation around perishable products.
- Solid tops catch spills for easy clean up.

Colors: Dark Brown (131), Speckled Gray (480).



CODE	EXTERIOR DIMENSIONS H x D x W	LOAD CAPACITY	CASE LBS. (CUBE)	LIST PRICE EA.
Solid Top				
DRS30	12" x 21" x 30"	1500 lbs.	22.05 (4.75)	\$ 195.00
DRS36	12" x 21" x 36"	1500 lbs.	26 (5.72)	210.00
DRS48	12" x 21" x 48"	3000 lbs.	35.10 (7.41)	255.00
DRS60	12" x 21" x 60"	3000 lbs.	44.66 (9.53)	290.00
Slotted Top				
DRS300	12" x 21" x 30"	1500 lbs.	20 (4.78)	195.00
DRS360	12" x 21" x 36"	1500 lbs.	25 (5.72)	210.00
DRS480	12" x 21" x 48"	3000 lbs.	34.07 (7.45)	255.00
DRS600	12" x 21" x 60"	3000 lbs.	42.37 (9.36)	290.00

Case Pack: 1 InStock Color: Speckled Gray (480).

Camlink

Camlink connectors securely lock dunnage racks together for greater stability.



Color: Black (110).

Camlink is covered by U.S. Patent D 397,289.

Camlink fits all sizes and styles. One free Camlink supplied with every Dunnage Rack.

CODE	CASE PACK	LIST PRICE EA.
DRLNK	6	\$ 2.40



Pizza Dough Boxes

- Ideal for pizza dough storage, transport, proofing and cooling.
- Dough boxes nest together for a dust free and tight fit, preventing crusting and increasing the storage life of dough.
- Available in durable polypropylene which is lightweight, easy to clean and chemical resistant, or virtually unbreakable Camwear® polycarbonate.

Color: White (148).

Camwear® Polycarbonate Boxes and Covers are NSF listed.



CODE	OUTSIDE DIMENSIONS	INSIDE DIMENSIONS	CASE LBS. (CUBE)	LIST PRICE EA.
Camwear® Pizza Dough Boxes				
DB18263CW	18" x 26" x 3"	16" x 24"	24.03 (4.62)	\$ 45.60
DB18266CW	18" x 26" x 6"	16" x 24"	35.5 (9.47)	61.30
Camwear® Cover				
DBC1826CW	18" x 26"	—	14.81 (1.21)	33.25

Case Pack: 6

Polypropylene Pizza Dough Box

DB18263P	18" x 26" x 3"	16" x 24"	24.35 (5.37)	42.25
-----------------	----------------	-----------	--------------	-------

Polypropylene Cover

DBC1826P	18" x 26"	—	17.85 (2.27)	28.00
-----------------	-----------	---	--------------	-------

Case Pack: 6. InStock Color: White (148)



DB18266CW

DB18263CW

*Polycarbonate & Polypropylene dough boxes do not inter stack.



DB18263P



CD1826PDB

See Camdolly Section for Camdolly for Pizza Dough Box.

STORESAFE® FOOD ROTATION LABELS

- Label and adhesive dissolve in less than 30 seconds.
- Leaves behind no sticky residue which can be a breeding ground for bacteria.
- Assists in a proper First In First Out (FIFO) food storage system.
- Run under hot or cold water or through the dishwasher.
- Safe for all sewer and septic systems. Will not build up in drains.
- Withstands high heat temperatures up to 200°F (93°C) for 4 hours. Microwave safe.
- Withstands freezer temperatures up to -40°F (-40°C).

Label color: White.

*Available for ordering in cases only. No broken cartons.

100% biodegradable. FDA approved material.



Eliminates sticky residue and prevents cross contamination! No more scraping!



Dissolves completely within 30 seconds off all containers when placed through dishwasher or under running water.

100%
Dissolvable
and
Biodegradable



Retail Blister Pack



CASE CODE	23SL
LABEL SIZE	2" x 3"
CASE PACK	20 rolls, 100 labels per roll
CASE LBS. (CUBE)	5 (1.2)
CASE PRICE*	\$ 370.00

Half Size Bulk Dispenser Pack



CASE CODE	1252SLB250	1252SLINB250
LABEL SIZE	1½" x 2"	1¼" x 2"
CASE PACK	24 rolls, 250 labels per roll	24 rolls, 250 labels per roll
CASE LBS. (CUBE)	3.21 (0.26)	4.93 (0.26)
CASE PRICE*	\$ 340.00	\$ 340.00

Bulk Dispenser Pack



CASE CODE	23SLB250	23SLB6250
LABEL SIZE	2" x 3"	2" x 3"
CASE PACK	24 rolls, 250 labels per roll	6 rolls, 250 labels per roll
CASE LBS. (CUBE)	10.61 (0.3)	2.75 (0.12)
CASE PRICE*	\$ 685.00	\$ 178.00

Blank Bulk Dispenser Pack



CASE CODE	23SLINB250
LABEL SIZE	2" x 3"
CASE PACK	24 rolls, 250 labels per roll
CASE LBS. (CUBE)	10.86 (0.37)
CASE PRICE*	\$ 685.00

Laser Sheet



CASE CODE	SLL30	A4SLL21
LABEL SIZE	1" x 2½" (Avery® 5160)	1½" x 2½" (Avery® J8160)
CASE PACK	100 sheets, 30 labels per sheet 8½" x 11" sheet size	100 sheets 21 labels per sheet **8¼" x 11½" sheet size
CASE LBS. (CUBE)	2.42 (0.09)	2.5 (0.08)
BOX PRICE*	\$ 175.00	\$ 175.00

** A4 international sheet format. **InStock Color:** White.

QUICK GUIDE TO STORAGE SOLUTIONS



Food Storage products can be personalized to identify menu items, add fill lines for recipes or provide instructions in multiple languages.

See the “Let’s Get Personal” directions in the Table Service section to order personalized storage containers.



Look for this icon that identifies items that can be personalized.

With our wide variety of containers, we have all the right solutions for safely storing ingredients and prepared food.

Food Storage Containers



Rounds

- Round shape promotes air circulation.
- Ideal for stirring sauces and soups.
- Available in Camwear® polycarbonate, translucent, and poly.



CamSquares®

- Space efficient storage.
- Available in Camwear polycarbonate, translucent, and poly.



Food Boxes

- Safely store bulk produce, meat, poultry and seafood.
- Exclusive SlidingLid™ allows quick product retrieval.
- Available in Camwear polycarbonate and poly.



Ingredient Bins

- Store dry bulk ingredients such as flour and grain.
- Slide back lid provides easy access.

Food Pans



Camwear Food Pans

- Store, transport and serve all in one pan.
- Lids protect contents and extend product freshness.



Translucent Food Pans

- Economical storage choice.
- Ideal for food bars, prep tables, storage and transport.



H-Pans™

- Pans can go from prep to cooler to oven to steam table.
- Safe for use in microwave ovens.



ColdFest®

- Holds cold food at safe temperatures without ice.

Materials

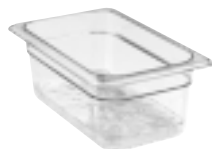

Camwear Polycarbonate

- Virtually unbreakable, clear polycarbonate.
- Non-porous, smooth surface is easy to clean. Stain resistant. Not harmed by food acids, oils or alcohol.
- Temperature range: -40°F to 210°F (-40°C to 99°C).
- Clear (135), White (148) and Black (110).

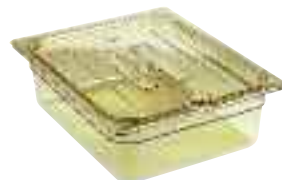

Heat Resistant H-Pans™

- Excellent for steam table and microwave ovens.
- Temperature range: -40°F to 375°F (-40°C to 190°C).
- Amber (150), Black (110).



Translucent

- High chemical resistance.
- Temperature range: -40°F to 160°F (-40°C to 70°C)
Safe in high temperature dishwasher.
- Translucent (190).



Poly

- High chemical and stain resistance.
- Good impact resistance.
- Temperature range: -40°F to 160°F (-40°C to 70°C)
Safe in high temperature dishwasher.
- White (148).

CAMWEAR® POLYCARBONATE CAMSQUARE® FOOD STORAGE CONTAINERS

Maximize your storage area with CamSquare food storage containers. The square shape provides 33% better space usage than traditional round containers. Clear polycarbonate provides product visibility for at a glance inventory management. New seal covers feature an inner and outer seal for superior spill resistance, even during transport.

Note: All graduations are approximate.
 ** Dimensions include handles.



Tight fitting Seal Cover is spill resistant, saves expense & is safer for employees to handle during transport.

Interstacking saves space when not in use.



Wide molded-in handles on larger sizes ease carrying. Molded-in holes offer quick and sanitary drying.

Stain and odor resistant.

Crystal clear, virtually unbreakable Camwear® polycarbonate withstands temperatures from -40°F to 210°F (-40°C to 99°C).

Easy to read graduations printed on the outside for quick inventory management.

Seal Covers for Camwear CamSquares*



- Inner and outer seal provide excellent spill resistance.
- Includes a hole on the corner for hanging during storage.
- Translucent lid easily identifies contents.
- Withstands temperatures from -40°F to 160°F (-40°C to 70°C).



*Seal covers only fit Camwear Square Containers.

CAMSQUARE® FOOD STORAGE CONTAINERS

Translucent

- Translucent material provides some content visibility and high chemical resistance.
- Withstands temperatures from -40°F to 160°F (-40°C to 70°C).
- Easy to read graduations are printed on the outside for at a glance inventory management.

Note: All graduations are approximate.



Poly

- Economical storage choice.
- Made of impact, stain and chemical resistant material.
- Withstands temperatures from -40°F to 160°F (-40°C to 70°C).

Note: All graduations are approximate.



Covers for CamSquares

- Snap-tight polyethylene covers feature thumb tabs for easy removal.
- Covers fit Camwear®, Translucent and Poly CamSquare Containers.



Personalized Storage Products

Personalize food storage products to identify menu items, add fill lines for recipes, or use personalization in multiple languages to help ensure product quality and consistency.



CAMWEAR® POLYCARBONATE CAMSQUARE® FOOD STORAGE CONTAINERS



Camwear®



CODE	2SFSCW	4SFSCW	6SFSCW	8SFSCW	New! 12SFSCW**	New! 18SFSCW**	New! 22SFSCW**
CAPACITY	2 qt.	4 qt.	6 qt.	8 qt.	12 qt.	18 qt.	22 qt.
DIM. L x W x H	7¼" x 7¼" x 3½"	7¼" x 7¼" x 7½"	8¾" x 8¾" x 7¾"	8¾" x 8¾" x 9¾"	11¼" x 12¼" x 8¾"	11¼" x 12¼" x 12¾"	11¼" x 12¼" x 15¾"
CASE LBS. (CUBE)	3.34 (0.42)	5.28 (0.61)	7.01 (0.97)	8.41 (1.09)	12.98 (2.31)	19.65 (2.74)	24.3 (3.05)
LIST PRICE EACH	\$ 7.90	\$ 12.10	\$ 15.65	\$ 18.40	\$ 24.50	\$ 36.35	\$ 46.05

Case Pack: 6

Color/InStock Color: Clear (135).

Height includes covers.

Seal Covers For Camwear Camsquares



CODE	New! SFC2SCPP	New! SFC6SCPP	New! SFC12SCPP
DESCRIPTION	Fits 2 & 4 qt.	Fits 6 & 8 qt.	Fits 12, 18 & 22 qt.
CASE LBS. (CUBE)	1.25 (0.11)	1.57 (0.16)	2.54 (0.25)
LIST PRICE EACH	\$ 3.10	\$ 3.85	\$ 5.60

Case Pack: 6

InStock Color: Translucent (190)

Note: All graduations are approximate.

* Seal covers fit Camwear Polycarbonate CamSquare containers only.

** Dimensions include handles.



CAMSQUARE® FOOD STORAGE CONTAINERS



Translucent



CODE	2SFSP	4SFSP	6SFSP	8SFSP	12SFSP**	18SFSP**	22SFSP**
CAPACITY	2 qt.	4 qt.	6 qt.	8 qt.	12 qt.	18 qt.	22 qt.
DIM. L x W x H	7¼" x 7¼" x 3⅝"	7¼" x 7¼" x 7⅞"	8⅞" x 8⅞" x 7¼"	8⅞" x 8⅞" x 9⅞"	11¼" x 12¼" x 8⅞"	11¼" x 12¼" x 12⅞"	11¼" x 12¼" x 15⅞"
CASE LBS. (CUBE)	2.6 (0.42)	4.45 (0.61)	5.62 (0.98)	6.87 (1.05)	9 (2.34)	14.75 (2.74)	19.10 (3.01)
LIST PRICE EACH	\$ 5.90	\$ 8.05	\$ 10.00	\$ 11.85	\$ 16.70	\$ 22.75	\$ 28.00

Case Pack: 6 Color/InStock Color: Translucent (190). Height includes covers.

Poly

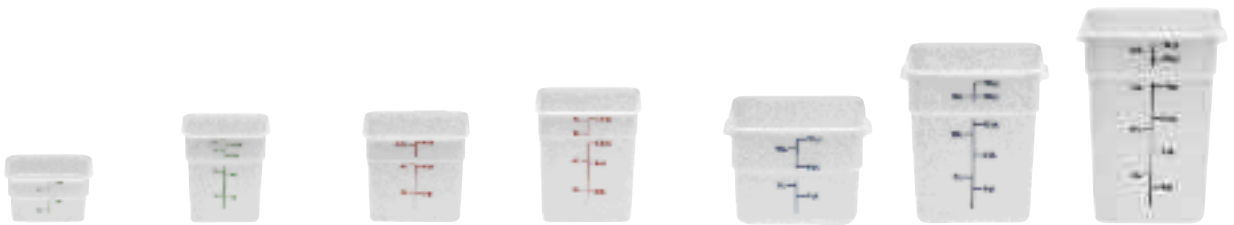

CODE	2SFSP	4SFSP	6SFSP	8SFSP	12SFSP**	18SFSP**	22SFSP**
CAPACITY	2 qt.	4 qt.	6 qt.	8 qt.	12 qt.	18 qt.	22 qt.
DIM. L x W x H	7¼" x 7¼" x 3⅝"	7¼" x 7¼" x 7⅞"	8⅞" x 8⅞" x 7¼"	8⅞" x 8⅞" x 9⅞"	11¼" x 12¼" x 8⅞"	11¼" x 12¼" x 12⅞"	11¼" x 12¼" x 15⅞"
CASE LBS. (CUBE)	2.43 (0.41)	4.49 (0.61)	5.66 (0.93)	7.4 (1.06)	9 (2.34)	14.75 (2.74)	20.25 (3.05)
LIST PRICE EACH	\$ 5.55	\$ 7.60	\$ 9.40	\$ 11.20	\$ 15.95	\$ 21.55	\$ 26.35

Case Pack: 6 Color: Natural White (148). Height includes covers.

Covers*



CODE	SFC2	SFC6	SFC12
COLOR	Kelly Green (452)	Winter Rose (451)	Midnight Blue (453)
DESCRIPTION	Fits 2 & 4 qt.	Fits 6 & 8 qt.	Fits 12, 18 & 22 qt.
CASE LBS. (CUBE)	1.25 (0.11)	1.64 (0.16)	2.54 (0.25)
LIST PRICE EACH	\$ 3.10	\$ 3.85	\$ 5.60

Case Pack: 6 InStock Color: Kelly Green (452), Winter Rose (451), Midnight Blue (453).

Note: All graduations are approximate.

* PolyCovers fit Camwear, Translucent and Poly CamSquare Containers.

** Dimensions include handles.



CAMWEAR® POLYCARBONATE ROUND FOOD STORAGE CONTAINERS

Store ingredients or transport ready to serve or partially prepared foods. Clear Camwear polycarbonate allows for easy content identification at a glance. Reduces risk of contamination and enhances food safety. Round shape promotes proper air circulation, ideal for stirring soups and sauces.

Note: All graduations are approximate.

Note: To order Round Food Storage Containers without imprinted graduations, simply add "N" to the end of the code number.

Lids are not interchangeable.



Seal Cover provides excellent spill resistance.

Crystal clear, virtually unbreakable Camwear polycarbonate withstands temperatures from -40°F to 210°F (-40°C to 99°C).

Molded-in handles ease carrying. Molded-in holes offer quick and sanitary drying.

Resists food acids, oils & alcohol. Stain and odor resistant.

Interstacking saves space when not in use.

Easy to read graduations on the outside for at a glance inventory management.



Camwear Polycarbonate Covers

- Snap on covers fit tightly.
- Stain resistant to food acids and oils.
- Withstands temperatures from -40°F to 210°F (-40°C to 99°C).



Round Seal Covers

- Inner and outer seal provide excellent spill resistance.
- Safe from -40°F to 160°F (-40°C to 70°C).
- Thumb tab for easy removal.



ROUND FOOD STORAGE CONTAINERS

Translucent

- Translucent material offers some product visibility.
- Rounds are durable and resistant to stains.
- Withstands temperatures from -40°F to 160°F (-40°C to 70°C).
- Snap on covers fit tightly to protect contents and extend product freshness.

Note: All graduations are approximate.

Note: To order Round Food Storage Containers without imprinted graduations, simply add "N" to the end of the code number.

Lids are not interchangeable.



1.800.833.3003

85

www.cambro.com

Poly

- Impact, stain and chemical resistant material.
- An affordable storage choice.
- Safe from -40°F to 160°F (-40°C to 70°C).
- Snap on covers fit tightly yet are easily removed.

Note: All graduations are approximate.

Note: To order Round Food Storage Containers without imprinted graduations, simply add "N" to the end of the code number.

Lids are not interchangeable.



CAMWEAR® POLYCARBONATE ROUND FOOD STORAGE CONTAINERS



Camwear Polycarbonate



CODE	RFSCW1	RFSCW2	RFSCW4	RFSCW6	RFSCW8	RFSCW12	RFSCW18	RFSCW22
CAPACITY	1 qt.	2 qt.	4 qt.	6 qt.	8 qt.	12 qt.	18 qt.	22 qt.
DIMENSIONS	Top Dia. 6 ¹ / ₁₆ " Height 5"	Top Dia. 8 ³ / ₁₆ " Height 4 ³ / ₁₆ "	Top Dia. 8 ⁷ / ₁₆ " Height 8 ⁷ / ₁₆ "	Top Dia. 9 ¹⁵ / ₁₆ " Height 7 ¹⁵ / ₁₆ "	Top Dia. 9 ¹⁵ / ₁₆ " Height 10 ⁷ / ₈ "	Top Dia. 14 ⁷ / ₈ " Height 8 ³ / ₈ "	Top Dia. 14 ⁷ / ₈ " Height 12"	Top Dia. 14 ⁷ / ₈ " Height 15"
CASE PACK	12	12	12	12	12	6	6	6
CASE LBS. (CUBE)	4.50 (0.44)	6.57 (0.70)	10.75 (0.83)	3.47 (.31)	15.75 (1.46)	11.52 (1.79)	16.25 (2.63)	19.17 (3.27)
LIST PRICE EACH	\$ 6.15	\$ 8.50	\$ 14.40	\$ 16.85	\$ 21.35	\$ 30.15	\$ 41.35	\$ 47.60

Color/InStock Color: Clear (135). Top diameter dimension includes handle. Height dimension includes cover.



Camwear Covers

DESCRIPTION	CASE PACK	CODE	CASE LBS. (CUBE)	LIST PRICE EA.
Fits 1 qt.	12	RFSCWC1	1.25 (0.08)	\$ 2.20
Fits 2 & 4 qt.	12	RFSCWC2	2.75 (0.24)	4.00
Fits 6 & 8 qt.	12	RFSCWC6	3.47 (0.31)	5.05
Fits 12, 18 & 22 qt.	6	RFSCWC12	4.2 (0.42)	11.55

Color/InStock Color: Clear (135).

Seal Covers for Camwear Rounds

DESCRIPTION	CASE PACK	CODE	CASE LBS. (CUBE)	LIST PRICE EA.
Fits 1 qt.	12	RFS1SCPP	1.04 (0.05)	\$ 1.80
Fits 2 & 4 qt.	12	RFS2SCPP	2.03 (0.37)	2.75
Fits 6 & 8 qt.	12	RFS6SCPP	2.7 (0.27)	2.85
Fits 12, 18 & 22 qt.	6	RFS12SCPP	3.23 (0.51)	6.15

Color/InStock Color: Translucent (190).

ROUND FOOD STORAGE CONTAINERS



Translucent



CODE	RFS1PP	RFS2PP	RFS4PP	RFS6PP	RFS8PP	RFS12PP	RFS18PP	RFS22PP
CAPACITY	1 qt.	2 qt.	4 qt.	6 qt.	8 qt.	12 qt.	18 qt.	22 qt.
DIMENSIONS	Top Dia. 6 ¹ / ₁₆ " Height 5"	Top Dia. 8 ³ / ₁₆ " Height 4 ³ / ₁₆ "	Top Dia. 8 ³ / ₁₆ " Height 8 ³ / ₁₆ "	Top Dia. 9 ¹⁵ / ₁₆ " Height 7 ¹⁵ / ₁₆ "	Top Dia. 9 ¹⁵ / ₁₆ " Height 10"	Top Dia. 14 ⁷ / ₈ " Height 8 ³ / ₈ "	Top Dia. 14 ⁷ / ₈ " Height 12"	Top Dia. 14 ⁷ / ₈ " Height 15"
CASE PACK	12	12	12	12	12	6	6	6
CASE LBS. (CUBE)	2.9 (0.45)	3.68 (0.68)	6 (0.83)	8.50 (1.44)	11.35 (1.40)	7.26 (1.74)	10 (2.63)	3.70 (1.56)
LIST PRICE EACH	\$ 3.75	\$ 4.15	\$ 4.90	\$ 5.90	\$ 7.85	\$ 13.90	\$ 16.90	\$ 19.85

Color/InStock Color: Translucent (190). Top diameter dimension includes handle. Height dimension includes cover.

Poly



CODE	RFS1	RFS2	RFS4	RFS6	RFS8	RFS12	RFS18	RFS22
CAPACITY	1 qt.	2 qt.	4 qt.	6 qt.	8 qt.	12 qt.	18 qt.	22 qt.
DIMENSIONS	Top Dia. 6 ¹ / ₁₆ " Height 5"	Top Dia. 8 ³ / ₁₆ " Height 4 ³ / ₁₆ "	Top Dia. 8 ³ / ₁₆ " Height 8 ³ / ₁₆ "	Top Dia. 9 ¹⁵ / ₁₆ " Height 7 ¹⁵ / ₁₆ "	Top Dia. 9 ¹⁵ / ₁₆ " Height 10"	Top Dia. 14 ⁷ / ₈ " Height 8 ³ / ₈ "	Top Dia. 14 ⁷ / ₈ " Height 12"	Top Dia. 14 ⁷ / ₈ " Height 15"
CASE PACK	12	12	12	12	12	6	6	6
CASE LBS. (CUBE)	3.06 (0.44)	3.96 (0.66)	6.25 (0.95)	8.76 (1.36)	11.57 (1.41)	7.50 (1.83)	10.24 (2.49)	13.61 (3.28)
LIST PRICE EACH	\$ 3.60	\$ 3.90	\$ 4.50	\$ 5.55	\$ 7.30	\$ 13.10	\$ 15.90	\$ 18.70

Color: Natural White (148). Top diameter dimension includes handle. Height dimension includes cover.

Covers for Translucent Rounds

DESCRIPTION	CASE PACK	CODE	CASE LBS. (CUBE)	LIST PRICE EA.
Fits 1 qt.	12	RFSC1PP	0.6 (0.08)	\$ 1.40
Fits 2 & 4 qt.	12	RFSC2PP	1.40 (0.13)	1.45
Fits 6 & 8 qt.	12	RFSC6PP	2.10 (0.20)	2.10
Fits 12, 18 & 22 qt.	6	RFSC12PP	3.6 (0.42)	4.80

Color/InStock Color: Translucent (190).

Covers for Poly Rounds

DESCRIPTION	CASE PACK	CODE	CASE LBS. (CUBE)	LIST PRICE EA.
Fits 1 qt.	12	RFSC1	0.78 (0.08)	\$ 1.30
Fits 2 & 4 qt.	12	RFSC2	1.44 (0.13)	1.35
Fits 6 & 8 qt.	12	RFSC6	2.2 (0.21)	1.90
Fits 12, 18 & 22 qt.	6	RFSC12	3.75 (0.42)	4.55

Color: Natural White (148).

CAMWEAR® FOOD STORAGE BOXES – Eliminate the hazard of cross contamination.

Extend the freshness of ingredients and eliminate points of cross contamination by transferring product into food boxes at the receiving dock. A safe solution for storing bulk fruits and vegetables. Clear polycarbonate allows visibility for product identification. Snap tight Camwear covers or SlidingLids™, sold separately, won't come off during transportation.

SlidingLids are covered by the following U.S. Patents D 447,906 S & D 6,540,098 B1.



SlidingLid provides easy access

Molded-in handles ease carrying.

Withstands temperatures from -40°F to 210°F (-40°C to 99°C) for use in coolers and freezers.

Crystal clear, durable Camwear polycarbonate allows for easy product identification.

Smooth surface is easy to clean. Stain and odor resistant.

Texturing on bottom of boxes reduces scratching.

Camwear Flat Lids

- Snap-tight covers won't come off during transport.
- Top molded-in rails for safer, more secure stacking.
- Durable Camwear polycarbonate is safe from -40°F to 210°F (-40°C - 99°C).

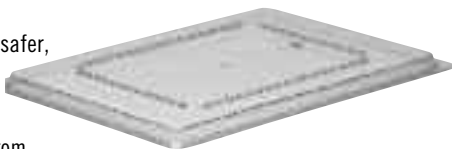

Camwear SlidingLids™ fits Camwear Food Storage Boxes

- Lid slides back to easily access contents, minimizing handling.
- Reduces the risk of cross contamination since lid remains on food box.
- Made of virtually unbreakable Camwear polycarbonate.



FOOD STORAGE BOXES

ColanderKits™

- A complete food safety system packaged in one carton.
- Store raw meats, fish on ice or bulk produce safely.
- Juices and liquids drip into the food box below for quick and easy disposal.
- Reduces handling and risk of cross contamination.



Camwear® Colanders

- Enhances food quality and reduces risk of cross contamination.
- Liquids and juices drain directly into food box for improved food safety.
- Ideal for draining fruits and vegetables, thawing meat or poultry, or storing seafood on ice.



Camwear Drain Shelves

- Lifts contents out of liquids to enhance food quality and freshness.
- Made of virtually unbreakable polycarbonate.
- Camwear drain shelves fit in both Camwear boxes and white poly boxes.



Poly Food Storage Boxes

- Economical choice for storing bulk produce and ingredients.
- Impact, stain and chemical resistant material.
- Withstands temperatures from -40°F to 160°F (-40°C - 70°C).



Camwear Safety Red Food Storage Boxes

- Helps prevent cross-contamination between raw meats and other food products.
- Red color clearly identifies product inside.
- Matching flat cover also available.



CAMWEAR® FOOD BOXES



Camwear® Polycarbonate



CODE	18263CW	● 18266CW	18269CW
DIMENSIONS	18" x 26" x 3½"	18" x 26" x 6"	18" x 26" x 9"
APPROX. CAPACITY	5.0 gal.	8.75 gal.	13.0 gal.
CASE PACK	6	6	4
CASE LBS. (CUBE)	21.93 (2.14)	30.05 (4.61)	27.03 (4.45)
LIST PRICE EACH	\$ 40.75	\$ 52.80	\$ 69.45

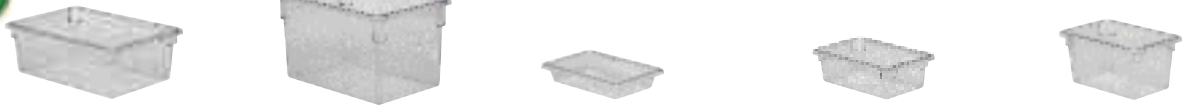

CODE	182612CW	182615CW	12183CW	● 12186CW	12189CW
DIMENSIONS	18" x 26" x 12"	18" x 26" x 15"	12" x 18" x 3½"	12" x 18" x 6"	12" x 18" x 9"
APPROX. CAPACITY	17.0 gal.	22.0 gal.	1.75 gal.	3.0 gal.	4.75 gal.
CASE PACK	4	3	6	6	6
CASE LBS. (CUBE)	34.4 (5.56)	31.68 (6.56)	12.15 (1.01)	16.02 (2.13)	20.45 (2.70)
LIST PRICE EACH	\$ 84.60	\$ 99.80	\$ 22.30.	\$ 28.25	\$ 37.95

Color/InStock Color: Clear (135). 18266CW & 12186CW are available in Clear & Red.
 ● Safety Red (467).

Camwear® Covers



CODE	● 1826CCW FLAT LID	1826SCCW SLIDINGLID™	● 1218CCW FLAT LID	1218SCCW SLIDINGLID™
DIMENSIONS	18" x 26"	18" x 26"	12" x 18"	12" x 18"
CASE LBS. (CUBE)	16.01 (0.92)	19.03 (1.72)	7.88 (0.49)	9.50 (0.72)
LIST PRICE EACH	\$ 27.65	\$ 49.50	\$ 13.80	\$ 29.45

Case Pack: 6 Color/InStock Color: Clear (135). 1826CCW & 1218CCW are available in Clear & Red.
 ● Safety Red (467).

FOOD STORAGE BOXES



1.800.833.3003

91

www.cambro.com

Poly Boxes



CODE	18263P	18266P	18269P
DIMENSIONS	18" x 26" x 3½"	18" x 26" x 6"	18" x 26" x 9"
APPROX. CAPACITY	5.0 gal.	8.75 gal.	13.0 gal.
CASE PACK	6	6	6
CASE LBS. (CUBE)	16.22 (2.16)	28.76 (4.28)	31.81 (5.58)
LIST PRICE EACH	\$ 27.05	\$ 35.50	\$ 46.35



CODE	182612P	182615P	12183P	12186P	12189P
DIMENSIONS	18" x 26" x 12"	18" x 26" x 15"	12" x 18" x 3½"	12" x 18" x 6"	12" x 18" x 9"
APPROX. CAPACITY	17.0 gal.	22.0 gal.	1.75 gal.	3.0 gal.	4.75 gal.
CASE PACK	4	3	6	6	6
CASE LBS. (CUBE)	34.4 (5.56)	27.25 (6.56)	9.42 (0.91)	11.97 (1.98)	16.45 (2.54)
LIST PRICE EACH	\$ 56.20	\$ 66.10	\$ 16.35	\$ 20.40	\$ 26.90

Color/InStock Color: Natural White (148).

Poly Covers



CODE	1826CP FLAT LID	1218CP FLAT LID
DIMENSIONS	18" x 26"	12" x 18"
CASE LBS. (CUBE)	13.18 (0.93)	5.69 (0.43)
LIST PRICE EACH	\$ 20.85	\$ 12.55

Case Pack: 6

InStock Color: Natural White (148).

Camwear and Poly Lids are not interchangeable.

Accessories



CODE	1826DSCW	1218DSCW	1826CLRCW (5" DEEP)	18268CLRCW (8" DEEP)	18268CLRKIT
DESCRIPTION	Drain Shelf	Drain Shelf	Colander	Colander	ColanderKit™
DIMENSIONS	Fits 18" x 26" Food Storage Boxes	Fits 12" x 18" Food Storage Boxes	Fits Camwear Food Storage Boxes 18" x 26" x 6" and deeper	Fits Camwear Food Storage Boxes 18" x 26" x 9" and deeper	One 8" Deep Colander One 18" x 26" x 9" Food Box One 18" x 26" SlidingLid™
CASE PACK	6	6	6	4	1 Kit
CASE LBS. (CUBE)	10.91 (0.91)	3.75 (0.22)	28 (2.59)	24.25 (3.30)	16.71 (3.05)
LIST PRICE EACH	\$ 22.75	\$ 9.00	\$ 43.65	\$ 75.50	\$ 194.40

InStock Color: Clear (135).

CAMBRO FOOD PANS ARE AVAILABLE IN THE FOLLOWING MATERIALS



CAMWEAR® POLYCARBONATE FOOD PANS

- Store, transport and serve all in one pan.
- Virtually unbreakable polycarbonate won't crack, bend or dent.
- Crystal clear polycarbonate allows visibility for at a glance inventory management.
- Withstands temperatures from -40°F to 210°F (-40°C to 99°C).
- Lids protect contents and extend product freshness.
- Available in clear, black and white.



HEAT RESISTANT H-PANS™

- High heat material withstands extreme temperatures from -40°F to 375°F (-40°C to 190°C).
- Pans can go from prep to cooler to oven to steam table.
- Safe for use in microwaves, ovens and steam tables.
- Ideal for flash freezing, cooking and reheating.



TRANSLUCENT FOOD PANS

- An economical choice for storage and serving.
- Ideal for use on prep tables, food bars and vending carts.
- Translucent polypropylene is safe from -40°F to 160°F (-40°C to 70°C).
- Provides high chemical resistance.



COLDFEST® FOOD PANS

- Holds cold food at safe temperatures without ice for hours.
- Conforms to Gastronorm exterior dimensions to fit standard food bars or make tables.
- Stackable to save space when freezing and storing.
- Can be used for direct contact with all types of food products.





CAMWEAR® POLYCARBONATE FOOD PANS

Store, transport and serve all in one pan. Camwear food pans are made from durable polycarbonate that will not crack, bend or dent. Precisely designed to Gastronorm GN specifications, with a large radius bottom to reduce food waste. At half the cost of stainless steel, Camwear pans keep contents as cold as metal pans with less condensation. Pans stack neatly without wedging or sticking.

Colors: Clear (135), White (148), Black (110). Except 18CW and 28CW available in Clear (135) only.

Camwear pans are not recommended for steam table or microwave use. See H-Pan™ section for these high heat applications.

Colander Pan is covered by U.S. Patent D 528,376.

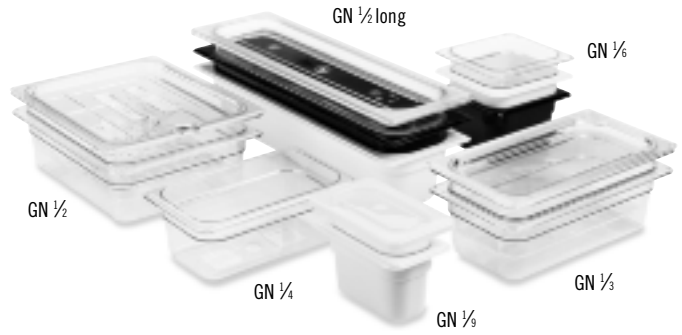

Uniform 1/2" (1.27 cm) flange ensures a smooth fit in prep tables and food bars.

Virtually unbreakable Camwear® polycarbonate withstands temperatures from -40°F to 210°F (-40°C to 99°C).

Molded-in graduations in standard & metric for easy inventory management.

Won't react with food; minimizes potentially hazardous chemical or acidic reaction.



Non-stick smooth interior surface increases yields and promotes easy cleaning.

Textured bottoms resist scratching.



Cold Test

Tests prove Camwear food pans keep products as cold as stainless steel. Stainless may feel colder, but as these test results demonstrate, Camwear food pans keep products just as cold for just as long.



CAMWEAR PANS

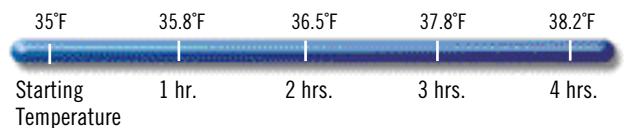

STAINLESS STEEL PANS

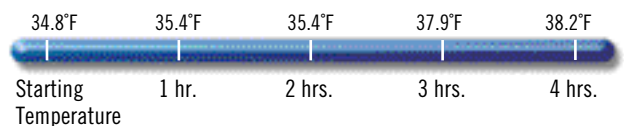

CAMWEAR® POLYCARBONATE FOOD PANS

FULL SIZE

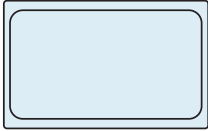

CONFIGURATIONS	PAN CODE	PAN DEPTH	APPROXIMATE CAPACITY QUART	CASE LBS. (CUBE)	LIST PRICE EA.
GN 1/2	12CW	2 1/2" (6,5 cm)	8.9	10.67 (1.30)	\$ 19.75
12 3/4" x 20 7/8" (32,5 x 53 cm)	14CW	4" (10 cm)	13.7	13 (1.67)	25.15
	16CW	6" (15 cm)	20.6	16.93 (2.09)	30.50
	18CW	8" (20 cm)	27.0	23 (2.78)	36.45
	10CWD	—	Drain Shelf	5.53 (0.35)	14.35

HALF SIZE LONG

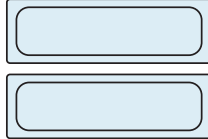

GN 1/2 Long	22LPCW	2 1/2" (6,5 cm)	3.2	5.65 (0.46)	15.00
6 3/8" x 20 7/8" (16,2 x 53 cm)	24LPCW	4" (10 cm)	5.3	7.72 (0.92)	18.70
	20LPCWD	—	Drain Shelf	1.92 (0.19)	7.45

HALF SIZE

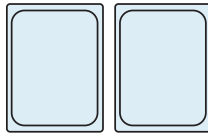

GN 1/2	22CW	2 1/2" (6,5 cm)	4.1	5.57 (0.69)	10.95
10 1/16" x 12 3/4" (26,5 x 32,5 cm)	24CW	4" (10 cm)	6.3	7.03 (0.87)	13.65
	26CW	6" (15 cm)	9.4	9.44 (1.12)	17.55
	28CW	8" (20 cm)	12.4	11.81 (1.36)	22.30
	20CWD	—	Drain Shelf	2.29 (0.17)	6.65

ONE THIRD SIZE

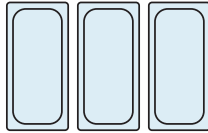

GN 1/3	32CW	2 1/2" (6,5 cm)	2.5	4.15 (0.46)	8.25
6 15/16" x 12 3/4" (17,6 x 32,5 cm)	34CW	4" (10 cm)	3.8	5.50 (0.57)	11.35
	36CW	6" (15 cm)	5.6	6.77 (0.74)	13.25
	38CW	8" (20 cm)	7.3	9 (0.94)	16.95
	30CWD	—	Drain Shelf	1.29 (0.07)	6.15

QUARTER SIZE

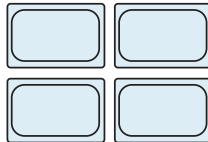

GN 1/4	42CW	2 1/2" (6,5 cm)	1.8	2.97 (0.32)	8.35
6 7/8" x 10 1/16" (16,2 x 26,5 cm)	44CW	4" (10 cm)	2.7	3.74 (0.44)	9.80
	46CW	6" (15 cm)	3.9	5.25 (0.58)	11.35
	40CWD	—	Drain Shelf	0.88 (0.06)	5.15

ONE SIXTH SIZE

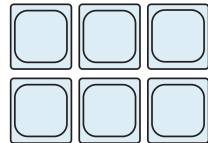

GN 1/6	62CW	2 1/2" (6,5 cm)	1.1	2.05 (0.24)	6.05
6 3/8" x 6 15/16" (16,2 x 17,6 cm)	64CW	4" (10 cm)	1.6	2.61 (0.32)	6.85
	66CW	6" (15 cm)	2.4	3.36 (0.40)	9.15
	60CWD	—	Drain Shelf	0.57 (0.05)	2.75

ONE NINTH SIZE



GN 1/9	92CW	2 1/2" (6,5 cm)	0.6	1.39 (0.16)	6.15
4 1/4" x 6 15/16" (10,8 x 17,6 cm)	94CW	4" (10 cm)	0.9	1.75 (0.20)	7.50
	90CWD	—	Drain Shelf	0.44 (0.04)	2.10

Case Pack for all Pans: 6. Lids listed on following page. InStock Color: Clear (135).



Colors: Clear (135), White (148), Black (110). 18CW, 28CW and Drain Shelves available in Clear (135) only.

All Camwear food pans are made of FDA approved materials. All Camwear food pans are designed to CEN Gastronorm Standard EN 631-1.



Drain Shelves

- Supports products and promotes drainage.
- Available to fit all pan sizes.



CAMWEAR® POLYCARBONATE COLANDER PANS



- Rinse, drain and store all in one pan.
- Liquids drain easily into the food pan below for enhanced food quality and reduced handling.
- Colanders simply lift out of the food pan for safe and quick disposal of liquids.
- Ideal for prepped produce, storing seafood on ice, and defrosting and storing meats and poultry.
- Camwear flat covers, covers with handles and notched covers with handles fit on pans with colanders.

Colander Pans are covered by U.S. Patent D569,169 S



13CLRCW



CONFIGURATIONS	PAN CODE	COLANDER DEPTH	FITS CAMWEAR PAN DEPTH*	CASE LBS. (CUBE)	LIST PRICE EA.
GN ½ 12¾" x 20¾" (32,5 x 53 cm)	 13CLRCW	3" (7,6 cm)	4" (10 cm)	10.75 (1.52)	\$ 25.15
	 15CLRCW	5" (12,7 cm)	6" (15 cm)	14.40 (2.0)	30.50
GN ½ 10⅞" x 12¾" (26,5 x 32,5 cm)	23CLRCW	3" (7,6 cm)	4" (10 cm)	5.0 (0.77)	13.65
	25CLRCW	5" (12,7 cm)	6" (15 cm)	7.80 (0.99)	17.55
GN ⅓ 6⅝" x 12¾" (17,6 x 32,5 cm)	33CLRCW	3" (7,6 cm)	4" (10 cm)	2.4 (0.53)	11.35
	35CLRCW	5" (12,7 cm)	6" (15 cm)	5.61 (0.69)	13.25
GN ¼ 6⅜" x 6⅝" (16,2 x 17,6 cm)	63CLRCW	3" (7,6 cm)	4" (10 cm)	2.25 (0.26)	6.85
	65CLRCW	5" (12,7 cm)	6" (15 cm)	3.09 (0.33)	9.15



Case Pack for all Pans: 6. Lids listed on following page. **InStock Color:** Clear (135).
*Fits this pan depth & deeper.

CAMWEAR® POLYCARBONATE LIDS

Flat Cover

Available in all pan sizes.



Cover with Handle

Deep molded handle provides secure grip. Also available in Black to help block light, reducing discoloration of meats and cheeses. Helps maintain freshness.



Notched Cover with Handle

Easy access for ladles or spoons.



Seal Cover

An economical option for light storage. Available in all pan sizes except half size long pans (22LPCW & 24LPCW).



FlipLid®

Flip up lid to easily access contents. Food can be held without getting dried out, increasing yields. Reduces points of cross contamination.



Notched FlipLid®

FlipLid with notch to rest spoon in contents with lid closed.



GripLid®

Molded-in polyurethane gasket on the lid grips the side of the food pan, reducing spills and points of cross-contamination.

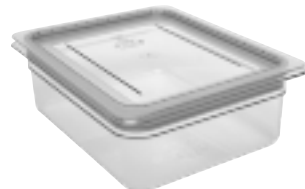

FITS PAN	LID CODE	DESCRIPTION	CASE LBS. (CUBE)	LIST PRICE EA.
GN 1/4	10CWC	Flat Cover	7.9 (0.43)	\$ 16.65
12 3/4" x 20 7/8" (32,5 x 53 cm)	10CWCH	Cover with Handle	8.48 (0.66)	16.65
	10CWCHN	Notched Cover w/Handle	8.47 (0.66)	16.65
	10CWGL	GripLid	10.68 (1.11)	36.15
	10SC	Seal Cover	6.56 (0.42)	10.80

GN 1/2 Long 6 3/8" x 20 7/8" (16,2 x 53 cm)	20LPCWC	Flat Cover	4.25 (0.24)	12.80
---	---------	------------	-------------	-------

GN 1/2	20CWC	Flat Cover	1.81 (0.22)	8.70
10 7/16" x 12 3/4" (26,5 x 32,5 cm)	20CWCH	Cover with Handle	3.83 (0.38)	8.70
	20CWCHN	Notched Cover w/Handle	3.88 (0.37)	10.20
	20CWL	FlipLid	5.40 (0.30)	13.75
	20CWLN	Notched FlipLid	5.40 (0.30)	13.75
	20CWGL	GripLid	5.73 (0.54)	25.10
	20SC	Seal Cover	2.96 (0.20)	6.25

GN 1/2	30CWC	Flat Cover	2.92 (0.13)	6.40
6 15/16" x 12 3/4" (17,6 x 32,5 cm)	30CWCH	Cover with Handle	3.15 (0.31)	6.40
	30CWCHN	Notched Cover w/Handle	3 (0.30)	8.70
	30CWL	FlipLid	3.64 (0.21)	11.75
	30CWLN	Notched FlipLid	3.76 (0.21)	11.75
	30CWGL	GripLid	4.35 (0.38)	17.30
	30SC	Seal Cover	1.81 (0.13)	4.60

GN 1/4	40CWC	Flat Cover	2 (0.11)	5.80
6 3/8" x 10 7/16" (16,2 x 26,5 cm)	40CWCH	Cover with Handle	2.03 (0.21)	5.80
	40CWCHN	Notched Cover w/Handle	2 (0.21)	5.80
	40SC	Seal Cover	1.55 (0.11)	4.15

GN 1/2	60CWC	Cover	1.22 (0.07)	4.55
6 3/8" x 6 15/16" (16,2 x 17,6 cm)	60CWCH	Cover with Handle	1.42 (0.15)	5.00
	60CWCHN	Notched Cover w/Handle	1.42 (0.16)	5.00
	60CWL	FlipLid	2 (0.11)	6.65
	60CWLN	Notched FlipLid	2 (0.11)	6.65
	60CWGL	GripLid	2.38 (0.21)	14.20
	60SC	Seal Cover	0.86 (0.08)	3.15

GN 1/4	90CWC	Flat Cover	0.83 (0.05)	5.10
4 1/4" x 6 15/16" (10,8 x 17,6 cm)	90CWCN	Flat Notched Cover	0.83 (0.05)	5.10
	90SC	Seal Cover	0.60 (0.05)	2.80

Case Pack for all Lids: 6

InStock Color: Clear (135).

Color: Clear (135).

Seal Cover Color: White (148).

Cover with Handle Colors: Clear (135), Black (110).

FlipLids are covered by U.S. Patent D 420,849, D 422,838 & D 427,012.
GripLids are covered by U.S. Patent D 446,076 & Utility Patent D 6,273,288 B1.



H-PANS™ HIGH HEAT FOOD PANS

Reduce handling and save expense with one pan that can go from prep to cooler to oven to steam table. H-Pans are designed to Gastronom GN specifications. Unlike metal pans, H-Pans are safe for use in microwave ovens. Also ideal for heated carts, steam tables and chafing dishes. H-Pans have both standard and metric graduation markings to promote easy inventory management.

Colors: Amber (150), Black (110).

H-Pans are made of FDA approved materials and are designed to CEN Gastronom Standard EN 631-1. Amber color may vary.



Uniform 1/2" (1,27 cm) flange ensures a smooth fit in prep tables and food bars.

Great for flash freezing, cooking and reheating.

Pans stack neatly, without wedging or sticking.

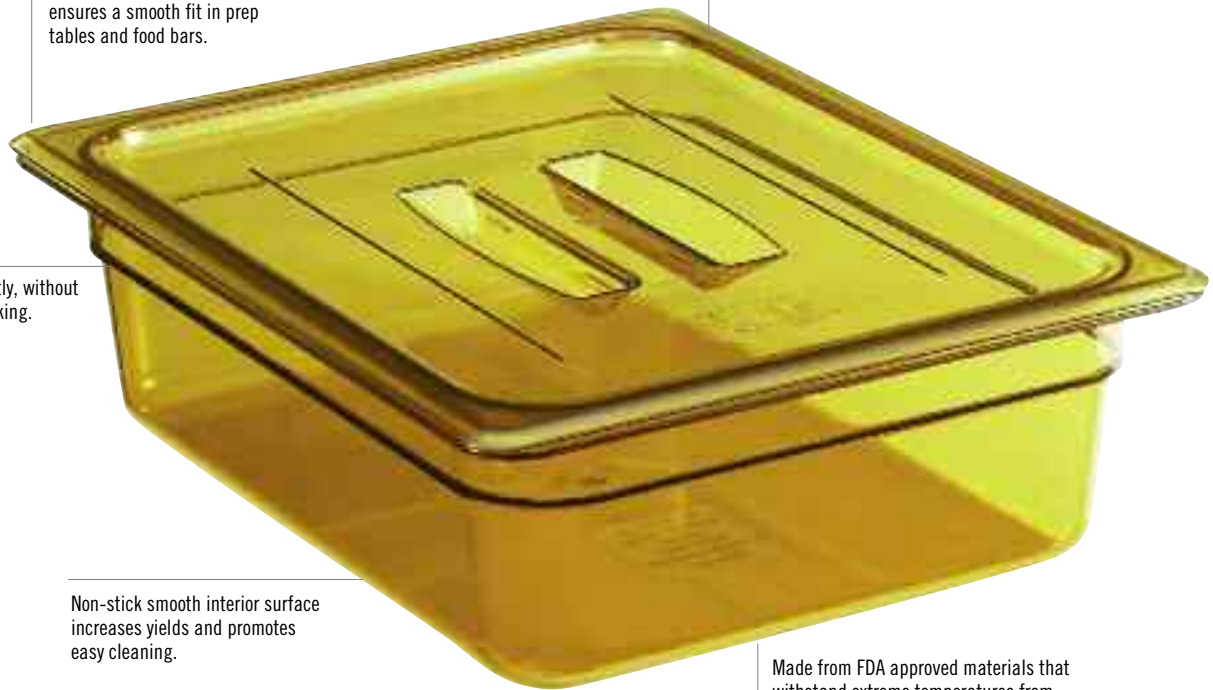

Non-stick smooth interior surface increases yields and promotes easy cleaning.

Made from FDA approved materials that withstand extreme temperatures from -40°F to 375°F (-40°C to 190°C).



H-PANS™ HIGH HEAT FOOD PANS

FULL SIZE

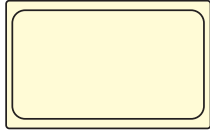

CONFIGURATIONS	PAN CODE	PAN DEPTH	APPROXIMATE CAPACITY	CASE LBS. (CUBE)	LIST PRICE EA.
GN 1/4	12HP	2 1/2" (6,5 cm)	8.9 qt.	10.87 (1.31)	\$ 48.75
12 3/4" x 20 7/8"	14HP	4" (10 cm)	13.7 qt.	14.24 (1.77)	58.95
(32,5 x 53 cm)	16HP	6" (15 cm)	20.6 qt.	19.50 (2.24)	76.65
	10HPD	—	Drain Shelf	5.72 (0.37)	32.25

HALF SIZE LONG

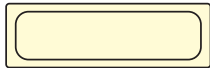
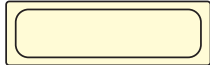

GN 1/2 Long	22LPHP	2 1/2" (6,5 cm)	3.2 qt.	5.83 (0.43)	34.65
6 3/8" x 20 7/8"	24LPHP	4" (10 cm)	5.3 qt.	8.63 (0.98)	43.10
(16,2 x 53 cm)	20LPHPD	—	Drain Shelf	1.92 (0.19)	16.10

HALF SIZE



GN 1/2	22HP	2 1/2" (6,5 cm)	4.1 qt.	5.96 (0.66)	24.30
10 7/16" x 12 3/4"	24HP	4" (10 cm)	6.3 qt.	8.40 (0.86)	31.60
(26,5 x 32,5 cm)	26HP	6" (15 cm)	9.4 qt.	10 (1.10)	40.50
	20HPD	—	Drain Shelf	2.44 (0.16)	14.45

ONE THIRD SIZE

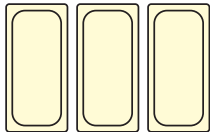

GN 3/8	32HP	2 1/2" (6,5 cm)	2.5 qt.	4.75 (0.45)	20.35
6 15/16" x 12 3/4"	34HP	4" (10 cm)	3.8 qt.	5.58 (0.59)	26.35
(17,6 x 32,5 cm)	36HP	6" (15 cm)	5.6 qt.	7.62 (0.75)	35.80
	30HPD	—	Drain Shelf	1.36 (0.09)	10.85

QUARTER SIZE



GN 1/4	42HP	2 1/2" (6,5 cm)	1.8 qt.	3.15 (0.34)	17.60
6 3/8" x 10 15/16"	44HP	4" (10 cm)	2.7 qt.	4 (0.44)	21.75
(16,2 x 26,5 cm)	46HP	6" (15 cm)	3.9 qt.	5.45 (0.58)	27.85
	40HPD	—	Drain Shelf	1 (0.06)	10.85

ONE SIXTH SIZE



GN 1/6	62HP	2 1/2" (6,5 cm)	1.1 qt.	2.85 (0.24)	13.75
6 3/8" x 6 15/16"	64HP	4" (10 cm)	1.6 qt.	3.01 (0.29)	16.60
(16,2 x 17,6 cm)	66HP	6" (15 cm)	2.4 qt.	3.81 (0.39)	20.15
	60HPD	—	Drain Shelf	0.60 (0.04)	5.60

ONE NINTH SIZE



GN 1/9	92HP	2 1/2" (6,5 cm)	0.6 qt.	1.45 (0.16)	10.40
4 1/4" x 6 15/16"	94HP	4" (10 cm)	0.9 qt.	1.85 (0.20)	12.15
(10,8 x 17,6 cm)	90HPD	—	Drain Shelf	0.45 (0.04)	4.15

Case Pack: 6. Lids listed on following page.

InStock Color: Amber (150).

Colors: Amber (150), Black (110).

Drain Shelf Color: Amber (150).

H-Pans are made of FDA approved materials and are designed to CEN Gastronorm Standard EN 631-1.

Amber color may vary.



Drain Shelf

- Supports product and promotes drainage.
- Available to fit all food pan sizes.



H-PAN™ COLANDER PANS

- Colanders drain liquids and grease away from hot foods, improving food quality
- Ideal for use in microwaves, steam tables and buffet lines.
- Reduces handling and improves food safety.
- H-Pan flat covers, covers with handles and notched covers with handles fit on pans with colanders.





Steam



Hold Hot Foods



Cook & Drain

CONFIGURATIONS	PAN CODE	COLANDER DEPTH	FITS H-PAN DEPTH*	CASE LBS. (CUBE)	LIST PRICE EA.
GN 1/2 12 3/4" x 20 7/8" (32,5 x 53 cm)	 13CLRHP	3" (7,6 cm)	4" (10 cm)	11.33 (1.52)	\$ 58.95
	 15CLRHP	5" (12,7 cm)	6" (15 cm)	15.15 (2.0)	76.65
GN 1/2 10 7/16" x 12 3/4" (26,5 x 32,5 cm)	23CLRHP	3" (7,6 cm)	4" (10 cm)	7 (0.83)	31.60
	25CLRHP	5" (12,7 cm)	6" (15 cm)	9.25 (1.06)	40.50
GN 1/3 6 15/16" x 12 3/4" (17,6 x 32,5 cm)	33CLRHP	3" (7,6 cm)	4" (10 cm)	4.58 (0.53)	26.35
	35CLRHP	5" (12,7 cm)	6" (15 cm)	6.2 (0.71)	35.80
GN 1/6 6 3/8" x 6 15/16" (16,2 x 17,6 cm)	63CLRHP	3" (7,6 cm)	4" (10 cm)	2.4 (0.29)	16.60
	65CLRHP	5" (12,7 cm)	6" (15 cm)	3.1 (0.34)	20.15

Case Pack for all Pans: 6. Lids listed on following page. **InStock Color:** Amber (150).
*Fits this pan depth & deeper.



H-PAN™ HIGH HEAT FOOD PAN LIDS

Flat Cover

Available in all pan sizes.



Cover with Handle

Deep molded handle gives secure grip.



Notched Cover with Handle

Easy access for ladles or spoons.



Seal Cover

An economical option for light storage. Available in all pan sizes except half size long pans (22LPHP & 24LPHP).



FlipLid®

Flip up lid to easily access contents. Food can be held without getting dried out, increasing yields.



Notched FlipLid®

FlipLid with notch to rest spoon in contents with lid closed.



FITS PAN	LID CODE	DESCRIPTION	CASE LBS. (CUBE)	LIST PRICE EA.
GN 1/2	10HPC	Flat Cover	9.4 (0.46)	\$ 43.75
12 3/4" x 20 7/8" (32,5 x 53 cm)	10HPCH	Cover with Handle	8.90 (0.66)	43.75
	10HPCHN	Notched Cover w/Handle	10 (0.64)	43.80
	10SC	Seal Cover	6.56 (0.42)	10.80
GN 1/2 Long 6 3/8" x 20 7/8" (16,2 x 53 cm)	20LPHPC	Flat Cover	4.50 (0.23)	26.10
GN 1/2	20HPC	Flat Cover	3.85 (0.21)	19.05
10 7/16" x 12 3/4" (26,5 x 32,5 cm)	20HPCH	Cover with Handle	4.54 (0.36)	20.20
	20HPCHN	Notched Cover w/Handle	4.13 (0.33)	23.15
	20HPL	FlipLid	5.49 (0.31)	33.49
	20HPLN	Notched FlipLid	5.86 (0.31)	33.49
	20SC	Seal Cover	3.25 (0.22)	6.25
GN 1/3	30HPC	Flat Cover	2.60 (0.14)	14.20
6 15/16" x 12 3/4" (17,6 x 32,5 cm)	30HPCH	Cover with Handle	2.89 (0.29)	16.05
	30HPCHN	Notched Cover w/Handle	2.88 (0.29)	16.05
	30HPL	FlipLid	4 (0.22)	23.94
	30HPLN	Notched FlipLid	3.88 (0.22)	23.94
	30SC	Seal Cover	1.81 (0.13)	4.60
GN 1/4	40HPC	Flat Cover	2 (0.10)	11.55
6 7/8" x 10 7/16" (16,2 x 26,5 cm)	40HPCH	Cover with Handle	2.22 (0.20)	12.40
	40HPCHN	Notched Cover w/Handle	2.22 (0.20)	12.60
	40SC	Seal Cover	1.55 (0.11)	4.15
GN 1/6	60HPC	Flat Cover	1.26 (0.08)	10.05
6 7/8" x 6 15/16" (16,2 x 17,6 cm)	60HPCH	Cover with Handle	1.42 (0.16)	10.05
	60HPCHN	Notched Cover w/Handle	1.5 (0.16)	10.05
	60HPL	FlipLid	2.26 (0.11)	13.70
	60HPLN	Notched FlipLid	2.04 (0.11)	13.70
	60SC	Seal Cover	0.86 (0.08)	3.15
GN 1/8	90HPC	Flat Cover	1.85 (0.05)	6.90
4 1/4" x 6 15/16" (10,8 x 17,6 cm)	90SC	Seal Cover	0.60 (0.05)	2.80

Case Pack for all Lids: 6

InStock Color: Amber (150).

Color: Amber (150).
Seal Cover Color: White (148).
Amber color may vary.

FlipLids are covered by U.S. Patent
D 420,849, D 422,838 & D 427,012 &
Patent 6,273,288 B1.



WE'VE GOT YOUR FOOD PANS COVERED!

Covers protect contents better than plastic wrap or foil while saving time and money. Lids improve food safety and extend product freshness.

Cover with Handle

Deep molded handle provides secure grip.

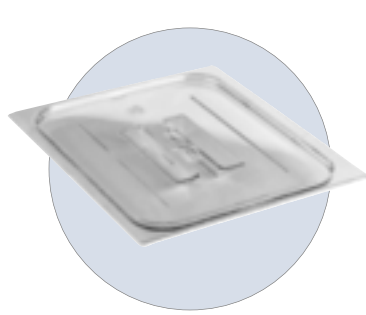

Seal Cover

Economical cover for all pan sizes.

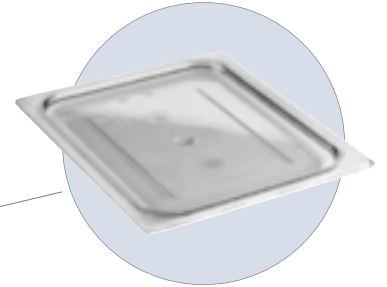

Flat Cover

Basic cover available in all pan sizes.

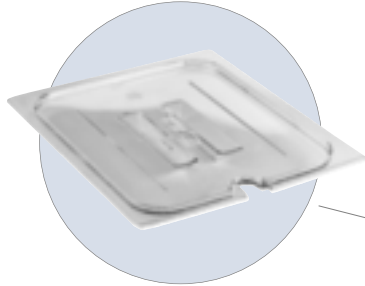

Notched Cover with Handle

Notched cover allows utensils to remain in pan and off of potentially contaminated counters.

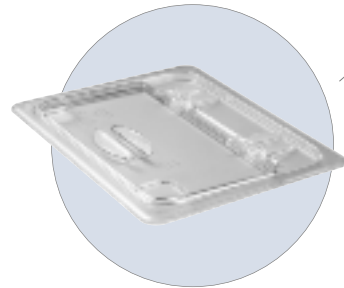

FlipLid®

Keeps contents covered yet flips up easily for service. Acts as an instant sneeze guard.

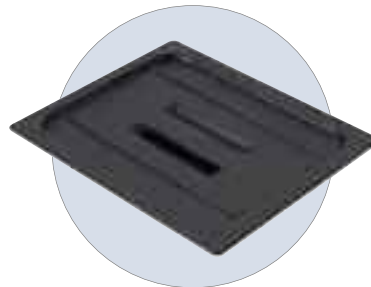

Black Cover with Handle

Available in black to block light, reducing discoloration of meats and cheeses.

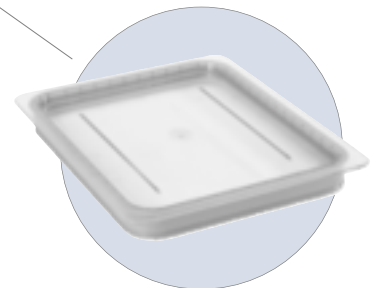

GripLid®

Lid "grips" the side of the pan, reducing spills and points of cross contamination.



SIZES

	GN 1/1	1/2	1/2 LONG	1/3	1/4	1/6	1/9
Flat Cover	•	•	•	•	•	•	•
Black Cover w/ Handle	•	•		•	•	•	
Cover w/ Handle	•	•		•	•	•	
Notched Cover w/ Handle	•	•		•	•	•	
Seal Cover	•	•		•	•	•	•
FlipLid®		•		•		•	
Notched Fliplid®		•		•		•	
GripLid®	•	•		•		•	

MATERIALS

	Camwear®	H-Pan™	Translucent
Flat Cover	•	•	•
Black Cover w/ Handle	•		
Cover w/ Handle	•	•	•
Notched Cover w/ Handle	•	•	•
Seal Cover	•	•	•
FlipLid®	•	•	
Notched Fliplid®	•	•	
GripLid®	•		

COLDVEST® GASTRONORM PANS, CROCKS, COVERS & PUMPS

- Keeps contents chilled at or below HACCP guidelines of 41°F (5°C) without the use of messy ice.
- Freeze for eight hours or overnight before filling with pre-chilled product.
- Half and third-size pans hold contents cold for up to eight hours. Sixth size pans and crocks hold contents cold for up to six hours.
- Conforms to Gastronorm exterior dimensions to fit standard food bars or make tables.
- Stackable to save space when freezing and storing.
- Can be used for direct food contact with all types of food products.

Colors: Black (110), White (148).

Flat Cover Color: Clear (135).

Seal Cover Color: White (148).

Pump with Cover Color: Clear (135).

Suggested holding times are based on tests with ambient room conditions of up to 74°F (23°C).

ColdFest is covered under U.S. Patent D 419,364.

*Pumps and Round Covers Not NSF Listed.



Ideal in Cambro Salad Bars or to chill condiments and creamers.

Pans / Crock



CODE	26CF	36CF	66CF	CFR18
CONFIGURATIONS	GN ½ – 10¼" x 12¾"	GN ⅓ – 6 ¹¹ / ₁₆ " x 12¾"	GN ⅙ – 6⅜" x 6¾"	Dia. 6 ¹³ / ₁₆ "
DEPTH	6"	6"	6"	6¼"
APPROX. CAPACITY	6.5 qt.	3.7 qt.	1.5 qt.	1.7 qt.
CASE LBS. (CUBE)	7.23 (0.52)	4.86 (0.34)	2.67 (0.18)	3 (0.20)
LIST PRICE EACH	\$ 55.60	\$ 41.80	\$ 28.45	\$ 30.85

Case Pack: 1

InStock Color: White (148).

Covers



CODE	20CFC	30CFC	60CFC	CFRC18*	CFRSC18
DESCRIPTION	Flat Cover	Flat Cover	Flat Cover	Flat Cover	Seal Cover
FITS COLDVEST	GN ½	GN ⅓	GN ⅙	Crock	Crock
CASE LBS. (CUBE)	1.50 (0.13)	1.03 (0.08)	0.50 (0.04)	0.45 (0.03)	0.25 (0.04)
LIST PRICE EACH	\$ 13.40	\$ 11.15	\$ 6.00	\$ 17.20	\$ 5.10

Case Pack: 2

InStock Color: Clear (135).

Pumps with Covers



CODE	CFPSRC10*	CFPMRC10*	CFPFR10*
DESCRIPTION	Standard Pump dispense 1oz. portions	Maxi Pump for chunky condiments	Fixed Nozzle Pump for controlled dispensing
DIMENSIONS W x D x H	7¼" x 9" x 11¼"	7¼" x 10¼" x 12½"	7¼" x 11½" x 11¾"
CASE LBS. (CUBE)	0.75 (0.11)	0.6 (0.11)	20.2 (0.11)
LIST PRICE EACH	\$ 15.15	\$ 36.05	\$ 35.70

Case Pack: 1



TRANSLUCENT FOOD PANS

- An economical choice for storing food.
- Translucent polypropylene material provides content visibility and high chemical resistance.
- Withstands temperature ranges from -40°F to 160°F (-40°C to 70°C).
- Meets Gastronorm GN food pan specifications.
- Non-stick smooth interior surface promotes easy cleaning.

Color: Translucent (190).

Graduation marks and capacities are approximate.

Full Size (GN ½) Translucent Food Pans are not designed for use in front loading carriers UPC400, UPCS400, UPC600, UPC800, UPC1200, UPC1600, UPCH400, UPCH800 Camtherm™ Carts or Combo Carts.

Translucent Food Pans are made of FDA approved materials. Designed to CEN Gastronorm Standard EN 631-1.

Translucent Food Pans interstack with other Cambro Food Pans.

Translucent Pans are not designed for steam table use.



UPC100 UPCS140 100MPC Ideal for transporting in Cambro top loading carriers.
 UPC140 UPCS160 240MPC
 UPC160



Translucent seal covers protect food quality while eliminating the expense of plastic wrap. Available for all translucent food pan sizes.



Uniform ½" (1,27 cm) flange width ensures the right fit in prep tables and food bars.



Use Cambro StoreSafe® food rotation labels on translucent food pans to manage inventory and reduce waste.

TRANSLUCENT FOOD PANS AND LIDS

FULL SIZE

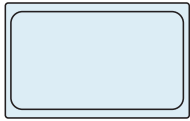

CONFIGURATIONS	PAN CODE	PAN DEPTH	APPROXIMATE CAPACITY	CASE LBS. (CUBE)	LIST PRICE EA.
GN 1/1	14PP	4" (10 cm)	13.7 qt.	8.75 (1.63)	\$ 14.70
12 3/4" x 20 7/8" (32,5 x 53 cm)	16PP	6" (15 cm)	20.6 qt.	12.52 (2.32)	18.75
	10PPD	—	Drain Shelf	4.18 (0.35)	8.35

HALF SIZE

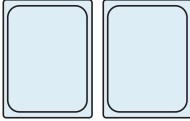

GN 1/2	24PP	4" (10 cm)	6.3 qt.	5.35 (0.85)	8.75
10 1/16" x 12 3/4" (26,5 x 32,5 cm)	26PP	6" (15 cm)	9.4 qt.	7.8 (1.10)	11.40
	20PPD	—	Drain Shelf	1.72 (0.16)	4.30

ONE THIRD SIZE

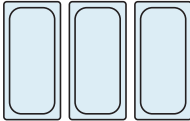

GN 1/3	34PP	4" (10 cm)	3.8 qt.	3.99 (0.98)	7.25
6 15/16" x 12 3/4" (17,6 x 32,5 cm)	36PP	6" (15 cm)	5.6 qt.	5 (0.76)	8.40
	30PPD	—	Drain Shelf	1.01 (0.08)	4.00

QUARTER SIZE



GN 1/4	44PP	4" (10 cm)	2.7 qt.	2.75 (0.45)	6.25
6 3/8" x 10 1/16" (16,2 x 26,5 cm)	46PP	6" (15 cm)	3.9 qt.	3.25 (0.52)	7.25
	40PPD	—	Drain Shelf	0.69 (0.06)	3.35

ONE SIXTH SIZE

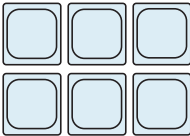

GN 1/6	64PP	4" (10 cm)	1.6 qt.	2.0 (0.29)	4.70
6 3/8" x 6 15/16" (16,2 x 17,6 cm)	66PP	6" (15 cm)	2.4 qt.	2.7 (0.39)	6.15
	60PPD	—	Drain Shelf	3.75 (0.03)	2.25

ONE NINTH SIZE



GN 1/9	94PP	4" (10 cm)	0.9 qt.	1.32 (0.2)	5.25
4 1/4" x 6 15/16" (10,8 x 17,6 cm)	90PPD	—	Drain Shelf	.37 (0.04)	1.55

Case Pack for all Pans: 6 InStock Color: Translucent (190).



1/1



1/3



1/4



1/6

FITS PAN	LID CODE	DESCRIPTION	CASE LBS. (CUBE)	LIST PRICE EA.
GN 1/1	10PPCH	Cover with Handle	6 (0.55)	\$ 10.85
12 3/4" x 20 7/8" (32,5 x 53 cm)	10PPSC	Seal Cover	6.47 (0.80)	10.85
GN 1/2	20PPCH	Cover with Handle	2.99 (0.36)	7.45
10 1/16" x 12 3/4" (26,5 x 32,5 cm)	20PPSC	Seal Cover	3.50 (0.40)	6.65
GN 1/3	30PPCH	Cover with Handle	2.15 (0.28)	5.15
6 15/16" x 12 3/4" (17,6 x 32,5 cm)	30PPCHN	Notched Cover w/Handle	2 (0.28)	6.35
	30PPSC	Seal Cover	2.25 (0.28)	5.90
GN 1/4	40PPCH	Cover with Handle	1.56 (0.20)	5.05
6 3/8" x 10 1/16" (16,2 x 26,5 cm)	40PPSC	Seal Cover	1.75 (0.20)	4.75
GN 1/6	60PPCH	Cover with Handle	1.62 (0.16)	4.35
6 3/8" x 6 15/16" (16,2 x 17,6 cm)	60PPCHN	Notched Cover w/Handle	1.07 (0.16)	4.75
	60PPSC	Seal Cover	1.18 (0.14)	4.35
GN 1/9	90PPC	Flat Cover	0.65 (0.05)	3.75
4 1/4" x 6 15/16" (10,8 x 17,6 cm)	90PPSC	Seal Cover	0.8 (0.10)	3.75

Case Pack for all Lids: 6 InStock Color: Translucent (190).

Color: Translucent (190).

All translucent food pans are made of FDA approved materials and are designed to CEN Gastronorm Standard EN 631-1.



Drain Shelf

Available for all food pan sizes.



Cover with Handle

Available for all food pan sizes except GN 1/9.



Notched Cover with Handle

Available for GN 1/3 and GN 1/6 food pans.



Seal Cover

Available for all food pan sizes.



Flat Cover

Only available for GN 1/9 food pans.

INGREDIENT BINS & CAMCRISPER®

Ingredient Bins

- Store bulk dry ingredients such as flour and grain.
- Hygienic clear sliding lid reduces handling and allows for quick content identification.
- Bin made of FDA-accepted material so no liners are needed.
- Designed to fit under standard work tables.

Camcrisper

- A self-contained system for storing, washing and transporting bulk produce.
- Prevents cross contamination and minimizes unnecessary handling.
- Transfer dry produce out of cartons into bin, cover and roll into cooler for safe storage.
- Wash and rinse produce for easy and safe prep.

3" Casters: 2 fixed, 2 swivel.

Bin Color: White (148).

Cover Color: Clear (135).

Scoops sold separately. S-Hook included.

*IBSF27 is not NSF listed.

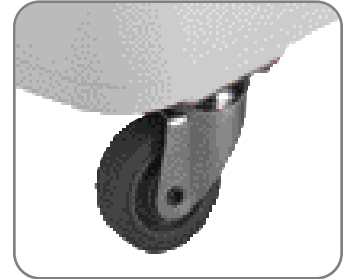

Casters feature wide wheels for excellent stability and weight bearing capability.



Now with Sliding Lid.



CODE	IBS20	IBS27	IBS37	IBSF27*
DIMENSIONS W x L x H	13" x 29½" x 28"	16⅝" x 29⅝" x 28"	21½" x 29½" x 28"	13" x 30⅝" x 28½"
CAPACITY	21 gal.	27 gal.	37 gal.	26.7 gal.
CUBIC FEET	2.87	3.98	5.55	3.56
LOAD CAPACITY (SUGAR)	170 lbs.	226 lbs.	314 lbs.	216 lbs.
LOAD CAPACITY (FLOUR)	140 lbs.	150 lbs.	225 lbs.	150 lbs.
CASE LBS. (CUBE)	28 (6.56)	31 (8.18)	28 (10.63)	28.5 (6.91)
LIST PRICE EACH	\$ 330.00	\$ 340.00	\$ 360.00	\$ 355.00

Case Pack: 1

InStock Color: White (148).



CODE	IB32	IB36	IB44	CC32 (Camcrisper)
DIMENSIONS W x L x H	22" x 24" x 23"	15¼" x 29½" x 29"	18½" x 29½" x 29"	22" x 24" x 23"
CAPACITY	32 gal.	34 gal.	42.5 gal.	32 gal.
CUBIC FEET	4.35	4.54	5.69	4.28
LOAD CAPACITY (SUGAR)	215 lbs.	252 lbs.	320 lbs.	24 lettuce heads (unfinished)
LOAD CAPACITY (FLOUR)	160 lbs.	180 lbs.	230 lbs.	42 lettuce heads (finished)
CASE LBS. (CUBE)	27.75 (7.5)	28.46 (7.64)	29.36 (9.31)	28.67 (7.67)
LIST PRICE EACH	\$ 350.00	\$ 360.00	\$ 365.00	\$ 520.00

Case Pack: 1

CAMWEAR® POLYCARBONATE SCOOPS & MEASURING CUPS

Camwear Scoops

- Virtually unbreakable Camwear polycarbonate will not dent, chip or rust.
- Molded-in sure grip handle includes a hole for hanging.
- Ideal for use with Cambro Ice Caddies and Ingredient Bins.

Color: Clear (135).



CODE	APPROXIMATE CAPACITY	CASE PACK	CASE LBS. (CUBE)	LIST PRICE EA.
SCP6CW	6 oz.	12	2.26 (0.20)	\$ 6.20
SCP12CW	12 oz.	12	2.90 (0.28)	6.70
SCP24CW	24 oz.	12	3.88 (0.43)	8.50
SCP64CW	64 oz.	6	4.15 (0.67)	12.15

InStock Color: Clear (135).

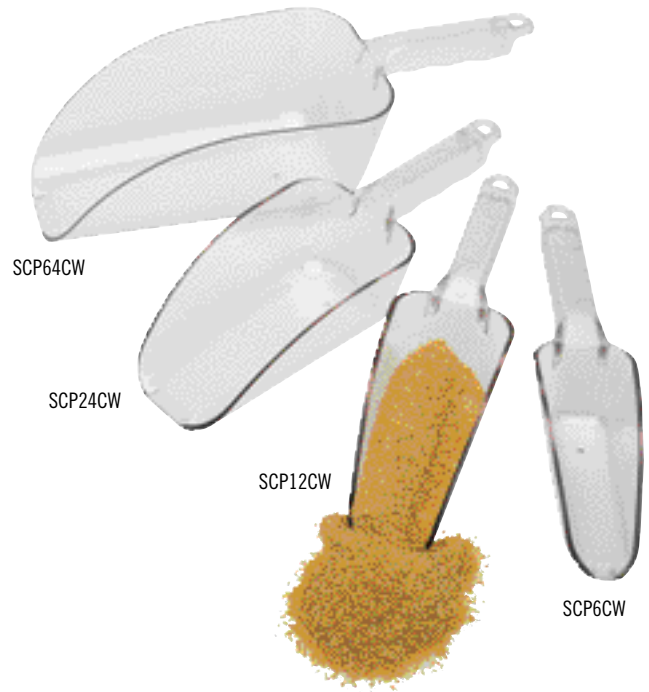

Camwear Measuring Cups

- Externally marked graduations are molded in and imprinted in red for American standard and blue for metric for easy measurement.
- Durable, virtually unbreakable Camwear polycarbonate will not dent, ensuring an accurate measurement every time.
- Molded-in handle will not break off.

Color: Clear (135).



CODE	CAPACITY	CASE PACK	CASE LBS. (CUBE)	LIST PRICE EA.
25MCCW	1 cup (dry measure)	12	1.75 (0.29)	\$ 6.05
50MCCW	1 pt.	12	4.79 (0.65)	11.30
100MCCW	1 qt.	12	6.75 (1.08)	12.70
200MCCW	2 qts.	12	10.60 (2.24)	17.50
400MCCW	4 qts.	1	1.56 (0.44)	19.00

InStock Color: Clear (135).



MERCHANDISING EQUIPMENT

CamKiosk® System

Work Station

Equipment Stand

Hand Sink Cart

Versa Organizers

Camcruiser® Vending Carts

Food Bars

Food Bar Accessories

Booster Seats

Portable CamBars®

Ice Caddies



CAMBRO
EQUIPMENT
DESIGNED FOR DURABILITY

Consultant Cut Sheets and
CAD drawings are available on
www.cambro.com

CAMKIOSK® SYSTEM – Every event or location is an opportunity for profits.

- Build sales off premise and in non-traditional locations.
- Two insulated food storage cabinets maintain safe hot or cold food and/or beverage temperatures for hours.
- Use Optional Well Covers to cover food pan wells and increase countertop space.
- Durable, all-weather polyethylene exterior with foam insulation will not crack, dent, bubble, chip, rust or break.
- Heavy duty 6" (15,2 cm) casters roll smoothly from kitchen to location then lock in place.



KVC854U Cart w/4 pan wells & umbrella.

CAMKIOSK® CARTS



Telescoping poles enable canopy to lower 12" for quick and easy storage.



Cart Colors Canopy Colors

	Navy Blue (186)		Beige (157)
	Hot Red (158)		
	Granite Gray (191)		Kentucky Green (519)
	Granite Green (192)		Beige/ Kentucky Green
	Kentucky Green (519)		
	Black Base with Granite Gray Top & Doors (426)		

Umbrella Color

Personalize your CamKiosk Cart to promote your brand.

Canopy Trim and Top Panel

(All Charges NET per side)

One Color	\$400.00
Two Color	460.00
Three Color	520.00

Front Display Panel

(Cruising Café panel standard)

Set Up Charge per Panel	\$135.00
Charge NET per Color	10.00

CODE	FULL SIZE PAN WELLS	OVERALL DIMENSIONS L x W x H	CASE LBS. (CUBE)	LIST PRICE EA.
CamKiosk Carts				
KVC854	4	85½" x 33½" x 70½"	302 (64.6)	\$ 6,545.00
KVC854C	4	85½" x 33½" x 94"	364 (90.899)	9,065.00
KVC854U	4	85½" x 60½" x 99"	345 (66.0)	6,995.00
KVC856	6	85½" x 33½" x 70½"	305 (64.6)	6,545.00
KVC856C	6	85½" x 33½" x 94"	349 (90.4)	9,065.00
KVC856U	6	85½" x 60½" x 99"	343.2 (72.54)	6,995.00

C: Canopy U: Umbrella

CODE	DESCRIPTION	DIMENSIONS L x W x H	CASE LBS. (CUBE)	CASE PACK	LIST PRICE EA.
Optional Accessories					
CB1220	Cutting Board	21" x 13½" x ½"	4 (0.31)	1	\$ 42.00
CP1210	Camchiller GN Half size	10¾" x 12¾" x 1½"	3.8 (0.18)	1	64.00
CP1220	Camchiller GN Full size	20¾" x 12¾" x 1½"	8.15 (0.32)	1	125.00
KMC24	Bridge Connector	32¼" x 23" x 38¾"	33.2 (5.52)	1	655.00
WCR1220	Well Cover	21" x 13" x 2"	5 (0.55)	1	94.00
1600DIV	ThermoBarrier® Insulated Shelf	20¾" x 13½" x 1½"	6.17 (0.55)	2	70.00

*Assembled dimensions for KMC24.



Conveniently located, lockable cash box (included) can also be kept in dry storage compartment.



Camchillers® keep packaged foods cold during transport and service. Place directly on top of food pan wells or at the top of the CamKiosk insulated holding cabinet.



Bridge connector joins CamKiosk and hand sink to create greater contiguous work space and under-counter storage.



4 well top with work space



6 well top

Holding Capacity Per Compartment

Two holding cabinets store hot or cold food in Gastronorm Food Pans with Covers.
 12 GN ½ full size 2½" deep pans or
 8 GN ½ full size 4" deep pans or
 6 GN ½ full size 6" deep pans or
 4 GN ½ full size 8" deep pans or
 4 each 2025 Camtrays or
 8 each 3253 Camtrays.

Bridge Connector & Well Cover Colors:

Black (110), Hot Red (158), Navy Blue (186), Kentucky Green (519), Granite Gray (191), Granite Green (192).

6" Casters: 2 fixed, 2 swivel, 2 with brake.

Cutting Board Color: White (148).

Camchiller Color: Cold Blue (159).

ThermoBarrier Color: Slate Blue (401).



Camchiller & ThermoBarrier



CAMKIOSK® HAND SINK CART, WORK STATION & EQUIPMENT STAND

Hand Sink Cart

- Self-contained, electric hand washing system can be used alone or with CamKiosk® Cart.
- Run hot and cold water for up to 70 hand washings.
- Includes: double stainless steel sinks, two 5-gallon (19 L) fresh water tanks, two 7½-gallon (28,5 L) waste-water bins, hand soap dispenser & paper roll holder.
- Durable polyethylene will not crack, dent, bubble, chip or break.
- Hand Sink Cart is designed for hand washing. It contains no filter for purifying water for drinking.

Colors: Granite Gray (191), Granite Green (192), Navy Blue (186), Hot Red (158), Green (519), Black Base with Granite Gray Top & Doors (426).

6" Casters: 2 fixed, 2 swivel, 2 with brake.

Hand Sink Cart is covered by U.S. Patent D 409,732 & by Patent D 6,173,458 B1.

† 220 volt model includes CEE7 type Euro plug.



Water pump only.

Hand Sink Water Pump, UL & CE approved.



Water heater and water pump draw a maximum of 11.25 amps and 0.7 amps, respectively. Hand Sink Cart electrical system runs on an average 10 amps.



ADA faucet available. Contact Cambro Customer Service for information.

CODE	VOLTAGE	DIMENSIONS L x W x H	CASE LBS. (CUBE)	LIST PRICE EA.
KSC402	110	40 ¹ / ₁₆ " x 32 ¹ / ₂ " x 45 ¹ / ₂ "	205.67 (39.41)	\$ 4,745.00
KSC402220†	220	40 ¹ / ₁₆ " x 32 ¹ / ₂ " x 45 ¹ / ₂ "	260 (40.6)	4,745.00

Case Pack: 1

Work Station

- Use to merchandise menu items or to complete sales transactions.
- Large dry storage cabinet below is perfect for holding supplies.
- Paper roll towel dispenser included.
- Extremely durable all-weather polyethylene will not crack, dent, bubble, chip, rust or break.

Colors: Granite Gray (191), Granite Green (192), Navy Blue (186), Hot Red (158), Green (519), Black Base with Granite Gray Top & Doors (426).

6" Casters: 2 fixed, 2 swivel, 2 with brake.

Top work area dimensions: 22¹/₂" x 26"



Work station shown with optional cutting board (CB1220).

CODE	DESCRIPTION	DIMENSIONS L x W x H	CASE LBS. (CUBE)	LIST PRICE EA.
KWS40	Work Station	40 ¹ / ₁₆ " x 32 ¹ / ₂ " x 45 ¹ / ₂ "	224 (40.6)	\$ 2,280.00
CB1220	Cutting Board	21" x 13 ¹ / ₈ " x 1/2"	4 (0.31)	42.00

Case Pack: 1

Equipment Stand

- Perfect for self-serve stations, prep areas or cash register service.
- If ordering with rails, choose low (ideal for children) or standard height rail placement.
- Counter and side openings for electrical cords and cables.
- Durable, lightweight polyethylene will not crack, dent, bubble, chip, rust or break.
- No assembly required.

Colors: Black (110), Slate Blue (401), Hot Red (158), Granite Gray (191), Granite Green (192), Navy Blue (186).

5" Casters: 2 fixed, 2 swivel with brake.

* Special order item not carried in stock – non-returnable.



Cutaway chair area gives ample space for comfortable seating.









CODE	DESCRIPTION	OVERALL DIMENSIONS W (W/TRAY RAILS) x D x H	CASE LBS. (CUBE)	LIST PRICE EA.
ES28	Stand only	28" x 28" x 39"	76 (19.15)	\$ 1,155.00
ES28R*	Stand w/Rail on right side of drawer	36" x 28" x 39"	83 (19.15)	1,350.00
ES28RS*	Stand w/Rail on right side of drawer – Low model	36" x 28" x 39"	83 (19.15)	1,360.00
ES28L*	Stand w/Rail on left side of drawer	36" x 28" x 39"	81.6 (19.15)	1,350.00
ES28LS*	Stand w/Rail on left side of drawer – Low model	36" x 28" x 39"	83 (19.15)	1,350.00
ES28RL*	Stand w/Rails on right and left sides of drawer	44" x 28" x 39"	85.33 (19.07)	1,540.00
ES28RLS*	Stand w/Rails on right and left sides of drawer – Low model	44" x 28" x 39"	85.33 (19.07)	1,540.00

Height includes casters.

CAMCRUISER® VENDING CARTS

- Add revenue opportunities away from the kitchen or cafeteria and reduce wait times.
- Durable polyethylene will not crack, dent, bubble, chip, rust or break.
- Display panel can be personalized with a custom logo or message.
- Larger models CVC724 & CVC72 have insulated food storage compartments and full-size food pan wells.
- The compact CVC55 has two open storage compartments, a single food pan well and cutting board.

Cart Color	Umbrella Color
Black (110)	
Hot Red (158)	
Navy Blue (186)	
Green (519)	
Granite Gray (191)	
Granite Green (192)	



CVC724
OPEN COMPARTMENT DIMENSIONS:
W 13 $\frac{1}{8}$ " x D 24 $\frac{1}{4}$ " x H 13 $\frac{1}{4}$ "
W 33,5 x D 61,5 x H 34 cm

CVC724 & CVC72



CVC724 has four full size food pan wells. Fill with cutting boards or well covers to create additional work space.



CVC72 One full size food pan well and two larger merchandising wells.



Open holding compartment conveniently stores cash box and tray.



Place one or two half size Camchillers directly on top of food pan well to hold cold packaged foods cold.



CVC72

CODE	CVC724	CVC72	CVC55
OVERALL DIMENSION*	L 74 $\frac{1}{2}$ " x W 31 $\frac{3}{4}$ " x H 94"	L 74 $\frac{1}{2}$ " x W 31 $\frac{3}{4}$ " x H 94"	L 55 $\frac{1}{16}$ " x W 31 $\frac{1}{4}$ " x H 93 $\frac{1}{2}$ "
WORK COUNTER HEIGHT	36 $\frac{1}{2}$ " (93 cm)	36 $\frac{1}{2}$ " (93 cm)	39 $\frac{3}{4}$ " (101 cm)
COUNTER WELLS HOLD	4 full size pans, 6" deep	Center well, 1 full size pan, 6" deep 2 outer wells, L 22 $\frac{1}{8}$ " x W 15 $\frac{3}{8}$ " x D 6"	1 full size pan, 6" deep
CLOSED COMPARTMENT CAPACITY (EACH)	2 full size 8" + 2 full size 2 $\frac{1}{2}$ " deep pans or 4 full size 6" deep pans or 6 full size 4" deep pans or 8 full size 2 $\frac{1}{2}$ " deep pans or 4 each 2025 Camtrays or 8 each 3253 Camtrays	2 full size 8" + 2 full size 2 $\frac{1}{2}$ " deep pans or 4 full size 6" deep pans or 6 full size 4" deep pans or 8 full size 2 $\frac{1}{2}$ " deep pans or 4 each 2025 Camtrays or 8 each 3253 Camtrays	—
OPEN COMPARTMENT CAPACITY	1 cash drawer and 1 full size 6" deep pan or 2 full size 4" deep pans or 3 full size 2 $\frac{1}{2}$ " deep pans	1 cash drawer and 1 full size 6" deep pan or 2 full size 4" deep pans or 3 full size 2 $\frac{1}{2}$ " deep pans	—
UMBRELLA DIAMETER	72" (183 cm)	72" (183 cm)	60" (152 cm)
CASTERS	8" – 4 swivel with brake	8" – 4 swivel with brake	6" – 2 fixed, 2 swivel with brake
CASH DRAWER	Yes	Yes	—
MENU BOARD	Yes	Yes	—
DISPLAY PANEL	Yes	Yes	Yes
MOLDED IN HANDLES	2	2	1
CASE LBS. (CUBE)	265.6 (74.42)	283 (76.59)	167.65 (45.65)
LIST PRICE EACH	\$ 5,350.00	\$ 5,350.00	\$ 3,210.00

*Includes Umbrella. Serving counter height is 51".

CAMCRUISER® VENDING CARTS



CVC55

Unit ships with umbrella and cutting board.
Front display panel can be personalized.

Cutting Board Color: White (148).
Camchiller Color: Cold Blue (159).
Divider Bar Colors: White (148),
Clear (135).
Retainer Strap Color: Black (110).
ThermoBarrier Color: Slate Blue (401).

Well Cover Color matches cart.

CVC55 is covered by U.S. Patent
D 362,102.



Pizza Camcruiser



Sandwich Camcruiser



Hot Dog Camcruiser



Soft Drink Camcruiser

Compartments are open for storage and easy access to equipment and supplies for your vending operations. Optional retainer strap is sold separately.

LEFT COMPARTMENT DIMENSIONS:
W 24¼" x D 28½" x H 27½"

RIGHT COMPARTMENT DIMENSIONS:
W 21½" x D 28½" x H 27½"

CVC55



Set up with full and fractional size food pans and divider bars to increase product offerings.



Electrical or soda line conveniently drops through 4" x 6¾" opening in counter.
Cover is standard with cart.

CODE	DESCRIPTION	FITS	OVERALL DIMENSIONS L x W x H	CASE LBS. (CUBE)	LIST PRICE EA.
Optional Accessories					
CB1220	Cutting Board	CVC724, CVC72, CVC55	21" x 13½" x ½"	4 (0.31)	\$ 42.00
CP1220	Full GN Camchiller®	CVC724, CVC72	20 ¹³ / ₁₆ " x 12 ⁷ / ₈ " x 1½"	8.15 (0.32)	125.00
CP1210	½ GN Camchiller	CVC724, CVC72	10 ³ / ₈ " x 12 ³ / ₄ " x 1½"	3.8 (0.18)	64.00
DIV12	Divider Bar	CVC724, CVC72, CVC55	Well Only	.05 (0.02)	3.70
WCR1220	Well Cover	CVC724, CVC72, CVC55	21" x 13" x 2"	5 (0.55)	94.00
730STP	Retainer Strap	CVC55	—	1 (0.05)	26.00

DIV12 Case Pack: 3 - 1600DIV Case Pack: 2 - All Others Case Pack: 1 Camchiller, ThermoBarrier & Divider Bar are NSF listed.

Personalize your Camcruiser Cart to promote your brand.

Front Display Panel

"Campus Cuisine" display panel standard on CVC724 & CVC72.
Striped panel standard on CVC55.

Set Up Charge per Panel \$135.00 (Net)

Charge per Color 10.00 (Net)

BOOSTER SEATS & VERSA ORGANIZERS

Booster Seats

- Contoured seat, high sides, wide square base and non-skid surface for toddler comfort and safety.
- Choose from dual or single seat models, with or without strap.
- Durable polyethylene will not crack, dent, bubble, chip, rust or break.

Colors: Black (110), Dark Brown (131), Coffee Beige (157), Brick Red (402), Navy Blue (186), Green (519), Hot Red (158), Granite Green (192).

No broken cartons on 4 pack.



Booster seats are available with or without straps.



Single Seat



Dual Seat

Dimensions	
Overall	11 $\frac{1}{2}$ " W x 11 $\frac{1}{4}$ " D x 8 $\frac{1}{2}$ " H
Seat Base	8 $\frac{1}{4}$ " W x 9 $\frac{3}{4}$ " D
Inside Seat	9 $\frac{1}{2}$ " W x 9 $\frac{3}{4}$ " D x 4 $\frac{3}{8}$ " H

Dimensions	
Overall	12 $\frac{1}{6}$ " W x 12 $\frac{1}{4}$ " D x 9 $\frac{1}{2}$ " H
Seat Base A	12 $\frac{1}{6}$ " W x 12 $\frac{1}{4}$ " D
Seat Base B	12 $\frac{1}{6}$ " W x 12 $\frac{1}{6}$ " D
Inside Seat A	8 $\frac{1}{4}$ " W x 9 $\frac{1}{2}$ " D x 3 $\frac{1}{4}$ " H
Inside Seat B	10 $\frac{1}{4}$ " W x 10 $\frac{1}{4}$ " D x 4 $\frac{1}{4}$ " H

CODE	100BC	100BC1	100BCS
Single Seat			
DESCRIPTION	no strap	no strap	with strap
CASE PACK	4	1	4
CASE LBS. (CUBE)	9.8 (2.11)	2.82 (0.67)	12.2 (2.08)
LIST PRICE EACH	\$ 38.00	\$ 42.00	\$ 55.00
CODE	200BC	200BC1	200BCS
Dual Seat			
DESCRIPTION	no strap	no strap	with strap
CASE PACK	4	1	4
CASE LBS. (CUBE)	17 (3.76)	4.4 (0.99)	16.8 (3.76)
LIST PRICE EACH	\$ 49.00	\$ 53.00	\$ 66.00

Versa Organizers

- Use to store non-perishable condiments, disposable ware and napkins.
- Hold bins in 2 x 3, 2 x 4, 3 x 3, or 3 x 4 arrangements.
- Made of seamless, one-piece polyethylene.
- Set on flat surface or wall mount each bin holds up to 10 lbs. (4,5 Kg).
- Easy to assemble and easy to clean.

Bins Only

Colors: Coffee Beige (157), Dark Brown (131), Black (110), Slate Blue (401), Speckled Gray (480).

Versa Line Combined Pack Bins & Racks

Colors: Dark Brown (131), Black (110), Speckled Gray (480).



12RS12 Versa Organizer shown mounted on wall.



Bins sold separately (5412CBP) or as combined packs.



8RS8



6RS6

CODE	DESCRIPTION	PRODUCT DIMENSIONS	CASE PACK	CASE LBS. (CUBE)	LIST PRICE EA.
Bins		W x D x H			
5412CBP		5" x 12" x 4 $\frac{1}{4}$ "	12	7.84 (1.78)	\$ 8.40
Versa Line Combined Pack		L x D x H (complete unit)			
12RS12	Rack w/12 bins	25 $\frac{1}{8}$ " x 21 $\frac{3}{8}$ " x 14 $\frac{1}{4}$ "	1	14.77 (3.29)	172.00
9RS9	Rack w/9 bins	20 $\frac{1}{8}$ " x 21 $\frac{3}{8}$ " x 14 $\frac{1}{4}$ "	1	11.76 (2.65)	152.00
8RS8	Rack w/8 bins	25 $\frac{1}{8}$ " x 17 $\frac{1}{4}$ " x 9 $\frac{1}{4}$ "	1	9.81 (2.33)	139.00
6RS6	Rack w/6 bins	20 $\frac{1}{8}$ " x 17 $\frac{1}{4}$ " x 9 $\frac{1}{4}$ "	1	7.84 (1.64)	125.00

FREE STANDING FOOD BARS

Food Bars

- Reduce wait times with extra food stations and enhance menus with fresh food selections.
- Durable, lightweight polyethylene will not crack, dent, bubble, chip, rust or break.

Ultra Bars

- Feature a protected storage cabinet below for extra trays and supplies.
- Sliding doors on both sides provide easy access to storage area.



Shown with optional End Tables, Tray Rails, Crock and Salad Bowl Holders.

Ultra Bars: 6UBR, 5UBR, 4UBR
End Table Height: 33¾" **Tray Rail Height:** 34½"
5" Casters: 4 swivel with brake



Shown with optional End Tables and Tray Rails.

Floor Models: 6FBR, 5FBR, 4FBR
End Table Height: 33¾" **Tray Rail Height:** 34½"
5" Casters: 4 swivel with brake



Floor Models

- Portable and lightweight model for showcasing menu selection.
- Faucet drains melted ice into a pail or attaches to a hose for added convenience.

Children's Food Bars

- The tray rail is set at 27½" (70 cm) from the floor, perfect for young children serving themselves.
- Perfect for elementary schools and family dining.



Shown with optional End Tables and Tray Rails.

Children's Food Bars: 6FBRSL, 5FBRSL, 4FBRSL
End Table Height: 27" **Tray Rail Height:** 27½"
5" Casters: 4 swivel with brake



TABLE TOP FOOD BARS & BUFFET BARS

Table Top Food Bars

- Turn a 4'-6' (130-182 cm) table into a double-sided self service buffet or beverage station.
- Thick, foam-insulated ice well holds ice for hours.
- Drain plug allows quick and easy clean-up.



4FBRTT Table Top Food Bar



BUF48 Buffet Bar Base

Merchandises soft drinks on ice to increase beverage sales.

Buffet Bars

- Ideal for holding snacks and cold beverages.
- The Buffet Bar with Sneeze Guard is perfect for single-sided, self-serve buffets.



FSG480 Sneeze Guard

The Free Standing Sneeze Guard is the perfect showcase for salad or dessert items.



BBR480 Buffet Bar with Sneeze Guard

End Tables and Tray Rails

- Add tray rails or end tables on food bars to expand service area and offer convenience to customers.
- The optional end table easily mounts on either end.



Food Bar shown with no end table.



Floor Model Food Bar shown with End Table on both sides and Tray Rail in front.



FBRTBL, End Table down.



ColdFest® Pans

ColdFest pans fit perfectly in Cambro Food Bars and keep foods chilled at or below HACCP guidelines of +41°F (+4°C) for up to 8 hours without ice. See ColdFest Food Pans in Food Pan section.

FOOD BAR ACCESSORIES – For Extra Convenience

Every Accessory You Need

- Crock and Salad Bowl Holders to highlight and organize salads, condiments and dressings.
- Tray Rails offer convenience for your patrons.
- Divider Bars securely hold Food Pans in place, providing greater flexibility.

See Camwear® Food Pans and Crocks section for more information.



5 ft. Food Bar shown with fractional sizes of Food Pans and Divider Bars.



5 ft. Food Bar shown with Salad Bowl Holder, SBH18 and 2 each Crock Holders, CPH3.

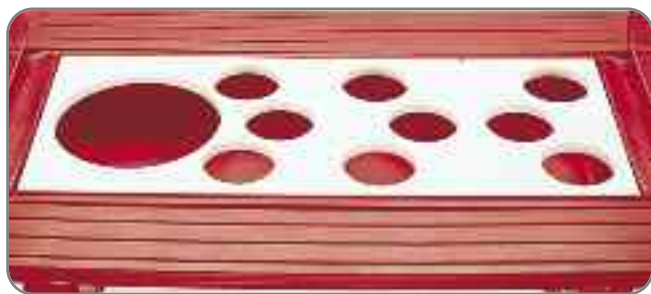

5 ft. Food Bar shown with Salad Bowl Holder, SBH15 and 2 each Crock Holders, CPH3.

Size Guide for Food Bars using Food Pans with Divider Bars, Salad Bowl and Crock Holders.

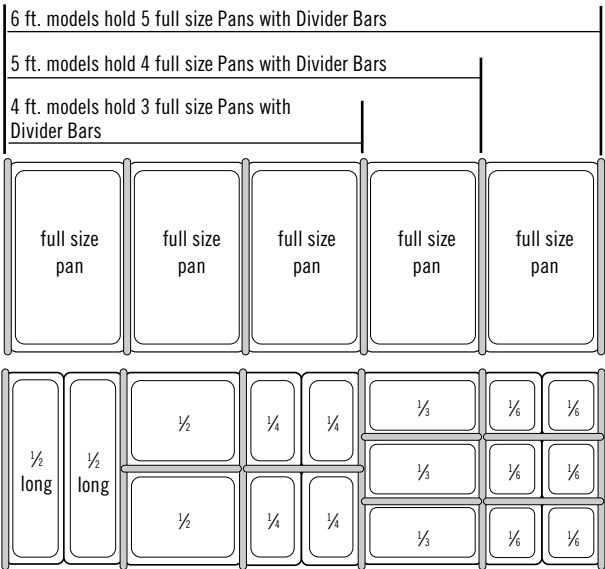

Fractional Size Pans can be used in many variations with Divider Bars. Mix and match sizes to fit your needs.

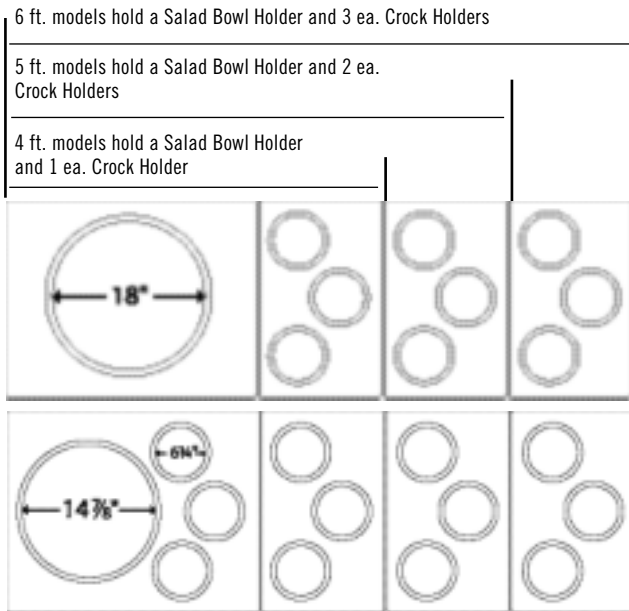

Two Salad Bowl Holder models available, SBH18 and SBH15. Crock Holder, CPH3, holds 1.5 and 2.7 qt. crocks.

FOOD BAR ACCESSORIES SIZES, PRICES & ORDERING INFORMATION

DESCRIPTION	CODE	OVERALL EXTERIOR DIMENSIONS	FULL SIZE PAN CAPACITY	WELL INTERIOR DIMENSIONS	CASE PACK	CASE LBS. (CUBE)	LIST PRICE EA.
Ultra Food Bars with Cabinet Base		L x W x H		L x W x D			
	6UBR	71½" x 32¾" x 52½"	5	62⅞" x 20⅞" x 6½"	1	160 (42.15)	\$ 2,110.00
	5UBR	63⅞" x 33¼" x 52½"	4	50⅞" x 20⅞" x 6½"	1	161 (39.50)	1,960.00
	4UBR	51" x 33¼" x 52½"	3	37¼" x 20⅞" x 6½"	1	143 (39.50)	1,855.00
Floor Model Food Bars		L x W x H		L x W x D			
	6FBR	71½" x 33¼" x 52½"	5	62⅞" x 20⅞" x 6½"	1	59.8 (27.46)	1,825.00
	5FBR	63⅞" x 33¼" x 52½"	4	50⅞" x 20⅞" x 6½"	1	134 (25.82)	1,770.00
	4FBR	51" x 33¼" x 52½"	3	37¼" x 20⅞" x 6½"	1	67 (25.83)	1,670.00
Children's Food Bars		L x W x H		L x W x D			
	6FBRSL	71⅞" x 32¾" x 45¼"	5	62⅞" x 20⅞" x 6½"	1	136 (27.24)	1,825.00
	5FBRSL	63⅞" x 32¾" x 45¼"	4	50⅞" x 20⅞" x 6½"	1	124.67 (25.13)	1,765.00
	4FBRSL	51" x 32¾" x 45¼"	3	37¼" x 20⅞" x 6½"	1	116 (25.62)	1,665.00
Table Top Model Food Bars		L x W x H		L x W x D			
	6FBRTT	71½" x 33¼" x 27"	5	62⅞" x 20⅞" x 6½"	1	111 (17.57)	1,330.00
	5FBRTT	63⅞" x 33¼" x 27"	4	50⅞" x 20⅞" x 6½"	1	98 (16.26)	1,225.00
	4FBRTT	51" x 33¼" x 27"	3	37¼" x 20⅞" x 6½"	1	85 (16.26)	1,115.00
Buffet Bars		L x W x H		L x W x D			
	BUF72	67½" x 24" x 7"	5	62⅞" x 20⅞" x 5"	1	28 (6.62)	435.00
	BUF48	41⅜" x 24" x 7"	3	37⅝" x 20⅞" x 5"	1	21 (3.80)	375.00
Free Standing Sneeze Guards		L x W x H		L x W			
	FSG720	73⅞" x 16½" x 24⅞"		67½" x 15¼"	1	33.50 (6.80)	425.00
	FSG480	48" x 16½" x 24½"		42" x 15¼"	1	25 (4.30)	335.00
Buffet Bars w/Sneeze Guard		L x W x H		L x W x D			
	BBR720	73⅞" x 24⅞" x 24½"	5	62⅞" x 20⅞" x 5"	1	67 (20.74)	840.00
	BBR480	48" x 24⅞" x 24½"	3	37⅝" x 20⅞" x 5"	1	50 (10.88)	705.00
OPTIONAL ACCESSORIES							
Tray Rails		L x W x D		Height from floor (except Children Food Bar Models)			
	FBR6R (6 ft.)	70" x 8" x 1½"		34¾"	1	15 (1.45)	355.00
	FBR5R (5 ft.)	63½" x 8" x 1½"		34¾"	1	14.25 (1.19)	340.00
	FBR4R (4 ft.)	50¼" x 8" x 1½"		34¾"	1	13.75 (1.02)	335.00
End Table		L x W x D		Holding capacity			
	FBRTBL	16¼" x 21" x 4¾"		50 lbs.	1	9.59 (1.05)	360.00
Divider Bars		Length					
	DIV12	12¾"			3	0.5 (0.02)	3.70
	DIV20	20⅞"			3	3.1 (0.10)	8.85
Crock Holder		L x W		Holding capacity			
	CPH3	12⅞" x 20⅞"		1.5 & 2.7 qt.	1	2.2 (0.29)	60.00
Salad Bowl Holders		L x W					
	SBH15	25¾" x 20⅞"	(holds a 15" bowl and 3 crocks)		1	4.50 (0.66)	61.00
	SBH18	25¾" x 20⅞"	(holds an 18" bowl)		1	4.50 (0.66)	61.00

InStock Color: Black (110), Green (519).

Food Bar Colors: Black (110), Slate Blue (401), Navy Blue (186), Green (519), Hot Red (158), Granite Gray (191), Granite Green (192).
Divider Bar Colors: White (148), Clear (135).

Crock Holder and Salad Bowl Holders available in White (148) only.

Food Bar with upright & modular support system is Covered by U.S. Patent D 364,764.

Sneeze guard, Salad Bowl Holders & Crock Holders are covered by U.S. Patent D 5,551,774.

Divider Bars are covered by U.S. Patent D 366,581.

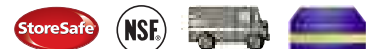

BUF48, FSG480 and all accessories can be shipped by parcel carrier.



PORTABLE CAMBARS®



- Stylish, portable beverage bars for hosting in any environment.
- Select from three systems: economy for bottle and can service, partial or complete soda gun set up systems for pre-mix (canisters) or post-mix (bag-in-box).
- Choose between three sizes.
- Large BAR730 is perfect for banquets and cocktail events.
- Mid-size BAR650 fits into standard elevators and is ideal for small to mid-size functions.
- Small BAR540 is ultra portable for off-premise use and events with limited space.
- All models include speed rail and 80-pound capacity ice sink with cover.*
- Impact-resistant, waterproof polyethylene will not crack, dent, bubble, chip, rust or break.
- Lightweight and portable.
- Easy to take apart and clean, easy to set up.

*BAR540 sink comes uncovered.



THREE SIZES

THREE SYSTEMS

	ECONOMY SYSTEM	BASIC SYSTEM	COMPLETE SYSTEM
<p>Large BAR730 Models</p> 	<ul style="list-style-type: none"> • For Bottle, Can, or Mixer Service • Includes Ice Bin & Speed Rail • Standard or Designer Decor 	<ul style="list-style-type: none"> • Partially Equipped for Post or Pre-Mix Soda Service • Operator Completes Installation • Standard or Designer Decor 	<ul style="list-style-type: none"> • Completely Factory Equipped for Post or Pre-Mix Soda Service • Standard or Designer Decor
<p>Standard Decor BAR730</p> <p>Designer Decor BAR730DS</p>	<p>Standard Decor BAR730CP</p> <p>Designer Decor BAR730DSCP</p>	<p>Standard Decor BAR730PM, BAR730PMT, BAR730PMT220, BAR730DX</p> <p>Designer Decor BAR730DSPM, BAR730DSPMT, BAR730DSPMT2, BAR730SDX</p>	
<p>Mid-Size BAR650 Models</p> 	<ul style="list-style-type: none"> • For Bottle, Can, or Mixer Service • Includes Ice Bin & Speed Rail • Standard or Designer Decor 	<ul style="list-style-type: none"> • Partially Equipped for Post or Pre-Mix Soda Service • Operator Completes Installation • Standard or Designer Decor 	<ul style="list-style-type: none"> • Completely Factory Equipped for Post or Pre-Mix Soda Service • Standard or Designer Decor
<p>Standard Decor BAR650</p> <p>Designer Decor BAR650DS</p>	<p>Standard Decor BAR650CP</p> <p>Designer Decor BAR650DSCP</p>	<p>Standard Decor BAR650PM, BAR650PMT, BAR650PMT220, BAR650DX</p> <p>Designer Decor BAR650DSPM, BAR650DSPMT, BAR650DSPMT2, BAR650SDX</p>	
<p>Small BAR540 Models</p> 	<p>Standard Decor BAR540</p> <p>Designer Decor BAR540DS</p>	N/A	N/A

PORTABLE CAMBARS®

Standard Equipment, Soda Guns, Standard Colors and Designer Decor Packages

STANDARD DECOR EQUIPMENT DESIGNER DECOR EQUIPMENT	ECONOMY			BASIC SYSTEM		COMPLETE SYSTEM POST-MIX (Bag in Box)				COMPLETE SYSTEM PRE-MIX (Canisters)	
	BAR540 BAR540DS	BAR650 BAR650DS	BAR730 BAR730DS	BAR650CP BAR650DSCP	BAR730CP BAR730DSCP	BAR650PM BAR650SPM	BAR650PMT BAR650DSPMT	BAR730PM BAR730DSM	BAR730PMT BAR730DSPMT	BAR650DX BAR650SDX	BAR730DX BAR730SDX
Bag In Box Syrup Pumps						3	3	6	6		
Bag In Box Rack (Holds 3 Boxes)						1	1	2	2		
Carbonator						YES	YES	YES	YES		
CO ₂ Regulator						YES	YES	YES	YES	YES	YES
CO ₂ Clamp & Chain				YES	YES	YES	YES	YES	YES	YES	YES
8 - Circuit Cold Plate				YES	YES	YES	YES	YES	YES	YES	YES
Ice Sink and Cover	Sink Only	YES	YES	YES	YES	YES	YES	YES	YES	YES	YES
Retainer Strap		1	2	1	2	1	1	2	2	1	2
Soda Gun (5, 6 or 8 buttons)						5	5	8	8	5	6
Speed Rail (5 or 7 bottle)	5	7	7	7	7	7	7	7	7	7	7
Water Pump							YES		YES		
Water Tank							YES		YES		
Water Line Hook Up (city source)						YES		YES			
Waste Water Bin		YES	YES	YES	YES	YES	YES	YES	YES	YES	YES
Vinyl Cover	YES	YES	YES	YES	YES	YES	YES	YES	YES	YES	YES

Casters: All BAR540 Models - Four 5" swivel, two with brake. All BAR650 and BAR730 Models - Four 6" swivel, two with brake.

Soda Guns by Wunder-Bar®

- Fast, low foaming delivery
- Two year warranty from Wunder-Bar®
- Includes holster with overflow drain
- Available with complete systems only



Post-Mix 8 Button
(BAR730 Complete System)



Post-Mix 5 Button
(BAR650 Complete System)



Pre-Mix 6 Button
(BAR730 Complete System)



Pre-Mix 5 Button
(BAR650 Complete System)

Standard and Designer Decor Packages

Standard Decor BAR540, BAR650, BAR730



Black (110)



Granite Gray (191)

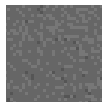

Granite Sand (194)

BAR650, BAR730 Only



Two-Tone Brown
Mahogany (189)



Granite Gray w/
Black Base (420)



Granite Green w/
Black Base (421)

BAR540 Only



Dark Brown (131)



Coffee Beige (157)



Slate Blue (401)

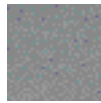

Gray (180)

BAR730 & BAR650 Speed Rail Colors: Black (110), Gray Marble (188), Brown Mahogany (189), Granite Gray (191), Granite Sand (194).

BAR540 Speed Rail Colors: Dark Brown (131), Coffee Beige (157), Black (110), Slate Blue (401), Gray (180), Granite Gray (191).

Designer Decor BAR540 Only



Black Base w/ Coal
Counter (670)



Granite Gray Base w/
Slate Gray (671)



Granite Sand Base w/
Cocoa Counter (672)

BAR650, BAR730 Only



Manhattan (667)

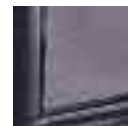

Chicago (770)

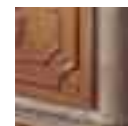

Sedona (668)



Carmel (669)

Optional Accessories for CamBars

CODE	DESCRIPTION	CASE LBS. (CUBE)	LIST PRICE EA.
650WS	Wire shelf for BAR650	5.50 (1.23)	\$ 66.00
730WS	Wire shelf for BAR730	5.1 (1.49)	46.00
730SR	7 Bottle Speed Rail	5.25 (1.33)	105.00
BAR54SR	5 Bottle Speed Rail	5.50 (1.33)	72.00
730BIBR	Bag in Box Racks (2)	—	330.00
650BIBR	Bag in Box Rack (1)	—	165.00

Case Pack: 1

LARGE CAMBARS® – Complete Systems BAR730

Post-mix System for 5-gallon, Bag-in-box Syrup

Holds up to 6 syrup boxes and 1 CO₂ tank

Standard Decor

Dimensions: L 72¾" x W 26" x H 48"

CODE	BAR730PM	BAR730PMT*	BAR730PMT20*
VOLTS	110	110	220
WATER TANK	NO	YES	YES
UNIT WEIGHT	324 lbs.	344 lbs.	344 lbs.
CASE LBS. (CUBE)	360 (58.75)	380 (58.75)	380 (58.75)
LIST PRICE	\$ 13,555.00	\$ 14,850.00	\$ 14,960.00

Designer Decor

Dimensions: L 77¾" x W 28½" x H 47½"

CODE	BAR730DSPM	BAR730DSPMT*	BAR730DSPMT2*
VOLTS	110	110	220
WATER TANK	NO	YES	YES
UNIT WEIGHT	362 lbs.	382 lbs.	382 lbs.
CASE LBS. (CUBE)	398 (67.02)	418 (67.02)	418 (67.02)
LIST PRICE	\$ 15,345.00	\$ 17,325.00	\$ 17,435.00

BAR730PM and BAR730DSPM

Includes the standard equipment from the Basic System plus

- Post-mix soda gun with 8 buttons
- Carbonator
- 2 stainless steel syrup box racks
- 6 bag-in-box pumps
- CO₂ regulator gauge & tubing, hose & lines
- Line for city water hook-up

BAR730PMT, BAR730DSPMT, BAR730PMT2 & BAR730DSPMT2

Includes all the above plus 1, 17-gallon (64,3 L) water tank and 1 water pump. Line for city water hook-up not included.



Vinyl cover included with all CamBars. Cover not NSF listed.



BAR730DX



BAR730DSPMT (with water tank)

Pre-mix System for 5-gallon (18,9 L) Soda Canisters

Holds up to 7 canisters and 1 CO₂ tank

	Standard Decor	Designer Decor
CODE	BAR730DX	BAR730DSDX
DIMENSION	L 72¾" x W 26" x H 48"	L 77¾" x W 28½" x H 47½"
WATER TANK	NO	YES
UNIT WEIGHT	264 lbs.	274 lbs.
CASE LBS. (CUBE)	356 (63.56)	338 (67.02)
LIST PRICE	\$ 8,910.00	\$ 12,045.00

BAR730DX and BAR730DSDX

Includes

- Pre-mix soda gun with 6 buttons
- Sealed-in cold plate w/8 circuits
- CO₂ chain
- 7-bottle speed rail
- 80-pound (36,3 kg.) capacity ice sink
- Ice sink cover
- Waste-water bin
- 2 retainer straps
- 4, 6" (15,2 cm) swivel casters, 2 with brake
- Vinyl cover



BAR730DX

LARGE CAMBARS® – Economy and Basic Systems BAR730

ECONOMY SYSTEM BAR730

For Bottle, Can or Mixer Service

	Standard Decor	Designer Decor
CODE	BAR730	BAR730DS
DIMENSION	L 72¾" x W 26" x H 48"	L 77¾" x W 28½" x H 47½"
UNIT WEIGHT	205 lbs.	232 lbs.
CASE LBS. (CUBE)	229 (58.75)	295 (67.02)
LIST PRICE	\$ 5,240.00	\$ 7,180.00

Includes

- 7-bottle speed rail
- 80-pound (36,3 kg.) capacity ice sink
- Ice sink cover
- Waste-water bin
- 2 retainer straps
- 4, 6" (15,2 cm.) swivel casters, 2 with brake
- Vinyl cover



BAR730DS
(shown with four optional wire racks)

BASIC SYSTEM BAR730

Partially Equipped for Soda Service

Requires customer installation of pre-mix or post-mix soda gun system

	Standard Decor	Designer Decor
CODE	BAR730CP	BAR730DSCP
DIMENSION	L 72¾" x W 26" x H 48"	L 77¾" x W 28½" x H 47½"
UNIT WEIGHT	254 lbs.	292 lbs.
CASE LBS. (CUBE)	290 (58.75)	409 (68.46)
LIST PRICE	\$ 7,645.00	\$ 10,945.00

Includes

- Sealed-in cold plate w/8 circuits
- CO₂ chain
- 7-bottle speed rail
- 80-pound (36,3 kg.) capacity ice sink
- Ice sink cover
- Waste-water bin
- 2 retainer straps
- 4, 6" (15,2 cm.) swivel casters, 2 with brake
- Vinyl cover



BAR730DSCP shown with four optional wire racks.

MID-SIZE CAMBAR® – Complete Systems BAR650

Post-mix System for 5-gallon (18,9 L)

Bag-in-box Syrup

Holds up to 3 syrup boxes and 1 CO₂ tank

Standard Decor

Dimensions: L 67½" x W 28½" x H 47½"

CODE	BAR650PM	BAR650PMT	BAR650PMT220
VOLTS	110	110	220
WATER TANK	NO	YES	YES
UNIT WEIGHT	335 lbs.	355 lbs.	355 lbs.
CASE LBS. (CUBE)	360 (59.09)	380 (59.09)	360 (59.09)
LIST PRICE	\$ 12,635.00	\$ 13,880.00	\$ 14,300.00

Designer Decor

Dimensions: L 67½" x W 28½" x H 47½"

CODE	BAR650DSPM	BAR650DSPMT*	BAR650DSPMT2*
VOLTS	110	110	220
WATER TANK	NO	YES	YES
UNIT WEIGHT	342 lbs.	362 lbs.	362 lbs.
CASE LBS. (CUBE)	367 (59.09)	387 (59.09)	450.50 (59.56)
LIST PRICE	\$ 13,970.00	\$ 15,785.00	\$ 15,895.00

BAR650PM and BAR650DSPM

Includes the standard equipment from Basic System plus

- Post-mix soda gun with 5 buttons
- Carbonator
- Stainless steel syrup box rack
- 3 bag-in-box pumps
- CO₂ regulator gauge & tubing, hose & lines
- Line for city water hook-up

BAR650PMT, BAR650DSPMT, BAR650PMT2 & BAR650DSPMT2

Includes all the above plus 1, 17-gallon (64,3 L) water tank and 1 water pump. Line for city water hook-up not included.



BAR650DSPMT
(with water tank)

Pre-mix System for 5-gallon (18,9 L) Soda Canisters

Holds up to 5 canisters and 1 CO₂ tank

	Standard Decor	Designer Decor
CODE	BAR650DX	BAR650DSDX
DIMENSION	L 67½" x W 28½" x H 47½"	L 67½" x W 28½" x H 47½"
UNIT WEIGHT	285 lbs.	292 lbs.
CASE LBS. (CUBE)	340.2 (52.91)	317 (59.09)
LIST PRICE	\$ 8,370.00	\$ 10,175.00

BAR650DX and BAR650DSDX

Includes

- Pre-mix soda gun with 5 buttons
- Sealed-in cold plate w/8 circuits
- CO₂ chain
- 7-bottle speed rail
- 80-pound (36,3 kg.) capacity ice sink
- Ice sink cover
- Waste-water bin
- Retainer strap
- 4, 6" (15,2 cm.) swivel casters, 2 with brake
- Vinyl cover



BAR650DSDX

MID SIZE AND SMALL CAMBARS® – Economy and Basic Systems

ECONOMY SYSTEM BAR650 – MID-SIZE MODEL

For Bottle, Can or Mixer Service

	Standard Decor	Designer Decor
CODE	BAR650	BAR650DS
DIMENSION	L 67½" x W 28½" x H 47½"	L 67½" x W 28½" x H 47½"
UNIT WEIGHT	185 lbs.	192 lbs.
CASE LBS. (CUBE)	210 (59.09)	217 (59.09)
LIST PRICE	\$ 4,480.00	\$ 6,155.00

Includes

- 7-bottle speed rail
- 80-pound (36,3 kg.) capacity ice sink
- Ice sink cover
- Waste-water bin
- Retainer strap
- 4, 6" (15,2 cm.) swivel casters, 2 with brake
- Vinyl cover



BAR650DS
(shown with two optional wire racks)

BASIC SYSTEM BAR650 – MID-SIZE MODEL

Partially Equipped for Soda Service

Requires customer installation of pre-mix or post-mix soda gun system

	Standard Decor	Designer Decor
CODE	BAR650CP	BAR650DSCP
DIMENSION	L 67½" x W 28½" x H 47½"	L 67½" x W 28½" x H 47½"
UNIT WEIGHT	264 lbs.	271 lbs.
CASE LBS. (CUBE)	317.8 (52.91)	307 (59.09)
LIST PRICE	\$ 6,750.00	\$ 8,800.00

Includes

- Sealed-in cold plate with 8 circuits
- CO₂ chain
- 7-bottle speed rail
- 80-pound (36,3 kg.) capacity ice sink
- Ice sink cover
- Waste-water bin
- Retainer strap
- 4, 6" (15,2 cm.) swivel casters, 2 with brake
- Vinyl cover



BAR650DSCP
(shown with two optional wire racks)

ECONOMY SYSTEM BAR540 – SMALL MODEL

For Bottle, Can, or Mixer Service

Dimensions: L 54" x W 25½" x H 46½"

	Standard Decor	Designer Decor
CODE	BAR540	BAR540DS
UNIT WEIGHT	115 lbs.	120 lbs.
CASE LBS. (CUBE)	140 (39.57)	145 (39.57)
LIST PRICE	\$ 2,250.00	\$ 2,900.00

Includes

- 5-bottle speed rail
- 80-pound (36,3 kg.) capacity ice sink
- 4, 5" (12,7 cm) swivel casters, 2 with brake
- Vinyl cover



BAR540DS

SLIDINGLID™ ICE CADDIES

- Polyethylene body and thick foam insulation hold ice for days.
- Rugged, all-weather exterior will not crack, dent, bubble, chip, rust or break.
- Unique sliding lid slides back and under during use, reducing risk of cross-contamination.
- Recessed well and drain shelf keep ice out of water, extending holding times.
- Recessed, molded-in handles ease lifting and maneuvering.
- No assembly required.



ICS125L
(Short)



ICS175T
(Tall)



ICS175LB
(Short) Shown with Rear Easy Wheels.



ICS175TB
(Tall) Shown with Rear Easy Wheels.



ICS200TB
(Tall) Shown with Rear Wide Easy Wheels.



ICS100L4S
(Short)

ICS100L
(Short)



These units feature a slant top sliding lid, hold up to 100 lbs. of ice and fit under prep/catering tables, counters or the CamKiosk Bridge.



Colors: Black (110), Slate Blue (401), Dark Brown (131), Coffee Beige (157), Gray (180), Granite Gray (191), Granite Green (192).

Personalization available. Special quote only. Contact customer service.

SlidingLid Ice Caddies ICS125L and ICS125LB are covered by US Patent D 468,071 S.



Caster Descriptions

Refers to caster type in chart.
All casters are 5".

A: 2 fixed, 2 swivel, 1 with brake

A1: 2 swivel, 2 locking

B: 4 swivel, 1 with brake

C: 2 swivel, 1 with brake,
2, 8" Easy Wheels

D: 2 swivel, 1 with brake,
2, 10" Easy Wheels

E: 2 swivel, 1 with brake,
2, 10" Wide Easy Wheels



CODE	HOLDING CAPACITY LBS.	EXTERIOR DIMENSIONS W x D x H	CASTER TYPE	CASE LBS. (CUBE)	LIST PRICE EA.
Short					
ICS100L	100	22½" x 30¼" x 28¾"	A1	53 (11.54)	\$ 875.00
ICS100L4S	100	22½" x 30¼" x 28¾"	B	59 (11.88)	900.00
ICS125L	125	23" x 31½" x 29¼"	A	60.33 (13.33)	895.00
ICS125LB	125	23" x 31½" x 29¼"	C	71 (13.16)	965.00
ICS175L	175	24" x 37½" x 29¼"	A	78 (16.3)	1,070.00
ICS175LB	175	24" x 37½" x 29¼"	D	80 (16.3)	1,110.00
Tall					
ICS125T	125	23" x 31½" x 34½"	A	70.6 (15.46)	955.00
ICS175T	175	23" x 34" x 37½"	A	80.6 (18.06)	1,120.00
ICS175TB	175	23" x 34" x 37½"	D	83.67 (18.25)	1,195.00
ICS200TB	200	23" x 34" x 39½"	E	98 (19)	1,225.00

Case Pack: 1

InStock Colors: Black (110), Dark Brown (131).

INSULATED TRANSPORT

Camtainers® Beverage Servers

Camservers®

Handwash Accessories

Insulated Food Pan Carriers

Temperature Maintenance Tools

Insulated Front Loading
Camcarriers®

Ultra Pan Carriers®

Ultra Camcarts®

Combo Carts™

Camcarts®

Camtherm® Holding Cabinets

Beverage Service Carts

Meal Delivery Carts



CAMBRO
EQUIPMENT
DESIGNED FOR DURABILITY

Consultant Cut Sheets and
CAD drawings are available
on www.cambro.com





CAMSERVER® – Holds the heat for hours.

- A front-of-house beverage server for hot or cold beverages that does not require canned heating.
- Double-wall polyethylene shell with thick foam insulation retains temperatures for hours.
- Wide nylon latches are easy to open and close with one hand.
- A perfect height for filling large cups or coffee pots.
- Two double-sided, brass snap-on identifier plates included: *coffee/decaf* and *tea/hot water*.

Colors: Black (110), Dark Taupe (417), Granite Gray (191).

Camserver is covered by U.S. Patent D 363,634.



Convenient top-fill opening for fast replenishment without removing lid.



CSR5
Shown in Black

CSR3
Shown in Dark Taupe

Height is approximately 7" from counter to spigot.

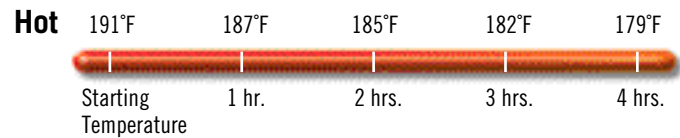

CODE	OVERALL DIMENSIONS H x W x D	CAPACITY	7 OZ. CUPS	CASE LBS. (CUBE)	LIST PRICE EA.
CSR3	23½" x 13¼" x 18¼"	3 gal.	54	18.35 (3.58)	\$ 435.00
CSR5	28" x 13¼" x 18¼"	5 gal.	91	21.79 (4.02)	450.00

Case Pack: 1

HANDWASH ACCESSORIES



Shown with 500LCD Camtainer®

- Set up a Handwashing Station quickly and easily on or off premise.
- Convenient and economical way to meet health department hand washing requirements.
- Attaches to 2½-gallon (9.5 L) or 5-gallon (19 L) Camtainers® or Ultra Camtainers®.
- Includes four *Handwash Only* labels and an Easy Serve Dispenser lever.

Handwash Accessory Stocking Colors: Dark Brown (131), Black (110).

Easy Serve Dispenser Color: Black (110).

Riser Colors: See optional accessories with Camtainers.

Pail with Bail Color: White (148).

Handwash Accessory is covered by the following U.S. Patents: D 506,634 S, D 506,899 S & D 548,980 S.



CODE	HWAPR	HWATD
DESCRIPTION	With Paper Towel Roll Holder	With Multi-Fold Paper Towel Dispenser
FITS	250LCD, 500LCD, UC250, UC500	250LCD, 500LCD, UC250, UC500
CASE LBS. (CUBE)	9.75 (2.06)	10.3 (2.03)
LIST PRICE EACH	\$ 240.00	\$ 315.00

Optional Accessories

CODE	DESCRIPTION	CASE LBS. (CUBE)	LIST PRICE EA.
R500LCD	Riser	2.6 (0.49)	\$ 85.00
PWB22	Pail with Bail	14 (3.2)	23.30
LCDES	Easy Serve Dispenser	0.25 (0.01)	17.05

R500LCD, PWB22, LCDES are NSF listed.

INSULATED BEVERAGE SERVERS

- Use to hold, transport and serve hot or cold beverages.
- One piece, seamless double-wall polyethylene with thick foam insulation.
- Sturdy latches secure lids tightly and will never rust.
- Drip-proof recessed spigot for easy self-serve access.
- Stack units on riser to fill large cups or coffee pots.
- Sta-stack interlocking ensures stable stacking during transport and storage.

UC250 and UC500 covered by U.S. Patent D 403,917. UC1000 covered by U.S. Patent D 403,916.

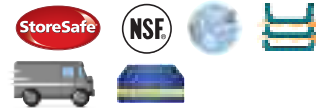

Vent Cap

Equalizes pressure. Makes opening the container much easier.

E-Z Grip Molded-in Handles

For comfortable, safe transporting.



Recessed Faucet

Accommodates larger cups. Allows even dispensing and eliminates drips. Two positions: one for continuous pouring and one for individual dispensing.



Molded-in Metal Backing Plates

Prevents latches from breaking away from the container.



Ultra Camtainers®

Feature wide nylon latches which are easy to open and close with one hand.



Camtainers®

Feature sturdy plastic latches that secure lids tightly and will never rust.



Stack beverage servers during storage and transporting to save space.

Stacking options:

- 100LCD with 100LCD
- All 250, 350 and 500 units
- UC1000 and 1000LCD

Hot

250LCD	188°F	184°F	179°F	174°F	170°F
--------	-------	-------	-------	-------	-------

UC250	190°F	186°F	183°F	179°F	176°F
-------	-------	-------	-------	-------	-------



Starting Temperature	1 hr.	2 hrs.	3 hrs.	4 hrs.
----------------------	-------	--------	--------	--------

Cold

250LCD	33.5°F	35°F	36°F	38°F	39°F
--------	--------	------	------	------	------

UC250	33°F	33.5°F	34°F	35°F	36°F
-------	------	--------	------	------	------



Starting Temperature	1 hr.	2 hrs.	3 hrs.	4 hrs.
----------------------	-------	--------	--------	--------

ULTRA CAMTAINERS®

Choose from three sizes for beverage service. A contemporary line, featuring two wide nylon latches per unit that are easy to open and close.



CODE	UC250	UC500	UC1000
CAPACITY	2¼ gal.	5¼ gal.	10½ gal.
7 OZ. CUPS	50	96	192
EXTERIOR DIM. D x W x H	16¾" x 11¾" x 19¾"	16¾" x 11¾" x 26½"	20½" x 16¼" x 25¾"
FITS CAMDOLLY®	CD100, CD100H, CD100HB	CD100, CD100H, CD100HB	CD300, CD300H, CD300HB
CASE LBS. (CUBE)	15.10 (2.41)	18.86 (3.22)	29.19 (5.24)
LIST PRICE EACH	\$ 245.00	\$ 280.00	\$ 380.00

Case Pack: 1 Colors: Navy Blue (186), Slate Blue (401), Coffee Beige (157), Dark Brown (131), Brick Red (402), Green (519), Black (110), Granite Gray (191), Granite Green (192), Granite Sand (194). InStock Colors: Dark Brown (131), Black (110), Granite Gray (191). Venting plug is covered by US Patent D 553,717 S.

CAMTAINERS®

The standard for many caterers. Four sturdy plastic latches on each unit open and close easily and will never rust.



CODE	100LCD	250LCD	500LCD	1000LCD	350LCD (SOUP)
CAPACITY	1½ gal.	2½ gal.	4¾ gal.	11¼ gal.	3¾ gal.
7 OZ. CUPS	27	45	86	214	61
SPIGOT	YES	YES	YES	YES	—
EXTERIOR DIM. D x W x H	11½" x 10¾" x 17¼"	16½" x 9" x 18¾"	16½" x 9" x 24¼"	20¾" x 16¼" x 24¾"	16½" x 9" x 18¾"
FITS CAMDOLLY®	—	CD100, CD100H, CD100HB	CD100, CD100H, CD100HB	CD300, CD300H, CD300HB	CD100, CD100H, CD100HB
CASE LBS. (CUBE)	9.50 (1.24)	12.75 (1.73)	15.50 (2.26)	12.6 (5.27)	13.4 (1.65)
LIST PRICE EACH	\$ 200.00	\$ 215.00	\$ 245.00	\$ 375.00	\$ 210.00

Case Pack: 1 Colors: Navy Blue (186), Slate Blue (401), Coffee Beige (157), Dark Brown (131), Brick Red (402), Green (519), Black (110), Hot Red (158). InStock Colors: Dark Brown (131), Black (110). Venting plug is covered by US Patent D 553,717 S.

OPTIONAL ACCESSORIES



CODE	R500LCD	R1000LCD	LCDCH	LCDCH10	LCDES
DESCRIPTION	Riser	Riser	Condiment Holder	Condiment Holder	Easy Serve Dispenser
EXTERIOR DIM. D x W x H	16¼" x 9¾" x 4¾"	19½" x 15¾" x 4½"	16½" x 8¾" x 5"	20" x 16" x 4¾"	—
FITS	250LCD, 500LCD, UC250, UC500	1000LCD, UC1000	250LCD, 500LCD, UC250, UC500	1000LCD, UC1000	LCD Spigots, UC Spigots
CASE LBS. (CUBE)	2.6 (0.49)	5.45 (0.93)	2.55 (0.5)	5.75 (1.07)	0.25(0.01)
LIST PRICE EACH	\$ 85.00	\$ 95.00	\$ 80.00	\$ 120.00	\$ 17.05

Case Pack: 1 Colors: Navy Blue (186), Slate Blue (401), Coffee Beige (157), Dark Brown (131), Brick Red (402), Green (519), Black (110), Hot Red (158), Granite Gray (191), Granite Green (192), Granite Sand (194). Easy Serve Dispenser Color: Black (110).

INSULATED FOOD PAN CARRIERS

- Top-loading food pan carriers hold, transport and serve a single full-size pan of hot or cold food.
- Sturdy and durable, seamless polyethylene or polypropylene with thick foam insulation.
- Molded-in handles on all four sides for easy carrying and handling.
- 100 Series interstacks within the series and 240MPC stacks only with 240MPCs.
- Use with divider bars to hold multiple fractional pans.
- Pans are easy to remove using finger notches.
- Carriers interlock and stack for transporting and storing.

UPCS Colors: Dark Brown (131), Speckled Gray (480), Slate Blue (401), Coffee Beige (157), Black (110).

MPC and MPCHL Colors: Navy Blue (186), Slate Blue (401), Coffee Beige (157), Dark Brown (131), Brick Red (402), Green (519), Black (110), Hot Red (158).

UPC Colors: Slate Blue (401), Coffee Beige (157), Dark Brown (131), Brick Red (402), Black (110), Granite Gray (191), Granite Green (192), Granite Sand (194).

Camdolly® Colors: Coffee Beige (157), Dark Brown (131), Black (110), Slate Blue (401), Gray (180).

Divider Bar Colors: White (148), Clear (135).

See Food Pan Section and Camdolly® Section for pricing and ordering information.

Note: Place food pans on rails. Pans should not be placed on the floor of a Camcart or Camcarrier® cavity.

Note: If using metal food pans, cool to 250°F before placing into carriers.



UPCS160

CD160

Hot

UPC160	189°F	185°F	181°F	178°F	175°F
UPCS160	189°F	185°F	181°F	178°F	175°F
Starting Temperature	1 hr.	2 hrs.	3 hrs.	4 hrs.	

Cold

UPC160	33°F	34°F	35°F	35.5°F	36.5°F
UPCS160	33°F	34°F	35°F	35.5°F	36.5°F
Starting Temperature	1 hr.	2 hrs.	3 hrs.	4 hrs.	



UPC140

UPC100

No divider bars available for UPC100.

UPC160

Shown with dividers and fractional sized food pans.

CAMCARRIERS®

One-piece, seamless polyethylene construction, airtight removable gasket and sturdy plastic latches.



CODE	125MPC	240MPC
COMPARTMENT CAPACITY	1 full size 2½" deep pan	1 half size 2½" deep pan or 1 half size 4" deep pan
EXTERIOR DIM. W x D x H	24½" x 16¼" x 6"	16½" x 13¾" x 7½"
FITS CAMDOLLY®	CD160	—
CASE LBS. (CUBE)	16 (1.53)	8.7 (1.2)
LIST PRICE EACH	\$ 275.00	\$ 255.00

Case Pack: 1

S-SERIES

Durable polypropylene construction, built in seal and wide, nylon latches. Contemporary appearance and superior holding performance at an economical price.



CODE	UPCS140	UPCS160	UPCS180	UPCSS160*
COMPARTMENT CAPACITY	1 full size 4" deep pan	1 full size 6" deep pan	1 full size 8" deep pan	1 full size 6" deep pan
EXTERIOR DIM. W x D x H	25 $\frac{1}{8}$ " x 17 $\frac{3}{8}$ " x 8 $\frac{1}{2}$ "	25 $\frac{1}{8}$ " x 17 $\frac{3}{8}$ " x 10 $\frac{1}{4}$ "	25 $\frac{1}{8}$ " x 17 $\frac{3}{8}$ " x 12"	24 $\frac{1}{2}$ " x 16 $\frac{1}{2}$ " x 9 $\frac{1}{4}$ "
FITS CAMDOLLY®	CD160	CD160	CD160	CD160
CASE LBS. (CUBE)	17.5 (2.37)	19 (2.58)	20 (3.33)	17 (2.47)
LIST PRICE EACH	\$ 230.00	\$ 240.00	\$ 260.00	\$ 240.00

Case Pack: 1

* UPCSS160 available in Dark Brown (131), Speckled Gray (480) and Coffee Beige (157) only.

ULTRA PAN

One-piece, seamless polyethylene construction, airtight removable gasket and wide, nylon latches.



CODE	UPC140	UPC160	UPC180
COMPARTMENT CAPACITY	1 full size 4" deep pan	1 full size 6" deep pan	1 full size 8" deep pan
EXTERIOR DIM. W x D x H	24 $\frac{3}{4}$ " x 17 $\frac{3}{8}$ " x 8 $\frac{1}{8}$ "	24 $\frac{3}{4}$ " x 17 $\frac{3}{8}$ " x 10 $\frac{1}{8}$ "	24 $\frac{3}{4}$ " x 17 $\frac{3}{8}$ " x 12"
FITS CAMDOLLY®	CD160	CD160	CD160
CASE LBS. (CUBE)	16.6 (2.15)	20 $\frac{1}{4}$ (2.72)	21 $\frac{1}{2}$ (3.18)
LIST PRICE EACH	\$ 345.00	\$ 350.00	\$ 360.00

Case Pack: 1

100 SERIES

Store and stack food pans or place packaged food directly in compartment. The 100MPCHL model has a hinged serving lid.



CODE	100MPC	100MPCHL	UPC100	UPC101
COMPARTMENT CAPACITY	3 full size 2 $\frac{1}{2}$ " deep pan or 2 full size 4" deep pans or 1 full size 6" or 8" deep pan	1 full size 8" deep pan	3 full size 2 $\frac{1}{2}$ " deep pans or 2 full size 4" deep pans or 1 full size 6" or 8" deep pan	3 full size 2 $\frac{1}{2}$ " deep pan or 2 full size 4" deep pans or 1 full size 6" or 8" deep pan
EXTERIOR DIM. W x D x H	26 $\frac{3}{4}$ " x 18" x 15"	26 $\frac{3}{4}$ " x 18" x 15 $\frac{1}{2}$ "	26 $\frac{3}{4}$ " x 18" x 15 $\frac{1}{4}$ "	26 $\frac{3}{4}$ " x 18" x 12 $\frac{1}{2}$ "
INTERIOR DIM. W x D x H	21 $\frac{3}{4}$ " x 13 $\frac{3}{4}$ " x 8"	21 $\frac{3}{4}$ " x 13 $\frac{3}{4}$ " x 8"	22 $\frac{1}{4}$ " x 13" x 8"	21 $\frac{1}{8}$ " x 13 $\frac{3}{8}$ " x 8 $\frac{1}{4}$ "
BULK CAPACITY*	40 qts.	40 qts.	40 qts.	40 qts.
FITS CAMDOLLY®	CD100, CD100H, CD100HB	CD100, CD100H, CD100HB	CD100, CD100HB	CD100, CD100HB
CASE LBS. (CUBE)	27 (4.51)	30 (4.51)	25 $\frac{1}{4}$ (4.63)	24 $\frac{1}{2}$ (3.75)
LIST PRICE EACH	\$ 365.00	\$ 460.00	\$ 395.00	\$ 395.00

Case Pack: 1

* Without using food pans.

Accessories

DESCRIPTION	CODE	OVERALL EXTERIOR DIMENSIONS	CASE PACK	CASE LBS. (CUBE)	LIST PRICE EA.
Divider Bars		Length			
	DIV12	12 $\frac{3}{4}$ "	3	1 (0.02)	\$ 3.55
	DIV20	20 $\frac{3}{4}$ "	3	2 (0.10)	\$ 8.85

CAMCHILLER®, THERMOBARRIER® & CAMWARMER®

Camchiller

- An easy-to-use, cold food holding temperature tool.
- Extend cold holding time or enhance safe holding below 41°F (5°C) when frequent access is required.
- Freeze first then use to pre-chill cabinet before loading.

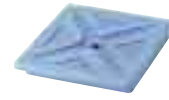
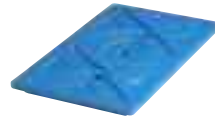

CODE	CP1220 (GN FULL SIZE)	CP1210 (GN HALF SIZE)
FITS INTO	300MPC, UPC400, UPCS400, UPC600, UPC800, UPC1200*, UPC1600*, 1318MTC, CVC72*, CVC724*, CMB1826, CMB1826L, UPCSS160 and CamKiosk®*	125MPC, 140MPC, 150MPC, 160MPC, 180MPC, 300MPC, UPC140, UPC160, UPC180, UPC400, UPCS400, UPC600, UPC800, UPCS140, UPCS160, UPCS180, 1318MTC, CVC724*, CVC72* and CamKiosk®*
QUANTITY PER CAVITY	1 (2 per cabinet recommended*)	1 or 2
DIMENSIONS L x W x H	20 ¹³ / ₁₆ " x 12 ⁷ / ₈ " x 1 ¹ / ₂ "	10 ³ / ₈ " x 12 ³ / ₄ " x 1 ¹ / ₂ "
CASE LBS. (CUBE)	8.15 (0.32)	3.8 (0.18)
LIST PRICE EACH	\$ 125.00	\$ 64.00

Case Pack: 1

InStock Color: Cold Blue (159).

*Top wells only



1/2 size only.

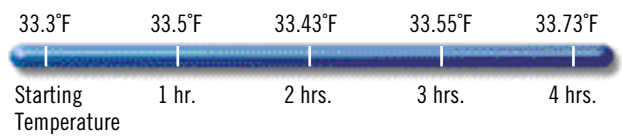

ThermoBarrier

- A highly valuable yet economical temperature maintenance tool for caterers.
- Use to minimize empty space and food temperature loss within a partially loaded compartment.

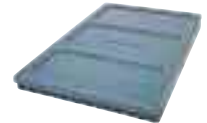
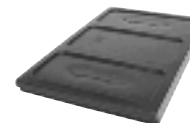
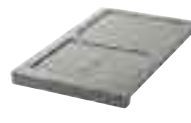

CODE	300DIV	400DIV	1200DIV	1600DIV
FITS INTO	300MPC, UPC600, 1318MTC	UPC400, UPCS400, UPC800	UPC1200, CVC72, CVC724	UPC1600, CamKiosk
QUANTITY PER COMPARTMENT	1	1	2	2
DIM. L x W x H	20 ¹³ / ₁₆ " x 12 ¹⁵ / ₁₆ " x 1"	21 ¹ / ₄ " x 13" x 1 ¹ / ₂ "	20 ⁷ / ₈ " x 12 ⁷ / ₈ " x 1 ³ / ₈ "	20 ⁷ / ₈ " x 13 ³ / ₈ " x 1 ¹ / ₂ "
COLOR	Coffee Beige (157)	Gray (180)	Dark Brown (131)	Slate Blue (401)
CASE PACK	1	1	2	2
CASE LBS (CUBE)	3.33 (0.31)	3.60 (0.35)	7.75 (0.67)	6.17 (0.55)
LIST PRICE EACH	\$ 70.00	\$ 70.00	\$ 70.00	\$ 70.00

InStock Colors: Coffee Beige (157), Gray (180).



Camwarmer

- Use for added insurance to keep hot foods hot during holding and transporting.
- Keep in cabinet with hot foods to extend holding time or enhance safe holding above 140°F (65°C) when frequent access is required.



CODE	1210PW
FITS INTO	UPC400, UPC400W, UPCS400, UPC600, UPC800, 300MPC, 1318MTC, 150MPC
DIMENSIONS L x W x H	13 ³ / ₄ " x 10 ⁷ / ₈ " x 1 ¹ / ₈ "
CASE LBS. (CUBE)	3.80 (0.17)
LIST PRICE EACH	\$ 173.25

Case Pack: 1

InStock Color: Granite Gray (191).



UPC400 with Camwarmer.

Two Camwarmers recommended per cavity. Place on bottom rail and store hot food above.

TEMPERATURE MAINTENANCE – Optimize Food Holding Performance.

Camchiller – GN Full Size and Half Size

- Use to:
 - Pre-chill cabinet cavity.
 - Hold packaged food in food pan wells. (Half Size Only)
 - Maximize cold food holding.
 - Minimize open cavity space.
- Easy to use:
 1. Freeze flat for 8 hours.
 2. Slide one or two on top rails and pre-chill cavity 15-20 minutes.
 3. Load in pans of pre-chilled food below Camchiller. (A)
 4. Move pans and Camchiller down as food is removed. (B)

COLD HOLDING

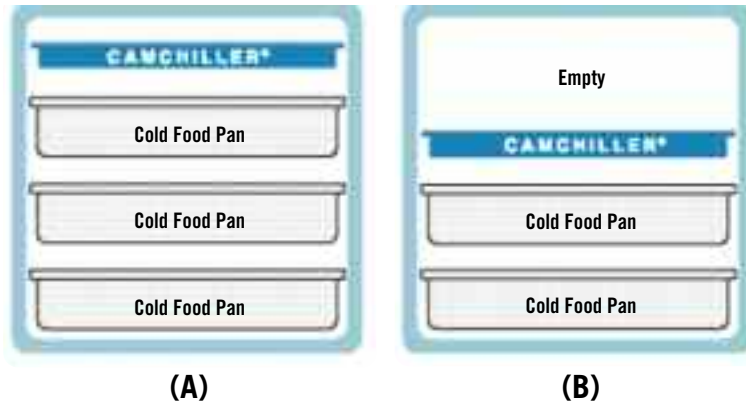

ThermoBarrier – Full Size

- Use to:
 - Hold hot and cold food in same cabinet cavity.
 - Minimize open cavity space.
- Easy to use:
 1. Slide between hot food on top and cold food on bottom. (A)
 2. Slide under hot food loaded in upper cavity space. (B)
 3. Slide above cold food loaded into lower cavity space. (C)

HOT AND COLD HOLDING



Camwarmer – Half Size

- Use to:
 - Pre-heat cabinet cavity.
 - Maximize hot food holding.
 - Minimize open cavity space.
- Easy to use:
 1. Heat in 350°F (180°C) oven for 45 minutes.
 2. Slide two Camwarmers on bottom rails and pre-heat cavity 15-20 minutes. (or place on high heat food pan lid or sheet pan)
 3. Load in pans of pre-heated food above Camwarmers. (A)
 4. Move pans and Camwarmers up as food is removed. (B)

HOT HOLDING

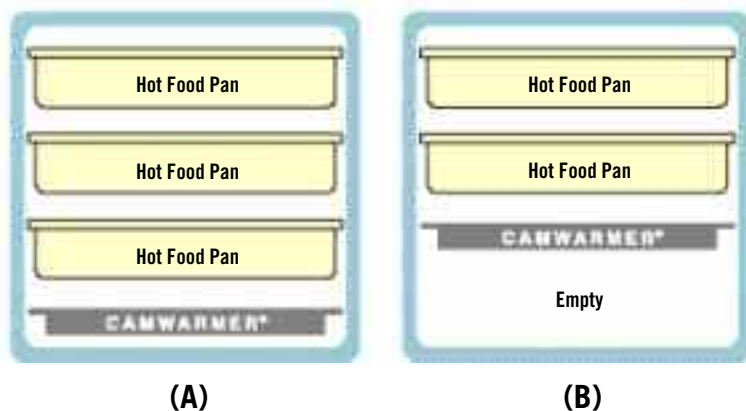

INSULATED FRONT LOADING CAMCARRIERS®

- Durable and dependable front-loading food pan carriers.
- Hold multiple pans of hot or cold food at safe temperatures for hours.
- Seamless polyethylene with thick foam insulation.
- Airtight removable gasket provides a secure seal.

300MPC Colors: Navy Blue (186), Slate Blue (401), Coffee Beige (157), Dark Brown (131), Brick Red (402), Green (519), Black (110), Hot Red (158).

See Camdolly®, Food Pan and Temperature Maintenance section for pricing, color and ordering information.

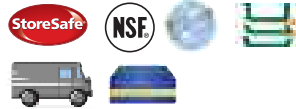

UPC400 Colors: Navy Blue (186), Slate Blue (401), Cold Blue (159), Coffee Beige (157), Dark Brown (131), Black (110), Granite Gray (191), Granite Green (192), Granite Sand (194).

UPC400 is covered by US Patent D 392,158. Venting plug is covered by US Patent D 553,717 S.

Note: Place food pans on rails. Pans should not be placed on the floor of a Camcarrier® cavity. Please use specified food pan sizes.

Note: If using metal food pans, cool to 250°F before placing onto rails.

Hot

UPC400	190°F	186°F	184°F	181°F	179°F
300MPC	187°F	181.5°F	177.5°F	174°F	170°F
Starting Temperature	1 hr.	2 hrs.	3 hrs.	4 hrs.	

Cold

UPC400	32.6°F	33.4°F	33.7°F	34.2°F	34.5°F
300MPC	33.6°F	34.4°F	35.4°F	36.2°F	37°F
Starting Temperature	1 hr.	2 hrs.	3 hrs.	4 hrs.	



UPC400 & CD400



300MPC



CODE	300MPC	UPC400 / UPC400TR**
EXTERIOR DIM. W x D x H	16½" x 24" x 23⅝"	18" x 25" x 24⅞"
INTERIOR DIM. W* x D x H	13¼" x 21" x 14"	13⅝" x 21" x 19⅞"
CASE LBS (CUBE)	30.17 (5.7)	33.23 (7.00)
LIST PRICE EACH	\$ 445.00	\$ 525.00 / \$ 550.00

Case Pack: 1 * Rail to Rail ** Tamper Resistant Model **300MPC InStock Colors:** Dark Brown (131), Black (110). **UPC400 InStock Colors:** Coffee Beige (157), Black (110).

HOLDING CAPACITY:

NUMBER OF GN ¼ PANS	PAN DEPTH	
	300MPC	UPC400
2½"	4	6
4"	3	4
6"	2	3
8"	1 + 1 each 2½"	2

Also holds GN ½ and ⅓ size pans.

OPTIONAL ACCESSORIES

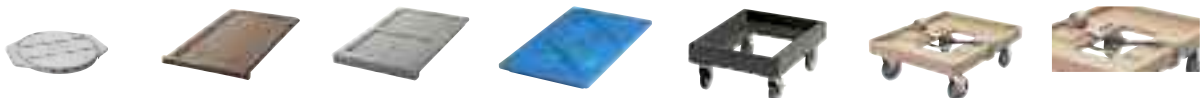

CODE	1210PW	300DIV	400DIV	CP1220	CD300*	CD400	400STP
DESCRIPTION	Camwarmer®	ThermoBarrier	ThermoBarrier	Camchiller	Camdolly®	Camdolly®	Strap
EXTERIOR DIM.	13¼" x 10⅞" x 1⅞"	20⅜" x 12⅝" x 1"	21¼" x 13" x 1½"	20⅜" x 12⅞" x 1½"	19⅜" x 25⅞" x 10⅞"	27⅞" x 20¼" x 9"	200" Long
INTERIOR DIM.	—	—	—	—	16⅜" x 23⅜"	25" x 18⅞"	—
COLOR	Granite Gray (191)	Coffee Beige (157)	Gray (180)	Cold Blue (159)	**	**	Beige (000)
CASE LBS. (CUBE)	3.80 (0.17)	3.33 (0.31)	3.60 (0.35)	8.15 (0.32)	17.5 (3.27)	19.60 (3.35)	1.22 (.11)
LIST PRICE EACH	\$ 173.25	\$ 70.00	\$ 70.00	\$ 125.00	\$ 280.00	\$ 310.00	\$ 15.00

Case Pack: 1 * Also available CD300H and CD300HB. See Camdolly section. **Camdolly Colors: Coffee Beige (157), Dark Brown (131), Black (110), Slate Blue (401), Gray (180).





ULTRA PAN CARRIER® S-SERIES

- Ultra dependable, ultra durable front-loading pan carrier.
- Holds multiple pans of hot or cold food for hours.
- Durable polyethylene shell and thick, polyurethane foam insulation.

UPCS400 Colors: Slate Blue (401), Speckled Gray (480), Dark Brown (131).

Casters: 5", 2 fixed, 2 swivel, 1 with brake.

Note: If using metal food pans, cool to 250°F before placing onto rails.

Full Size Food Pan Holding Capacity:

PAN DEPTH	NUMBER OF PANS
2½"	6
4"	4
6"	3
8"	2

Also holds ½ and ⅓ size pans.



Stacks with both UPCS400 and UPC400. Fits on CD400 Camdolly, or optional casters may be added for smooth ground transport.



CONVENIENT

Integrated pan-staging area eases service (not for use during transport).

ERGONOMIC DESIGN

Unbreakable, ergonomic, molded-in handles for comfortable two-person carrying.

EASY CONTENT AND ROUTING LABELING

Menu clip reduces need to open door.

EASY TO CLEAN

Door removes for easy cleaning.

PRESSURE CONTROL

Built-in vent.



TEMPERATURE RETENTION

Polyurethane insulation keeps hot food hot and cold food cold.



QUICK ACCESS

Single, 9" (23cm) nylon latch for quick and secure opening and closing.

BUILT-IN SEAL eliminates need for removable gasket.



Hot

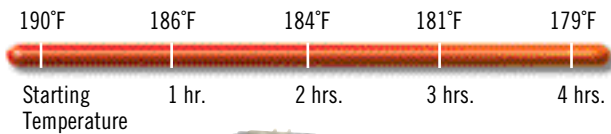

Cold

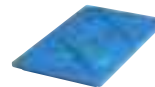
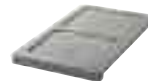
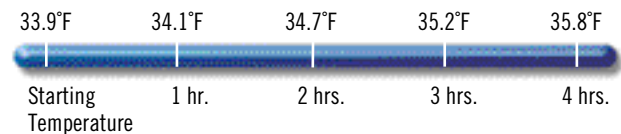

CODE	UPCS400	UPCS400CK	1210PW	400DIV	CP1220	CD400	400STP
DESCRIPTION	Insulated Carrier	Caster Kit	Camwarmer®	ThermoBarrier®	Camchiller®	Camdolly®	Strap
EXTERIOR DIM.	26¼" x 18" x 25"	—	13¼" x 10⅞" x 1⅞"	21¼" x 13" x 1"	20⅜" x 12⅞" x 1½"	27⅞" x 20¼" x 9"	200" Long
INTERIOR DIM.	21" x 13⅞" x 19⅞"	—	—	—	—	25" x 18⅞"	—
COLOR	*	—	Granite Gray (191)	Gray (180)	Cold Blue (159)	**	Beige (000)
CASE LBS. (CUBE)	47½ (7.38)	9% (0.21)	3.80 (0.17)	3.60 (0.35)	8.15 (0.32)	19.60 (3.35)	1.22 (.11)
LIST PRICE EACH	\$ 480.00	\$ 135.00	\$ 173.25	\$ 70.00	\$ 125.00	\$ 310.00	\$ 15.00

Case Pack: 1 *UPCS400 Instock Colors: Speckled Gray (480), Dark Brown (131).

**CD400 Colors: Coffee Beige (157), Dark Brown (131), Black (110), Slate Blue (401), Gray (180).

ULTRA CAMCARTS® FOR FOOD PANS

- Double-compartment, high-capacity carts hold and transport hot or cold food.
- Tough, polyethylene shell and thick foam insulation throughout cabinet and between compartments.
- Airtight removable gaskets maintain safe food temperatures for hours.
- Easy to maintain and won't dent, crack, rust, chip or break.
- Durable nylon door latches open easily and close securely.
- Full-swing doors open to the side of the cart for easy loading and unloading.
- Molded-in handles ensure easy maneuvering.
- Molded-in bumpers minimize damage to walls, furniture and other equipment.

Colors: Navy Blue (186), Slate Blue (401), Coffee Beige (157), Dark Brown (131), Brick Red (402), Green (519), Black (110), Hot Red (158), Granite Gray (191), Granite Green (192), Granite Sand (194).

Tamper-resistant models (for correctional industry) use hinge pins that cannot be removed.

Note: Place food pans on rails. Pans should not be placed on the floor of a Camcart cavity. Please use specified food pan sizes.

Note: If using metal food pans, cool to 250°F before placing onto rails.

Venting plug is covered by US Patent D 553,717 S.

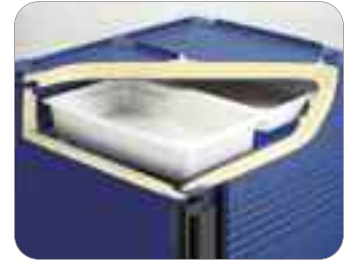

Polyurethane insulation keeps hot food hot and cold food cold.



Marine rail is designed for use during service, not transport.



TOTAL CART HOLDING CAPACITY	UPC600	UPC800	UPC1200	UPC1600
Full Size Food Pans				
2½" deep	8 pans	12 pans	16 pans	24 pans
4" deep	6 pans	8 pans	12 pans	16 pans
6" deep	4 pans	6 pans	8 pans	12 pans
8" deep	2 pans + 2 each 4" pans	4 pans	4 pans	8 pans
Camtray®*				
3253	12 trays	24 trays	24 trays	48 trays
2632	24 trays	48 trays	—	—
2025	—	—	12 trays	24 trays

See Food Pan and Camtray Section for pricing and ordering information.
*Based on 3" spacing between trays.

Hot

UPC600	187°F	181.5°F	177.5°F	174°F	170°F
UPC800	190°F	186°F	184°F	181°F	179°F
UPC1200	186°F	180°F	176°F	173°F	171°F
UPC1600	190°F	187°F	185°F	184°F	183°F

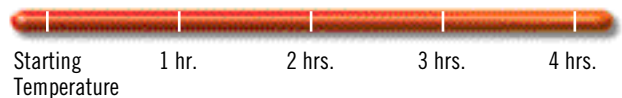

Cold

UPC600	33.6°F	34.4°F	35.4°F	36.2°F	37°F
UPC800	32.6°F	33.4°F	33.7°F	34.2°F	34.5°F
UPC1200	33°F	33.6°F	34°F	34.4°F	35°F
UPC1600	33°F	33.8°F	34.1°F	34.7°F	34.7°F

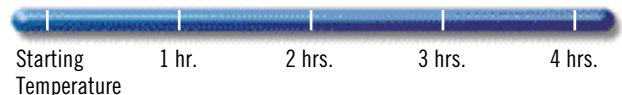



UPC600

CODE	UPC600
DESCRIPTION	Base Model
EXTERIOR DIM. W x D x H	20 ⁷ / ₈ " x 27 ¹ / ₈ " x 45"
COMPARTMENT DIMENSIONS	13 ⁵ / ₁₆ " x 21 ⁵ / ₁₆ " x 14"
CASE LBS. (CUBE)	71.6 (15.96)
LIST PRICE EACH	\$ 1,095.00
Case Pack: 1	Casters: 5", 2 fixed, 2 swivel, 1 with brake.



UPC800

CODE	UPC800	UPC800TR
DESCRIPTION	Base Model	Tamper Resistant
EXTERIOR DIM. W x D x H	20 ⁷ / ₈ " x 27 ¹ / ₈ " x 54"	20 ⁷ / ₈ " x 27 ¹ / ₈ " x 54"
COMPARTMENT DIMENSIONS	13" x 21 ¹ / ₂ " x 19 ¹ / ₈ "	13" x 21 ¹ / ₂ " x 19 ¹ / ₈ "
CASE LBS. (CUBE)	86 (19.28)	86 (19.28)
LIST PRICE EACH	\$ 1,290.00	\$ 1,300.00
Case Pack: 1	Casters: 6", 2 fixed, 2 swivel, 1 with brake.	



UPC1200

CODE	UPC1200
DESCRIPTION	Base Model
EXTERIOR DIM. W x D x H	28 ¹ / ₂ " x 32 ¹ / ₄ " x 45 ¹ / ₂ "
COMPARTMENT DIMENSIONS	21 ¹ / ₈ " x 26 ³ / ₈ " x 13 ¹ / ₂ "
CASE LBS. (CUBE)	108.67 (25.74)
LIST PRICE EACH	\$ 1,675.00
Case Pack: 1	Casters: 6", 2 fixed, 2 swivel, 1 with brake.



UPC1600



CODE	UPC1600	UPC1600TR
DESCRIPTION	Base Model	Tamper Resistant
EXTERIOR DIM. W x D x H	28 ³ / ₈ " x 32 ¹ / ₄ " x 53 ¹ / ₄ "	28 ³ / ₈ " x 32 ¹ / ₄ " x 53 ¹ / ₄ "
COMPARTMENT DIMENSIONS	21" x 26 ³ / ₈ " x 21"	21" x 26 ³ / ₈ " x 21"
CASE LBS. (CUBE)	111 (32.29)	122 (32.29)
LIST PRICE EACH	\$ 2,420.00	\$ 2,460.00
Case Pack: 1	Casters: 6", 2 fixed, 2 swivel, 1 with brake.	



CAMBRO
EQUIPMENT
DESIGNED FOR DURABILITY

Heavy-duty
6" x 2" hi-modulus
caster upgrade
available by
special order.

Optional Accessories

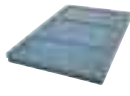
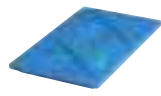
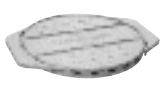
						
CODE	300DIV	400DIV	1200DIV	1600DIV	CP1220	1210PW
DESCRIPTION	ThermoBarrier	ThermoBarrier	ThermoBarrier	ThermoBarrier	Camchiller	Camwarmer
EXTERIOR DIMENSIONS	L x W x H 20 ¹⁵ / ₁₆ " x 12 ¹⁵ / ₁₆ " x 1"	L x W x H 21 ¹ / ₄ " x 13" x 1"	L x W x H 20 ³ / ₈ " x 13 ³ / ₈ " x 1 ³ / ₈ "	L x W x H 20 ⁷ / ₈ " x 13 ³ / ₈ " x 1 ³ / ₈ "	L x W x H 20 ¹⁵ / ₁₆ " x 12 ⁷ / ₈ " x 1 ¹ / ₂ "	L x W x H 13 ¹ / ₄ " x 10 ³ / ₈ " x 1 ¹ / ₁₆ "
FITS	UPC600	UPC800	UPC1200	UPC1600	UPC600, UPC800, UPC1200, UPC1600	UPC600, UPC800
COLOR	Coffee Beige (157)	Gray (180)	Dark Brown (131)	Slate Blue (401)	Cold Blue (159)	Granite Gray (191)
CASE LBS. (CUBE)	3.33 (0.31)	3.60 (0.35)	7.75 (0.67)	6.17 (0.55)	8.15 (0.32)	3.80 (0.17)
LIST PRICE EACH	\$ 70.00	\$ 70.00	\$ 70.00	\$ 70.00	\$ 125.00	\$ 173.25
Case Pack: 1	1200DIV & 1600DIV Case Pack: 2					



ULTRA PAN CARRIER® AND ULTRA CAMCART® H-SERIES

- Perfect for frequent opening and closing, extreme cold ambient temperatures and longer events.
- Extends hot food holding time and ensures food safety—an economical alternative to large warming cabinets.



Marine rail is designed for use during service, not transport.

Built-in thermometer easily removes for cleaning.

Non-corrosive heating unit maintains a safe temperature range of 150°-165°F (65,6°-73,9°C).

Molded-in handles won't break off.

Single 9" (23 cm) nylon latch provides quick and secure opening and closing.

Vent cap equalizes pressure and releases steam.

Tough, polyethylene exterior stays cool to the touch.



Removable cord stows securely for transport.



UPCH400



UPCH800



Thick foam insulation retains temperatures for hours, even when unplugged.

Both units are available in 110V and 220V models.

MODEL	UPCH400 / UPCH800 (110VAC MODELS)	UPCH400 / UPCH800 (220VAC MODELS)
Electrical Specifications		
Required Voltage	110 - 120 VAC	200 - 230 VAC
Maximum Amp.	2.0a	1.2a
Watts	230w	265w
Hertz	50/60	50/60
Plug Type	Nema 5-15P	Euro plug, CEE7
Cord Connector / Inlet	C15 / C16	C15 / C16
Power Cord Length	9 feet	2.7m

Capacity	UPCH400	UPCH800
2½" Deep Food Pan	6	12
4" Deep Food Pan	4	8
6" Deep Food Pan	3	6
8" Deep Food Pan	2	4

HOT HOLDING	150°-165°F (65°-74°C)
WARM UP TIME (from ambient to temperature)	45 minutes
RECOVERY TIME* (time to recover to temperature after door is held open for 30 seconds)	3 minutes
TRANSPORT TIME* (after reaching temperature, amount of time unit can be held passively/unplugged until contents reach 148°F (65°C).)	4 hours+

*Based on test with 4 full-sized, 4" (10 cm) deep H-Pans™ filled with 190°F (87,7°C) hot water.

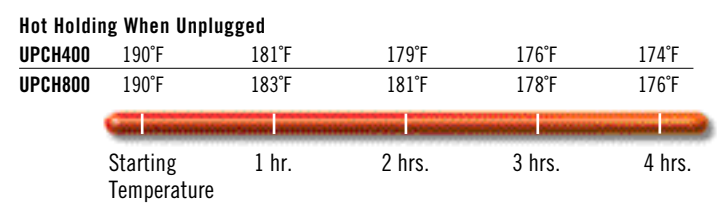

ULTRA PAN CARRIER® AND ULTRA CAMCART® H-SERIES

- Enables HACCP compliance by maintaining safe, hot food temperatures.
- Gentle, 150°-165°F (65,6°-73,9°C) heat will not cook food and maintains food moisture.
- Holds a wide variety of foods such as pasta, bone-in fried chicken, and double-crust pies.
- 45-minute preheat time from room temperature.
- Three minute recovery after the door is opened and closed.
- Uses less energy than three standard 100 watt light bulbs.
- UPCH400 models stack for storage or transporting on a Camdolly® with securing strap.
- Heated door kits also sold separately to retrofit UPC400 and UPC800.



144

CODE	DESCRIPTION	EXTERIOR DIMENSIONS W X D X H	COMPARTMENT DIMENSIONS W X D X H	CASE LB. (CUBE) CASE KG. (M³)	LIST PRICE EA.
1-Compartment Hot Holding Ultra Pan Carriers					
UPCH400	Heated Ultra Pan Carrier, 110V	18 3/8" x 26 3/8" x 24 7/8"	13 3/8" x 21" x 19 1/8"	45 (7.96)	\$ 1,095.00
UPCH4002	Heated Ultra Pan Carrier, 220V	46 x 67 x 63 cm	33,5 x 53,3 x 48,6 cm	20,45 (0,225)	1,095.00
UPCHW400	Heated Ultra Pan Carrier w/Casters, 110V	18 1/2" x 2 3/8" x 31 1/4"	13 3/8" x 21" x 19 1/8"	54 (9.98)	1,260.00
UPCHW4002	Heated Ultra Pan Carrier w/Casters, 220V	46 x 67 x 79,4 cm	33,5 x 53,3 x 48,6 cm	24,55 (0,283)	1,260.00
UPCHD400*	Heated UPCH400 Replacement/UPC400 Retrofit Door, 110V	18 3/8" x 3 1/2" x 21"	–	13 (0.93)	710.00
UPCHD4002*	Heated UPCH400 Replacement/UPC400Retrofit Door, 220V	46 x 9 x 53,3 cm	–	5,91 (0,026)	710.00
CD400	Camdolly®	20 3/4" x 27 3/8" x 9"	–	16 (3.21)	310.00
		53 x 70 x 23 cm	–	7,3 (0,09)	
400STP	Strap	200" long	–	1/2 (–)	15.00
		5 m long	–	0,5 (–)	
2-Compartment Hot Holding Ultra Camcarts					
UPCH800	Heated Ultra Camcart, 110V	20 1/2" x 27 1/8" x 54"	13" x 21 1/2" x 19 1/8"	102 (19.89)	\$ 2,475.00
UPCH8002	Heated Ultra Camcart, 220V	52 x 69 x 137,2 cm	33 x 54,5 x 48,5 cm	43,36 (0,563)	2,475.00
UPCHT800	Ultra Camcart with Heated Top Door Only, 110V	20 1/2" x 27 1/8" x 54"	13" x 21 1/2" x 19 1/8"	96 (19.89)	1,965.00
UPCHT8002	Ultra Camcart with Heated Top Door Only, 220V	52 x 69 x 137,2 cm	33 x 54,5 x 48,5 cm	43,64 (0,563)	1,965.00
UPCHTD800*	Heated UPCH800 Replacement/UPC800 Retrofit Top Door, 110V	18 3/8" x 3 1/2" x 21"	–	14.15 (0.93)	720.00
UPCHTD8002*	Heated UPCH800 Replacement/UPC800 Retrofit Top Door, 220V	46 x 9 x 53,3 cm	–	5,91 (0,026)	720.00
UPCHBD800*	Heated UPCH800 Replacement/UPC800 Retrofit Bottom Door, 110V	18 3/8" x 3 1/2" x 21"	–	13.9 (0.93)	720.00
UPCHBD8002*	Heated UPCH800 Replacement/UPC800 Retrofit Bottom Door, 220V	46 x 9 x 53,3 cm	–	5,91 (0,026)	720.00

UPCH Case Pack: 1. **CD400 Colors:** Coffee Beige (157), Dark Brown (131), Black (110), Slate Blue (401), Gray (180). **CD400 Case Pack:** 1 **InStock Colors:** Black (110), Dark Brown (131). **Casters:** 5" (12,7 cm) – 2 fixed, 2 swivel, 1 with brake. * NOTE: UPCH400, UPCH800 top and UPCH800 bottom replacement/retrofit doors are not interchangeable.

UPCH Colors



TRANSPORTER CAPACITY GUIDE

Loading Examples for Cambro® Insulated Transporters

TOP LOADERS

UPC140-UPC180
UPCS140-UPCS180
125MPC

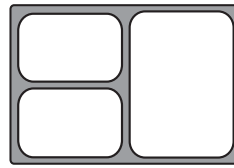
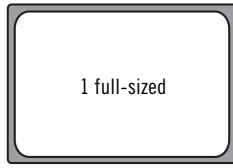

For a 3-course meal:
2 x GN ¼
1 x GN ½
1 DIV12 divider bar
(approx. 14 meals)

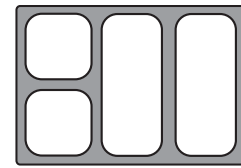

For a 4-course meal:
2 x GN ¼
2 x GN ½
2 DIV12 divider bars
(approx. 14 meals)

TOP LOADERS

100 series
100MPC
UPC100
UPC101

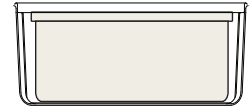
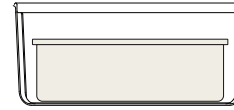
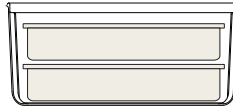
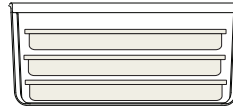

FRONT LOADERS

300MPC
UPC600 (x2)
UPC1200 (x4)

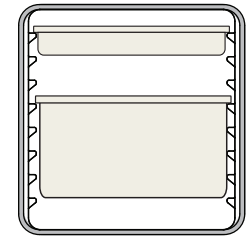
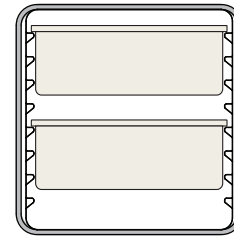
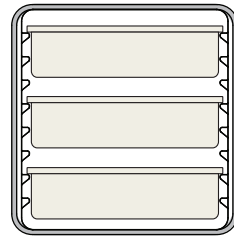
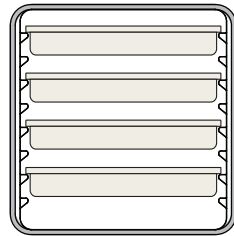
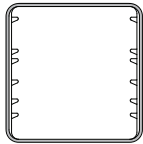

FRONT LOADERS

UPC400
UPCS400
UPCH400
UPC800 (x2)
UPCH800 (x2)
UPC1600 (x4)
CMB1826L (x2)
CMB1826 (x4)

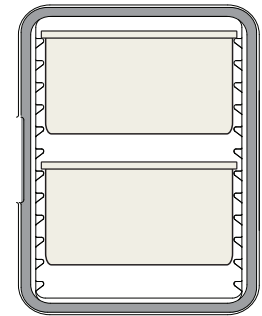
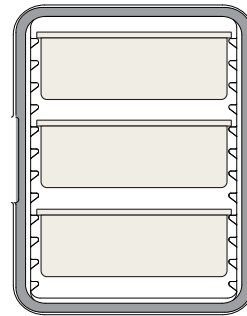
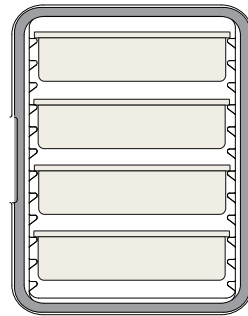
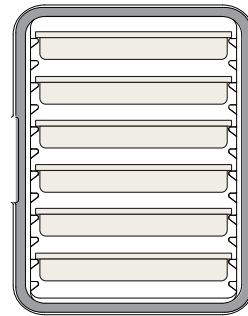

CAMCARRIERS® AND CAMCARTS® FOR SHEET PANS

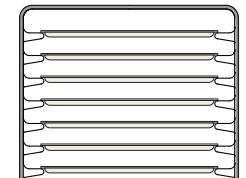
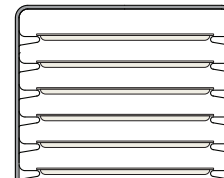
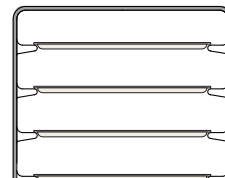
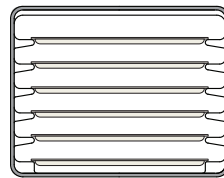
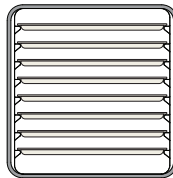

1826LTC
13 x full-size
sheet pans

SUMMARY OF GN CONTAINER SIZES

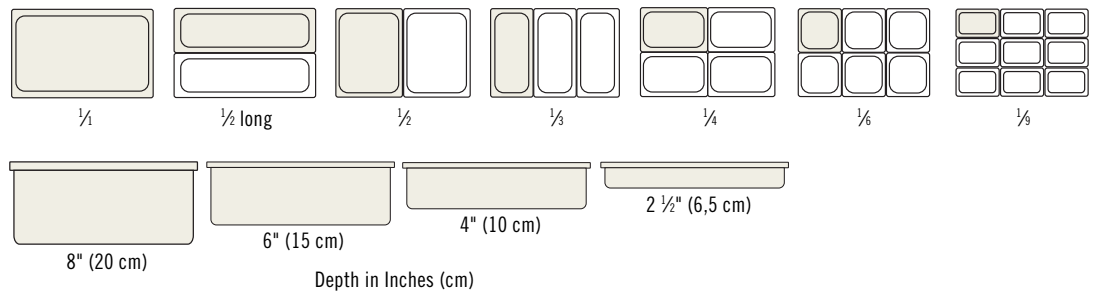



Camtherm® Electric Food Holding Cabinets

- Use to expand holding capacity in kitchen or transport large amounts of food off-site.
- Holds food safely for hours.
- Keeps cold food cold, hot food hot, moist food moist and crisp food crisp.
- Available in *hot only* and *hot/cold*, single-cavity models.
- Thick polyurethane foam insulation keeps tough polyethylene exterior cool and safe to touch.
- Uses environmentally-friendly technology with no compressor, no heating coil, and no humidifier.
- Louvered panels circulate air evenly throughout cabinet for consistent temperature and humidity throughout.
- Doors swing open flush to the sides for easy loading and unloading.
- Wide nylon latches are durable and easy to open and close.
- Door menu clips hold routing instructions, content list, and dietary info or client/event details.

48%

**More
Energy
Efficient**

Than a Leading Metal Cabinet

CAMBRO
EQUIPMENT
DESIGNED FOR DURABILITY

CAMTHERM® TIME & TEMPERATURE PERFORMANCE

HOT

WARM UP TIME
From ambient to hot.

RECOVERY TIME
Time to recover to hot temperature after door is held open for 30 seconds.

TRANSPORT TIME
After reaching hot temperature, amount of time unit can be held passively / unplugged until temperature reaches 140°F (60°C).



LOW	150°F (65°C)	165°F (74°C)	150°F (65°C)	165°F (74°C)	150°F (65°C)	165°F (74°C)
Hot	33 minutes	45 minutes	2 minutes	4 minutes	5 hours	8 hours
Hot/Cold	33 minutes	45 minutes	2 minutes	4 minutes	5 hours	8 hours



TALL						
Hot Unit	30 minutes	60 minutes	1 minute	3 minutes	4 hours	8 hours
Hot/Cold Unit	45 minutes	75 minutes	1 minute	3 minutes	6 hours	8 hours

All results based on tests with 6 full-size 6" (15,2 cm) deep H-Pans™ filled with 190°F (87,7°C) hot water, covered and placed inside upper cabinet only.

COLD

COOLING TIME
From ambient to cold.

RECOVERY TIME
Time to recover to cold temperature after door is held open for 30 seconds.

TRANSPORT TIME
After reaching cold temperature, amount of time unit can be held passively / unplugged until temperature reaches 41°F (5°C).



LOW	37°F (2,8°C)	37°F (2,8°C)	37°F (2,8°C)
Hot/Cold Unit	50 minutes	4 minutes	2 hours



TALL			
Hot/Cold Unit	75 minutes	4 minutes	1 hour

All results based on tests with 6 full-size 6" (15,2 cm) deep Camwear® Food Pans filled with 34°F (1,1°C) cold water, covered and placed inside upper cabinet only.

HOT TO COLD TRANSITION TIME
Time to transition from hot 165°F (74°C) to cold 37°F (2,8°C)

COLD TO HOT TRANSITION TIME
Time to transition from cold 37°F (2,8°C) to hot 165°F (74°C)



LOW	3 hours	2 hours 30 minutes
-----	---------	--------------------



TALL	3 hours	1 hour 20 minutes
------	---------	-------------------

TAMPER-RESISTANT SECURITY PACKAGE

Engineered for tamper-resistance and durability, the security package outfits Camtherm for the rigors of even the toughest environments. Rugged, 10" (25,4 cm) rear casters offer smooth transport across indoor and outdoor surfaces.



Locking, stainless steel door latch. Factory assembled for maximum security.



Rail assembly attached to unit with security screws.

One-piece, welded rail and upright assembly available upon request.



CAMTHERM® ELECTRIC FOOD HOLDING CABINETS

Save Electricity with Camtherm!

In an independent laboratory test, Camtherm was tested against a same-capacity, leading metal cabinet for energy efficiency. Over the course of eight hours of holding, the Camtherm cabinet used 48% less electricity than a leading metal cabinet.

Total energy usage of the Camtherm Cabinet was 38% less than the metal cabinet when consumption was measured for preheating, loading, and the eight hour holding period.

Model	Total Energy Consumption Over 8 Hours
Camtherm	2.06 kilowatt hours
Metal Cabinet	3.95 kilowatt hours



Marine rail is designed for use during service, not transport.

Top marine rail on all units holds 2 full-size food pans, one sheet pan or one cutting board (CB1220).

Solar powered, digital display thermometer monitors internal cabinet temperature.

Self-ventilating cap on each cabinet door automatically releases steam and equalizes pressure, maintaining food quality.

Door swings open 270° for easy loading.

Menu clip holds routing directions or list of cabinet contents.

Ergonomic molded-in handles are at a safe height on both low and tall profile units for easy transporting, even when fully loaded.

Heavy-duty, 14 gauge electrical cord is 9' (274,3 cm) long. Wrapping hook is located on back of each cabinet for safe cord storage.

Wide, nylon door latches and magnetic door gaskets lock doors securely and create a tight seal to retain safe hot or cold food temperatures.

Non-marking, high modulus, rubber casters are strong and extremely durable, providing smooth transport of full cabinets from kitchen to serving location.



HOLDING CAPACITY LOW PROFILE (Includes 6 rail sets)



SHEET PANS

11* 18" x 26" (45,7 x 66 cm)

FULL-SIZE FOOD PANS 12" x 20" (32,5 x 53 cm)

12 2½" (6,5 cm) Deep

8 4" (10 cm) Deep

6 6" (15 cm) Deep

4 8" (20 cm) Deep

*Requires five additional rail sets.



IT'S INSULATED!

It's OK: Go Unplugged!

Polyurethane insulation keeps hot food hot and cold food cold during transport when unit is unplugged. See time & temperature chart for details.

CAMTHERM® ELECTRIC FOOD HOLDING CABINETS

Cabinet exterior stays cool during operation.

Doors swing open 270° for easy loading.

Knuckle door hinges are built to withstand the rigors of numerous door openings. Doors lift up and off the hinges easily for cleaning.

Aluminum louvers gently and evenly direct hot or cold air around the entire cabinet and contents, eliminating hot or cold spots and maintaining food quality.

Easy-to-use control panel is located on back of each unit. Includes on/off switch, hot/cold switch for hot/cold units only and a temperature control dial for hot only. Cold performing units are factory set to chill cabinet to 37°F (2,8°C).

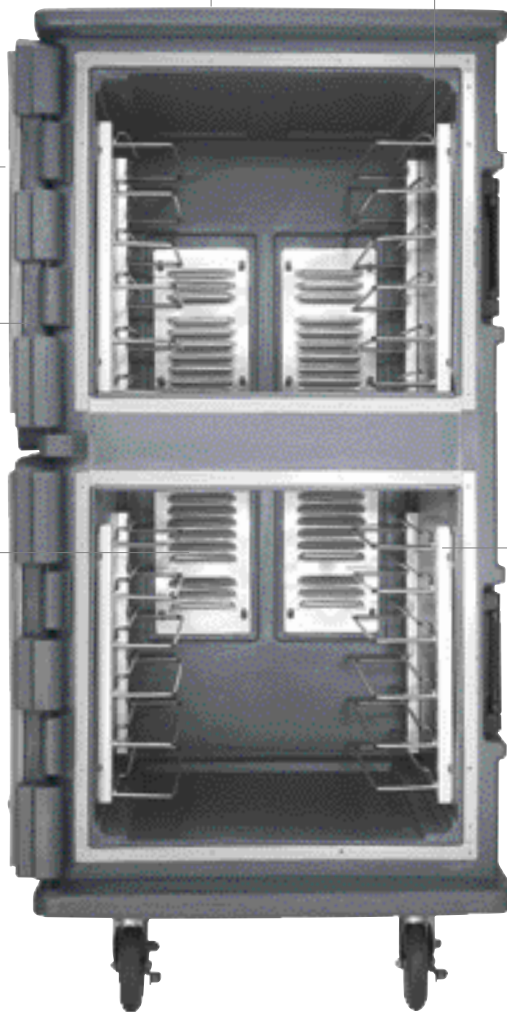

Anodized aluminum uprights and removable, adjustable chrome plated steel slide rails hold full-size food pans or sheet pans.

Tough, one-piece, seamless double-wall polyethylene exterior is easy to clean and won't dent, crack, rust, chip or break.

Energy efficient heating and/or cooling unit located on back of each cabinet. Low volt, low amp, low watt system maintains consistent hot or cold temperature and balanced humidity throughout the single cavity cabinet.

Molded-in bumpers protect walls and furniture and will never dent, chip or rust.

Assembly is covered by U.S. Patent D 442,756 S & D 6,344,630.

HOLDING CAPACITY TALL PROFILE (Includes 12 rail sets)



SHEET PANS

22** 18" x 26" (45,7 x 66 cm)

FULL-SIZE FOOD PANS 12" x 20" (32,5 x 53 cm)

24 2½" (6,5 cm) Deep

16 4" (10 cm) Deep

12 6" (15 cm) Deep

8 8" (20 cm) Deep

**Requires ten additional rail sets.



CONFORMS TO UL STD 197 & 471; ANSI/NSF STD 4

CAMTHERM COLORS:



Granite Gray (191)



Granite Green (192)



Granite Sand (194)

CAMTHERM® ELECTRICAL AND PRODUCT SPECIFICATIONS

ELECTRICAL SPECIFICATIONS





	LOW PROFILE	TALL PROFILE
Volts	110V	110V
Plug Type	Nema 5-15P	Nema 5-15P
Maximum amp draw	9.1 amps	13.7 amps
Amps run on	8.5 amps	13.2 amps
Watts	1100	1800
Hertz	50/60	50/60
Power input of heating unit	120 VAC	125 VAC

PRODUCT SPECIFICATIONS

CAD Drawings, Cut Sheets and User Manual Available at www.cambro.com.

150

	CODE	THERMOMETER	CASTERS	UNIT WEIGHT LBS.	CASE LBS. (CUBE)	LIST PRICE EA.
LOW PROFILE	EXTERIOR dimensions: W 30½" x D 42" x H 42¾"					
	Hot Only					
	CMBH1826LF	Fahrenheit	2 front 6" swivel w/brake, 2 rear 10" rigid	164	178 (32.85)	\$5,520.00
	CMBH1826LC	Celsius	2 front 6" swivel w/brake, 2 rear 10" rigid	164	178 (32.85)	5,520.00
	Hot / Cold					
	CMBHC1826LF	Fahrenheit	2 front 6" swivel w/brake, 2 rear 10" rigid	222	237 (32.85)	10,050.00
	CMBHC1826LC	Celsius	2 front 6" swivel w/brake, 2 rear 10" rigid	222	237 (32.85)	10,050.00
	LOW PROFILE WITH SECURITY PACKAGE					
	Hot Only					
	CMBH1826LTR	Fahrenheit	2 front 6" swivel w/brake, 2 rear 10" rigid	167.39	181.39 (32.85)	5,805.00
	Hot / Cold					
	CMBHC1826LTR	Fahrenheit	2 front 6" swivel w/brake, 2 rear 10" rigid	225.39	240.39 (32.85)	10,340.00
TALL PROFILE	EXTERIOR dimensions: W 30½" x D 39" x H 64¾"					
	Hot Only					
	CMBH1826TSF	Fahrenheit	2 front 6" swivel w/brake, 2 rear 6" rigid	249.64	278.64 (47.5)	\$8,840.00
	CMBH1826TBF	Fahrenheit	2 front 6" swivel w/brake, 2 rear 10" rigid	254	279.6 (47.57)	8,840.00
	CMBH1826TSC	Celsius	2 front 6" swivel w/brake, 2 rear 6" rigid	249.64	278.64 (47.5)	8,840.00
	CMBH1826TBC	Celsius	2 front 6" swivel w/brake, 2 rear 10" rigid	254	283 (47.5)	8,840.00
	Hot / Cold					
	CMBHC1826TSF	Fahrenheit	2 front 6" swivel w/brake, 2 rear 6" rigid	325.5	354.5 (47.5)	14,115.00
	CMBHC1826TBF	Fahrenheit	2 front 6" swivel w/brake, 2 rear 10" rigid	329.82	358.82 (47.5)	14,115.00
	CMBHC1826TSC	Celsius	2 front 6" swivel w/brake, 2 rear 6" rigid	325.5	354.5 (47.5)	14,115.00
	CMBHC1826TBC	Celsius	2 front 6" swivel w/brake, 2 rear 10" rigid	329.82	358.82 (47.5)	14,115.00
	TALL PROFILE WITH SECURITY PACKAGE					
	Hot Only					
	CMBH1826TTR	Fahrenheit	2 front 6" swivel w/brake, 2 rear 10" rigid	260.77	289.77 (47.5)	9,350.00
	Hot / Cold					
	CMBHC1826TTR	Fahrenheit	2 front 6" swivel w/brake, 2 rear 10" rigid	336.59	365.59 (47.5)	14,610.00
	Cabinet Colors: Granite Gray (191), Granite Green (192), Granite Sand (194).					

	CODE	DESCRIPTION	DIMENSIONS L X W X H	CASE LBS. (CUBE)	CASE PACK	PRICE EA.
ACCESSORIES	CMBR	Set of Slide Rails	20" x 4 ¹³ / ₁₆ "	2.25 (.11)	1 set of 2 Rails	\$55.00
	CB1220	Cutting Board	21" x 13 ¹ / ₈ " x 1/2"	4 (0.31)	1 each	42.00
	Cutting Board Color: White (148).		Venting plug is covered by US Patent D 553,717 S.			

COMBO CARTS™

- Use to hold full-size sheet pans or hotel pans of hot or cold food.
- Easy-to-adjust aluminum rails.
- Tough, rotationally molded polyethylene with thick foam insulation.
- Airtight removable gasket provides a secure seal.
- Doors swing open to the side of the cart for easy loading and unloading.
- Molded-in, full-length handle on the back for easy maneuvering.
- Easy to clean.

Colors: Gray (180), Dark Brown (131).

Casters: 5", 2 swivel with brakes & two 10" Wheels.

* Complete with tamper-resistant hardware for maximum security applications.

Venting plug is covered by US Patent D 553,717 S.



CMB1826L



CMB1826

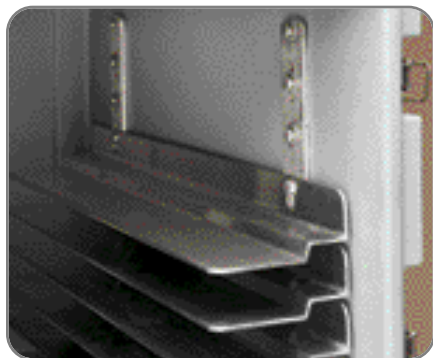

Easy-to-adjust rails hold sheet pans or full-size hotel pans (all depths).



Capacity: Holds up to 12 ea. 18" x 26" sheet pans or 24 ea. 13" x 18" sheet pans per compartment.



Capacity: Each compartment holds up to 12 ea. full size 2½" deep Food Pans (2 pans per rail).

CODE	DESCRIPTION	OVERALL DIMENSIONS W x D x H	PER CAVITY INSIDE DIMENSIONS W x D x H	CASE LBS. (CUBE)	LIST PRICE EA.
CMB1826	Combo Cart, Tall	25½" x 33⅞" x 59⅜"	22" x 26½" x 22½"	245 (34.55)	\$ 4,790.00
CMB1826L	½ Size Combo Cart, Low	25¼" x 32⅝" x 37⅞"	22" x 26½" x 22½"	144 (19.82)	2,920.00
CMB1826SP*	Combo Cart with Security Hardware	25½" x 33⅞" x 59⅜"	22" x 26½" x 22½"	245 (34.55)	5,345.00
CMB1826LSP*	½ Size Combo Cart with Security Hardware	25¼" x 32⅝" x 37⅞"	22" x 26½" x 22½"	144 (19.82)	3,195.00

Case Pack: 1

CAMCARTS®

- Use to hold hot or cold bulk food stored on trays, sheet pans or in food boxes.
- Durable polyethylene and thick foam insulation retain safe food temperatures.
- Sturdy plastic, rust-proof latches are secured into molded-in mounting plates.
- Molded-in handle on the back for easy maneuvering.



Colors: Slate Blue (401), Coffee Beige (157), Dark Brown (131), Gray (180), Brick Red (402).

6" Casters: 2 fixed, 2 swivel, 1 with brake.

Note: Cool metal sheet pans to 250°F before placing onto tray supports.

Venting plug is covered by US Patent D 553,717 S.

Only 1826DBC is NSF Listed.

1826DTC Double Cavity Cart for Trays and Sheet Pans

Capacity: 24 tray support rails on 1¹³/₁₆" centers (12 per cavity).
Holds up to 24 each 18" x 26" (46 x 66 cm) trays or sheet pans.

1826DBC Double Cavity Cart for Food Storage Boxes

Capacity: 26 support rails on 1¹/₄" centers (13 per cavity).
Holds 18" x 26" (46 x 66 cm) Food Storage Boxes.

Camcart with Security Package

Specially designed for high security applications, with tamper-resistant hardware: metal hinges with non-removeable pins, metal latches with welded bails, lockable hasp and no chassis plate.



Caster Impact Plates

Impact plates add metal reinforcement to hold casters in place even when dropped.

CODE	DESCRIPTION	EXTERIOR DIMENSIONS D* x W x H	INTERIOR DIMENSIONS D x W x H	CASE LBS. (CUBE)	LIST PRICE EA.
1826DTC	For trays & sheet pans	33 ³ / ₄ " x 21 ¹ / ₂ " x 63 ³ / ₄ "	26 ¹ / ₂ " x 18 ¹ / ₄ " x 25 ¹ / ₁₆ "	135 (27.92)	\$ 2,165.00
1826DBC	For food storage boxes	33 ³ / ₄ " x 21 ¹ / ₂ " x 63 ³ / ₄ "	26 ¹ / ₂ " x 18 ³ / ₃₂ " x 25 ¹ / ₁₆ "	135.50 (28.35)	2,165.00

Camcarts with Security Package

1826DTCSP	For trays & sheet pans	33 ³ / ₄ " x 21 ¹ / ₂ " x 63 ³ / ₄ "	26 ¹ / ₂ " x 18 ¹ / ₄ " x 25 ¹ / ₁₆ "	135 (27.92)	2,690.00
1826DBCSP	For food storage boxes	33 ³ / ₄ " x 21 ¹ / ₂ " x 63 ³ / ₄ "	26 ¹ / ₂ " x 18 ³ / ₃₂ " x 25 ¹ / ₁₆ "	143.8 (27.99)	2,670.00

Case Pack: 1 *Depth measurement includes handle.

CAMCARRIER® & CAMCARTS® – Single Compartment Models



1318MTC

Camcarrier for Half-size Sheet Pans, Full-size Food Pans, and Trays

- Holds up to 8 each 13" x 18" sheet pans or 3 each full-size deep food pans.
- Molded-in handles.
- Stackable for storage and transport.
- Fits CD300 Camdolly.



1826LBC

Camcart for Food Storage Boxes

- Holds 18" x 26" Food Storage Boxes.
- 13 supports on 1¾" centers.
- Includes removable cutting board on top.



1826MTC

Camcarrier for Trays and Sheet Pans

- Holds up to 6 each 18" x 26" sheet pans.
- Six tray supports on 2½" centers.
- Molded-in handles
- Fits CD1826MTC Camdolly.



1826LTC3

Camcart for Trays and Sheet Pans

- Holds up to 7 each 18" x 26" trays or sheet pans.
- Seven tray supports on 3¾" centers for 3" clearance between trays.
- Includes removable cutting board on top.



1826LTCSP

Camcart with Security Package

- Specially designed for high security applications.
- Features tamper-resistant hardware to protect both cart and contents.
- Includes removable cutting board on top.



1826LTC

Camcart for Trays and Sheet Pans

- Holds up to 13 each 18" x 26" trays or sheet pans.
- Thirteen tray supports on 1¾" centers.
- Includes removable cutting board on top.

Colors: Slate Blue (401), Gray (180), Coffee Beige (157), Dark Brown (131), Navy Blue (186).

1826MTC is available in Black (110).
1318MTC not available in Gray (180).

Strap Color: Beige (000).

See Camdolly® section for pricing, color and ordering information.

CD1826MTC: 5" Casters: 2 fixed, 2 swivel, 1 with brake.

CD1826MTCCHB: 5" Casters: 2 swivel, 1 with brake and 2, 10" Easy Wheels.

* With handle.

** Cart comes complete with tamper-resistant hardware for maximum security applications.

6" Casters: 2 fixed, 2 swivel, 1 with brake.

Note: Cool metal sheet pans to 250°F before placing onto tray supports.



CODE	DESCRIPTION	EXTERIOR DIMENSIONS D* x W x H	INTERIOR DIMENSIONS D x W x H	CASE LBS. (CUBE)	LIST PRICE EA.
1318MTC	For trays & ½ size sheet pans	16½" x 24" x 23⅜"	13⅜" x 21" x 14"	31.50 (5.74)	\$ 455.00
1826MTC	For trays & sheet pans	29¼" x 21½" x 22½"	26⅞" x 18⅜" x 13¼"	41.33 (8.67)	\$ 680.00
Camdolly					
CD1826MTC	Camdolly for 1826MTC	35⅞" x 23⅜" x 35¾"	28½" x 22"	35 (17.40)	510.00
CD1826MTCCHB	Camdolly with Easy Wheels for 1826MTC	34⅞" x 27½" x 36¾"	28⅞" x 21⅞"	41.8 (21.43)	645.00
Camcarts					
1826LTC	For trays & sheet pans	32" x 21½" x 37½"	26⅞" x 18⅜" x 26¼"	86 (16.39)	1,305.00
1826LTC3	For trays & sheet pans	32" x 21½" x 37½"	26⅞" x 18⅜" x 26¼"	86 (16.39)	1,305.00
1826LBC	For Food Storage Boxes	32" x 21½" x 37½"	26⅞" x 18⅜" x 26¼"	86 (16.39)	1,295.00
Camcarts with Security Package**					
1826LTCSP	For trays & sheet pans	32" x 21½" x 37½"	26⅞" x 18⅜" x 26¼"	86 (16.39)	1,535.00
1826LBCSP	For Food Storage Boxes	32" x 21½" x 37½"	26⅞" x 18⅜" x 26¼"	86 (16.39)	1,510.00
Securing Strap					
1826STP	Securing Strap	142" L	—	4.80 (0.58)	90.00

Case Pack: 1 Venting plug is covered by U.S. Patent D 553,717S.

BEVERAGE SERVICE CART

- Ideal for breakfast, coffee or snack service.
- Use top counter to hold Cambro Beverage Servers, Versa Organizer Bins or Display Trays with Covers for food.
- Store drinkware, additional food items or other supplies in open compartment.
- Insulated cabinets hold hot or cold food in full, 1/2 or 1/3 size food pans or on Cambro Metric Camtrays (3253).

Colors: Slate Blue (401), Granite Gray (191), Granite Green (192).

See Organizer section for more information on Organizer Bins.

See Beverage Server section for more information.

Wire Rack Color: Silver (000).

6" Casters: 2 fixed, 2 swivel, 1 with brake.

* Not NSF listed.



Beverage Service Cart is designed to hold Beverage Containers at point of service only. A dolly or hand truck with safety strap is recommended for moving Beverage Containers over longer distances or uneven surfaces.



MDC24F
Shown in Granite Gray (191)



MDC24, shown in Granite Green (192), has recessed top that holds 3 each 1 gallon Camtainers and stacked Condiment Bins & Wire Rack with 3253 trays.

CODE	EXTERIOR DIMENSIONS L x W x H	CASE PACK	CASE LBS. (CUBE)	LIST PRICE EA.
MDC24F	44½" x 30" x 44"	1	133 (37.82)	\$ 2,200.00
MDC24	44½" x 30" x 44"	1	133 (37.82)	2,200.00

OPTIONAL ACCESSORIES

Organizer Bin

5412CBP	12" x 5" x 4¼"	12	7.84 (1.78)	8.40
---------	----------------	----	-------------	------

Camtainer

100LCD	10⅝" x 11¾" x 17¼"	1	9.50 (1.24)	200.00
--------	--------------------	---	-------------	--------

Wire Rack

MDC24R	23" x 17" x 14"	1	15 (3.36)	140.00
--------	-----------------	---	-----------	--------

Camchiller

CP1220	20⅜" x 12⅞" x 1½"	1	11 (0.38)	120.00
--------	-------------------	---	-----------	--------

The use of racks in the MDC24 and MDC24F carts will allow the following configuration of pans or trays, per compartment:

DESCRIPTION	FULL (1/1)	HALF (1/2)	THIRD (1/3)
2½" Pans	(4) 12CW	(8) 22CW	(12) 32CW
4" Pans	(3) 14CW	(6) 24CW	(9) 34CW
6" Pans	(2) 16CW	(4) 26CW	(6) 36CW
8" Pans	(1) 18CW**	(2) 28CW**	(3) 38CW**
Metric Camtrays®	(10) 3253		

** with room for 2½" or 4" pan above 8" pan.

Compartment dimensions:

Shelf Compartment:	W 37 15/16"	D 25 1/8"	H 10"
Holding Compartments:	W 17 1/16"	D 23 3/8"	H 14 1/8"

Venting plug is covered by U.S. Patent D 553,717S.

MDC24R Wire Rack

Wire Rack (sold separately) to organize pans and trays in the cart. Rack holds Full, 1/2 and 1/3 size Food Pans and 3253 trays. When placed in cart's holding compartment, the rack allows room on either sides for CP1220 Camchillers.®



MEAL DELIVERY CARTS FOR TRAY SERVICE

Marine rail is designed for use during service, not transport.



MDC1418S20



MDC1418T30

MEAL DELIVERY CARTS FOR TRAY SERVICE (20 Tray Capacity)

- Use to transport meal trays from the kitchen to acute care patients, nursing home residents or correctional facility inmates.
- Ensures optimal food quality and short delivery times.
- Rail spacing holds all standard tray set-ups with clearances up to 5½" (14 cm) high.
- Made of tough, one-piece, double-wall polyethylene.
- Easy to clean and won't rust, dent, crack, chip or break.
- Tall profile units have light-weight non-insulated ABS doors. Low profile units have insulated polyethylene doors.

MDC1520T16 and MDC1418T16 are covered by U.S. Patent D 398,727.
 MDC1520T30, MDC1418T30 and MDC1418S20 Patent Pending.



See Meal Delivery products in Table Service Section.

Marine rail is designed for use during service, not transport.



LOW PROFILE

SPECIFICATIONS	MDC1520S20 FORMERLY MDC1520	MDC1418S20
TRAY SIZE	15" x 20"	14" x 18"
TRAYS PER CART / PER COMPARTMENT	20 / 10	20 / 10
RAILS PER COMPARTMENT	5	5
TRAYS PER RAIL / RAIL SPACING	2 / 5½"	2 / 5½"
NUMBER OF COMPARTMENTS	2	2
NUMBER OF MENU CLIPS	2	2
MENU CLIPS - LOCATION	1 per door	1 per door
HANDLES - TYPE AND LOCATION	Molded in, each end	Molded in, each end
CASTER TYPE	5", 2 end swivel w/brake; 8", 2 rigid on center axle	5", 2 swivel w/brake, 2 rigid, offset
LATCHES	2 internal nylon friction	2 internal nylon friction, 1 external lock hook
EXTERNAL DIMENSIONS W x D x H	55½" x 38" x 43¼"	48½" x 32½" x 44"
INTERNAL DIMENSIONS W x D x H	20½" x 30¼" x 27½"	18¾" x 28¾" x 29"
REQUIRED DOOR WIDTH	38½"	33"
UNIT WEIGHT LBS	160 lbs.	151 lbs.
CASE LBS. (CUBE)	165.2 (55.7)	160.4 (41.53)
LIST PRICE EACH	\$ 3,015.00	\$ 2,950.00

Case Pack: 1 Colors: Gray (180), Slate Blue (401), Granite Gray (191), Granite Green (192), Granite Sand (194).

MEAL DELIVERY CARTS FOR TRAY SERVICE (16 & 30 Tray Capacity)



MDC1520T30



MDC1520T30

Marine rail is designed for use during service, not transport.



MDC1418T30



MDC1418T30

TALL PROFILE

SPECIFICATIONS	MDC1520T30	MDC1418T30	MDC1520T16	MDC1418T16
TRAY SIZE	15" x 20"	14" x 18"	15" x 20"	14" x 18"
TRAYS PER CART / COMPARTMENT	30 / 10	30 / 10	16 / 8	16 / 8
RAILS PER COMPARTMENT	10	10	4	4
TRAYS PER RAIL / RAIL SPACING	1 / 5"	1 / 5"	2 / 5¼"	2 / 5¼"
NUMBER OF COMPARTMENTS	3	3	2	2
NUMBER OF MENU CLIPS	5	5	1	1
MENU CLIPS - LOCATION	Each door, each end	Each door, each end	Back of cart only	Back of cart only
HANDLES - TYPE AND LOCATION	Heavy-duty nylon, mounted 1 per end	Heavy-duty nylon, mounted 1 per end	Molded-in, back of cart	Molded-in, back of cart
CASTER TYPE	6", 2 rigid, 4 swivel w/brake, offset	6", 2 rigid, 4 swivel w/brake, offset	6", 2 rigid, 2 swivel w/brake	6", 2 rigid, 2 swivel w/brake
LATCHES	Friction catch, Transit latches*	Friction catch, Transit latches*	Large paddle latch	Large paddle latch
EXTERNAL DIMENSIONS W x D x H	60" x 29¼" x 63¾"	60" x 29¼" x 63¾"	30¾" x 39¾" x 58¾"	28" x 36½" x 58¾"
INTERNAL DIMENSIONS W x D x H	15¼" x 21" x 50"	14½" x 21½" x 50"	20¾" x 30½" x 21½"	18¾" x 29¾" x 21½"
REQUIRED DOOR WIDTH	30"	30"	31"	28½"
UNIT WEIGHT LBS	224 lbs.	228 lbs.	148 lbs.	128 lbs.
CASE LBS. / CASE CUBE	234 / 70.67	278 / 65.5	167.7 / 45.87	140.67 / 39.44
LIST PRICE EACH	\$ 5,330.00	\$ 5,275.00	\$3,065.00	\$ 2,985.00

Case Pack: 1 Cart Colors (All carts with Cream color doors): Gray (180), Slate Blue (401), Granite Gray (191), Granite Green (192), Granite Sand (194). *Stainless steel transit latch at top of each door. For lighter-duty applications, 30-tray carts may be ordered without the steel transit latches by using product code MDC1520T30NL or MDC1418T30NL.

MEAL DELIVERY CARTS FOR TRAY SERVICE

Latches

Tall Profile Units, 30 Trays MDC1520T30, MDC1418T30

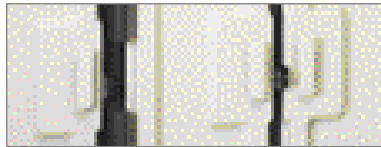

Hidden friction catch on each door for easy closing.

Tall Profile Units, 16 Trays MDC1520T16, MDC1418T16

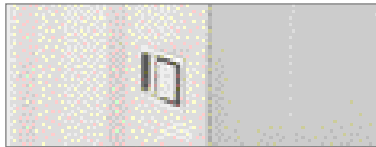

Large stainless steel paddle latches are easy to open, rust free and removable for easy cleaning.

Low Profile Units, 20 Trays MDC1520S20, MDC1418S20



Internal friction catch on each door. External stainless steel hooks to lock contents.

Handles

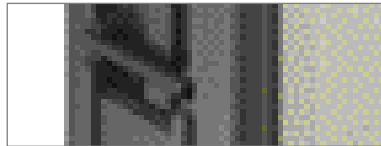

Heavy-duty nylon handles are securely mounted and nested into each end.



Molded in handles for easy transporting.



Molded in handles on each end for smooth transporting.

Casters

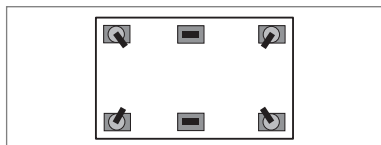

Four swivel, corner casters are slightly offset to keep cart stable on uneven surfaces, while two fixed, center casters provide a tighter turning radius.



Rigid casters on front and swivel on the back offer solid stability and easy maneuvering.



MDC1520S20 MDC1418S20
Two caster configurations offer excellent stability and smooth transporting.

MEAL DELIVERY CART - FOR CORRECTIONAL TRAY SERVICE

Modified for use in correctional facilities. Holds 60 each 1411CW or 1411CP Cambro Base Trays with 853 Insert Trays or 60 each 10146DCW or 10146DCP Separator Compartment Trays. Security features include handle security screws, lock blocks on phenolic casters.



SPECIFICATIONS	MDC1411T60
TRAY SIZE	14" x 11" Base Tray 1411CW and 1411CP
TRAYS PER CART / PER COMPARTMENT	60 / 20
RAILS PER COMPARTMENT	10
TRAYS PER RAIL / RAIL SPACING	2 / 5"
NUMBER OF COMPARTMENTS	3
MENU CLIPS	None
HANDLES - TYPE AND LOCATION	Heavy-duty aluminum with security screws, black finish, 1 per end
CASTER TYPE	6" phenolic heavy-duty casters, 2" wide tread, 2 swivel no brake, 2 rigid
LATCHES	Internal friction catch, 2 per door, transit latch*
EXTERNAL DIMENSIONS W x D x H	60" x 29¼" x 63¾"
INTERNAL DIMENSIONS W x D x H	14½" x 21½" x 50"
REQUIRED DOOR WIDTH	30"
UNIT WEIGHT LBS	228 lbs.
CASE LBS. / CASE CUBE	278 / 65.5
LIST PRICE EACH	\$ 5,275.00

Case Pack: 1 Colors: See colors listed with Meal Delivery Cart, Tall Profile.
*Stainless steel transit latch at top of each door.

CAMRACK® WAREWASHING & STORAGE SYSTEM

Tray and Dish Cart

Tray and Silver Cart

Dish Caddies

Service Carts

Utility Carts

Cambox® Bussing
Boxes & Covers

Camdollies®

Camracks

Camrack Personalization



CAMBRO
EQUIPMENT
DESIGNED FOR DURABILITY

Consultant Cut Sheets and
CAD drawings are available on
www.cambro.com





KD SERVICE CART AND KD UTILITY CART

- Versatile, durable and economically-priced carts.
- Marine rails and lightly-textured polypropylene shelves keep contents in place.
- Aluminum uprights ensure stability.
- Ships “knocked down” to minimize shipping costs.
- Easy to assemble.

Cart and Shelf Panel Set Colors:
Black (110), Speckled Gray (480).

Trash Container and Silverware Holder Color: Black (110).



Each BC340KD shelf holds one full-sized dish rack or two standard bus boxes

Optional shelf panels can be added at time of assembly to enclose three sides

Marine rails keep contents in place

Sturdy aluminum uprights

Four powder coated steel swivel casters provide quiet transport and steady maneuvering

BC340KD

Durable, stain-resistant surface is easy to clean



BC331KD

CODE	BC340KD	BC331KD
DESCRIPTION	Utility Cart	Service Cart
CASTER DIA./TYPE	5", 4 swivel, no brake	4", 4 swivel, no brake
OVERALL DIM. L x D x H	40" x 21¼" x 37½"	32⅞" x 16¼" x 38"
SHELF DIM. L x D x H	31½" x 20½" x 11¾"	24⅞" x 15⅞" x 11¼"
LOAD CAPACITY	400 lbs.	300 lbs.
CASE LBS. (CUBE)	39 (6.72)	24.01 (4.07)
LIST PRICE EACH	\$ 292.00	\$ 196.00

Case Pack: 1

InStock Colors: Black (110), Speckled Gray (480).

Optional Accessories



CODE	BC331KDTC	BC331KDSD	BC340KDP
DESCRIPTION	8 gal. Trash Container	2.5 gal. Silverware Holder	Single Shelf Panel Set (for KD Utility Cart Only)
DIM. W x D x H	13" x 9½" x 22"	13" x 9½" x 7¼"	31⅞" x 17¼" x 11¼"
CASE LBS. (CUBE)	4.96 (1.92)	2.25 (0.59)	6.25 lbs (0.65)
LIST PRICE EACH	\$ 80.00	\$ 46.00	\$ 80.00

Case Pack: 1

SERVICE CARTS

- All-purpose versatile, durable and dependable workhorses.
- Ideal for use on the receiving dock or setting up and bussing tables.
- Made of one-piece, polyethylene with molded-in handles and shelves.
- Choose from models with open or enclosed sides.

Colors: Black (110), Slate Blue (401), Dark Brown (131), Coffee Beige (157), Gray (180), Granite Gray (191), Granite Green (192).

BC225, BC2254S, BC11TC and BC1115SH can be shipped by parcel carrier.



Open Carts



CODE	BC225	BC2254S	BC235
CASTER DIA./TYPE	3", 2 fixed, 2 swivel, 1 w/brake	3", 4 swivel, 1 w/brake	5", 2 fixed, 2 swivel, 1 w/brake
OVERALL DIM. L x D x H	28" x 16" x 32 1/4"	28" x 16" x 32 1/4"	37 1/4" x 21 1/2" x 34 5/8"
SHELF DIM. L x D x H	21 3/4" x 15 1/2" x 11 1/4"	21 3/4" x 15 1/2" x 11 1/4"	31 1/2" x 20 3/8" x 11 1/4"
LOAD CAPACITY	350 lbs.	350 lbs.	500 lbs.
CASE LBS. (CUBE)	41 (9.2)	38.8 (9.2)	63.33 (17.63)
LIST PRICE EACH	\$ 510.00	\$ 525.00	\$ 700.00

Case Pack: 1



CODE	BC2354S	BC230	BC2304S
CASTER DIA./TYPE	5", 4 swivel, 1 w/brake	5", 2 fixed, 2 swivel, 1 w/brake	5", 4 swivel, 1 w/brake
OVERALL DIM. L x D x H	37 1/4" x 21 1/2" x 34 5/8"	33 3/4" x 20" x 34 5/8"	33 3/4" x 20" x 34 5/8"
SHELF DIM. L x D x H	31 1/2" x 20 3/8" x 11 1/4"	27" x 19 1/2" x 11 1/4"	27" x 19 1/2" x 11 1/4"
LOAD CAPACITY	500 lbs.	500 lbs.	500 lbs.
CASE LBS. (CUBE)	68 (17.85)	62 (15.13)	57.4 (14.77)
LIST PRICE EACH	\$ 710.00	\$ 645.00	\$ 655.00

Case Pack: 1

Enclosed Carts



CODE	BC330	BC3304S
CASTER DIA./TYPE	5", 2 fixed, 2 swivel, 1 w/brake	5", 4 swivel, 1 w/brake
OVERALL DIM. L x D x H	33 3/8" x 20" x 34 5/8"	33 3/8" x 20" x 34 5/8"
SHELF DIM. L x D x H	27" x 18 1/2" x 11 1/4"	27" x 18 1/2" x 11 1/4"
LOAD CAPACITY	500 lbs.	500 lbs.
CASE LBS. (CUBE)	64.17 (14.73)	65.2 (14.87)
LIST PRICE EACH	\$ 695.00	\$ 705.00

Case Pack: 1

Optional Accessories



CODE	BC11TC*	BC1115SH*
DESCRIPTION	11 gal. Trash Container	1.75 gal. Silverware Holder
DIMENSIONS W x D x H	13 3/4" x 8 7/8" x 21 1/8"	14 1/2" x 6" x 5 3/8"
CASE LBS. (CUBE)	6 (2.1)	3.25 (0.79)
LIST PRICE EACH	\$ 75.00	\$ 70.00

Case Pack: 1

* BC11TC & BC1115SH will not fit KD Service or Utility Carts.

CAMBOX® BUS BOXES

Regal



CODE	415CBR	912CBR	1120CBR	1520CBR
DESCRIPTION	Cutlery Insert Box	Utility Box	Four Compartment Cutlery Box	15" x 20" Cambox
DIM. W x L x H	4 ⁷ / ₁₆ " x 14 ³ / ₁₆ " x 4 ¹ / ₁₆ "	9 ¹ / ₁₆ " x 12 ¹ / ₁₆ " x 5 ¹ / ₈ "	11 ³ / ₈ " x 20 ⁷ / ₁₆ " x 3 ³ / ₄ "	15 ⁵ / ₁₆ " x 19 ¹⁵ / ₁₆ " x 4 ¹⁵ / ₁₆ "
CASE LBS. (CUBE)	7 (0.77)	10.56 (1.24)	22.54 (2.65)	23 (3.54)
LIST PRICE EACH	\$ 9.15	\$ 13.15	\$ 22.55	\$ 23.10
Case Pack: 12	Colors: Black (110), Dark Brown (131).			



CODE	1621CBR	21155CBR	21157CBR	1722CBR
DESCRIPTION	16" x 21" Cambox	15" x 21" x 5" Cambox	15" x 21" x 7" Cambox	17" x 22" Cambox
DIM. W x L x H	15 ⁵ / ₈ " x 20 ¹ / ₂ " x 4 ⁷ / ₈ "	15 ¹ / ₄ " x 20 ¹ / ₄ " x 4 ¹⁵ / ₁₆ " (includes handle)	15 ¹ / ₁₆ " x 20 ³ / ₁₆ " x 6 ¹⁵ / ₁₆ "	16 ⁷ / ₈ " x 21 ¹ / ₈ " x 4 ³ / ₄ "
CASE LBS. (CUBE)	42 (3.99)	27.74 (3.94)	35.20 (4.53)	28.24 (4.15)
LIST PRICE EACH	\$ 37.05	\$ 27.05	\$ 31.20	\$ 29.95
Case Pack: 12	Colors: Black (110), Dark Brown (131).			

Poly



CODE	415CBP	912CBP	1120CBP	1520CBP	1520CBPF*
DESCRIPTION	Cutlery Box	Utility Box	11" x 20" Cambox	15" x 20" Cambox	15" x 20" Cambox
DIM. W x L x H	4 ⁷ / ₁₆ " x 14 ³ / ₁₆ " x 4 ¹ / ₈ "	9 ¹ / ₁₆ " x 12 ¹ / ₁₆ " x 5 ¹ / ₈ "	11 ³ / ₈ " x 20 ⁷ / ₁₆ " x 3 ³ / ₄ "	15 ⁵ / ₁₆ " x 19 ¹⁵ / ₁₆ " x 4 ¹⁵ / ₁₆ "	15 ⁵ / ₁₆ " x 19 ¹⁵ / ₁₆ " x 4 ¹⁵ / ₁₆ "
CASE LBS. (CUBE)	2.6 (0.75)	9.25 (1.22)	20 ¹ / ₂ (2.59)	18.61 (3.29)	20.5 (3.54)
LIST PRICE EACH	\$ 7.00	\$ 9.50	\$ 15.20	\$ 15.70	\$ 15.70
Case Pack: 12	Colors: Black (110), Dark Brown (131), Light Gray (180). InStock Color: Light Gray (180). *1520CBPF is identical to 1520CBP except the internal surface is flat.				



CODE	1621CBP	21155CBP	21157CBP	1722CBP
DESCRIPTION	15" x 20" Cambox	15" x 21" x 5" Cambox	15" x 21" x 7" Cambox	17" x 22" Cambox
DIM. W x L x H	15 ⁵ / ₈ " x 20 ¹ / ₂ " x 4 ⁷ / ₈ "	15 ¹ / ₄ " x 20 ¹ / ₄ " x 4 ¹⁵ / ₁₆ " (includes handle)	15 ¹ / ₁₆ " x 20 ³ / ₁₆ " x 6 ¹⁵ / ₁₆ "	16 ⁷ / ₈ " x 21 ¹ / ₈ " x 4 ³ / ₄ "
CASE LBS. (CUBE)	31.20 (3.89)	21.41 (3.20)	25 (3.73)	26 (4.20)
LIST PRICE EACH	\$ 23.75	\$ 17.70	\$ 19.10	\$ 19.10
Case Pack: 12	Colors: Black (110), Dark Brown (131), Light Gray (180). InStock Color: Light Gray (180).			

Covers



CODE	1520CBCP	1722CBCP	2115CBCP	2115CBR
FITS	1520CBP, 1520CBPF 15 x 20 Cambox, Poly	1722CBR, 1722CBP 17 x 22 Cambox, Regal & Poly	21155CBP, 21157CBP 15 x 20 Cambox, Poly	21155CBR, 21157CBR 15 x 20 Cambox, Regal
DIM. W x L	16" x 20 ¹ / ₂ "	17 ¹ / ₁₆ " x 22 ¹ / ₈ "	15 ¹ / ₂ " x 20 ¹ / ₂ "	15 ¹ / ₂ " x 20 ¹ / ₂ "
CASE LBS. (CUBE)	13.08 (1.17)	13.36 (0.93)	12.75 (1.38)	17 (1.40)
LIST PRICE EACH	\$ 12.75	\$ 23.00	\$ 12.70	\$ 13.20
Case Pack: 12	Color: White (148).			

CAMDOLLIES®

- Use to transport anything from stacks of sheet pans to catering equipment.
- Reduce employee lifting and carrying, reducing possible injury.
- Made of extremely durable plastic that will not dent, crack, rust or corrode.
- Heavy-duty casters maneuver easily over all types of terrain.
- For heavy transport needs, select models with handles and rear Big Wheels.

Colors: Coffee Beige (157), Dark Brown (131), Black (110), Slate Blue (401), Gray (180).
CDR2020, CDR2020H Color: Soft Gray (151).

Caster Type

- A:** 5" Casters: 2 fixed, 2 swivel, 1 with brake.
B: 3" Casters: 4 swivel, no brakes.
C: 10" Rear Big Wheels, 2 front 5" swivel casters, 1 with brake.
D: 3½" Casters: 4 swivel, no brakes.

Available Parcel Carrier Delivery:

CDR2020, CDR2020H, CD2020, CD1420, CD2028, CD1313, CD1327, CD100, CD160, CD200, CD300, CD400, CD1826PDB, 203OUT & 400STP.



For 18" x 26" Trays and Sheet Pans

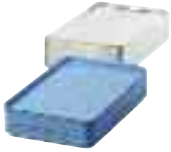

CODE	CD1826H	CD1826HB
LOAD CAPACITY	300 lbs.	300 lbs.
CASTER TYPE	A	C
EXTERNAL DIMENSIONS W x D x H	20⅞" x 31½" x 38½"	23⅜" x 33½" x 36½"
INTERIOR DIMENSIONS W x D	18½" x 26⅞"	18½" x 26⅞"
CASE LBS. (CUBE)	33.75 (12.82)	47 (18.29)
LIST PRICE EACH	\$ 470.00	\$ 590.00

Case Pack: 1

For Dish Racks



CODE	CDR2020*	CDR2020H*	CD2020	CD2020H	CD2020HB
LOAD CAPACITY	350 lbs.	350 lbs.	300 lbs.	350 lbs.	350 lbs.
CASTER TYPE	D	D	B	B	C
EXTERNAL DIMENSIONS W x D x H	21⅜" x 21⅜" x 8"	21⅜" x 23⅜" x 37"	22½" x 22½" x 8⅞"	22⅜" x 24⅜" x 36¾"	26" x 26⅞" x 36⅞"
INTERIOR DIMENSIONS W x D	20⅞" x 20⅞"	20⅞" x 20⅞"	20⅞" x 20⅞"	20⅞" x 20⅞"	20½" x 20⅞"
CASE LBS. (CUBE)	11.75 (1.14)	21.5 (3.25)	16.82 (2.68)	32.25 (11.45)	46 (15.89)
LIST PRICE EACH	\$ 160.00	\$ 260.00	\$ 255.00	\$ 410.00	\$ 535.00

Case Pack: 1

InStock Color: Soft Gray (151). * Not NSF listed.

For Milk Crates and #10 Can Cases



CODE	CD1420	CD2028
HOLDS 14" X 19" MILK CRATES	YES	YES
HOLDS #10 CAN CASES	YES	YES
LOAD CAPACITY	350 lbs.	350 lbs.
CASTER TYPE	B	B
EXTERNAL DIMENSIONS W x D x H	16⅞" x 21⅜" x 8"	21⅜" x 30¼" x 8"
INTERIOR DIMENSIONS W x D	13⅜" x 19⅜"	19⅞" x 27⅞"
CASE LBS. (CUBE)	15.25 (1.44)	18.8 (3.28)
LIST PRICE EACH	\$ 250.00	\$ 265.00

Case Pack: 1

CODE	CD1313	CD1327
HOLDS 13" X 13" MILK CRATES	YES	YES
HOLDS #10 CAN CASES	NO	YES
LOAD CAPACITY	250 lbs.	300 lbs.
CASTER TYPE	B	B
EXTERNAL DIMENSIONS W x D x H	16⅞" x 16⅞" x 8⅞"	16⅞" x 29¼" x 8⅞"
INTERIOR DIMENSIONS W x D	13⅜" x 13⅜"	13⅜" x 26¾"
CASE LBS. (CUBE)	12.3 (1.11)	14.97 (2.54)
LIST PRICE EACH	\$ 235.00	\$ 250.00

Case Pack: 1

CAMDOLLIES®

For Camcarriers® and Camtainers®



CODE	CD100	CD100H	CD100HB
HOLDS CAMCARRIERS	100MPC, UPC100, UPC101	100MPC	100MPC, UPC100, UPC101
HOLDS CAMTAINERS	UC250, UC500, 250LCD, 350LCD, 500LCD	UC250, UC500, 250LCD, 350LCD, 500LCD	UC250, UC500, 250LCD, 350LCD, 500LCD
LOAD CAPACITY	300 lbs.	350 lbs.	350 lbs.
CASTER TYPE	A	A	C
EXTERNAL DIMENSIONS W x D x H	19 ⁹ / ₈ " x 28 ³ / ₈ " x 10 ¹ / ₂ "	19 ³ / ₄ " x 33 ¹ / ₈ " x 36 ¹ / ₄ "	23 ¹ / ₂ " x 32 ¹ / ₈ " x 36 ¹ / ₂ "
INTERIOR DIMENSIONS W x D	17 ¹ / ₄ " x 26 ³ / ₁₆ "	17 ³ / ₄ " x 26 ³ / ₁₆ "	17 ¹ / ₂ " x 26 ³ / ₈ "
CASE LBS. (CUBE)	17.5 (3.33)	33.8 (12.71)	45 (18.51)
LIST PRICE EACH	\$ 280.00	\$ 450.00	\$ 545.00

Case Pack: 1

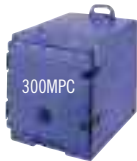

CODE	CD160	CD300
HOLDS CAMCARRIERS	125MPC, UPC140, UPC160, UPC180 UPCS140, UPCS160, UPCS180, UPSS160	300MPC, 1318MTC
HOLDS CAMTAINERS	—	UC1000, 1000LCD
LOAD CAPACITY	300 lbs.	300 lbs.
CASTER TYPE	A	A
EXTERNAL DIMENSIONS W x D x H	16 ⁷ / ₁₆ " x 24 ³ / ₈ " x 10 ³ / ₈ "	19 ³ / ₈ " x 25 ⁵ / ₈ " x 10 ³ / ₈ "
INTERIOR DIMENSIONS W x D	14 ¹ / ₁₆ " x 21 ¹⁵ / ₁₆ "	16 ¹⁵ / ₁₆ " x 23 ³ / ₁₆ "
CASE LBS. (CUBE)	19 (2.30)	17.5 (3.27)
LIST PRICE EACH	\$ 280.00	\$ 280.00

Case Pack: 1

InStock Color: Black (110).



CODE	CD300H	CD300HB	CD400 (Shown with Optional Strap)
HOLDS CAMCARRIERS	300MPC, 1318MTC	300MPC, 1318MTC	UPC400, UPCS400, UPCH400
HOLDS CAMTAINERS	UC1000, 1000LCD	UC1000, 1000LCD	—
LOAD CAPACITY	350 lbs.	350 lbs.	300 lbs.
CASTER TYPE	A	C	A
EXTERNAL DIMENSIONS W x D x H	19" x 30 ³ / ₈ " x 36 ¹ / ₄ "	23 ¹ / ₂ " x 29 ³ / ₈ " x 36 ¹ / ₂ "	20 ³ / ₄ " x 27 ³ / ₈ " x 9"
INTERIOR DIMENSIONS W x D	16 ¹⁵ / ₁₆ " x 23 ³ / ₁₆ "	17 ¹ / ₄ " x 23 ⁵ / ₈ "	18 ¹ / ₈ " x 25"
CASE LBS. (CUBE)	33 (12.07)	46 (18.11)	19.60 (3.35)
LIST PRICE EACH	\$ 445.00	\$ 535.00	\$ 310.00

Case Pack: 1

InStock Color: Black (110).

CAMDOLLIES® & UTILITY TRUCKS

For Camcarriers®



For Pizza Dough Boxes

See Pizza Dough Boxes page



CODE	CD1826MTC	CD1826MTCHB
HOLDS CAMCARRIER	1826MTC	1826MTC
LOAD CAPACITY	350 lbs.	350 lbs.
CASTER TYPE	A	C
EXTERNAL DIMENSIONS W x D x H	23 ¹⁵ / ₁₆ " x 35 ¹ / ₈ " x 36 ¹ / ₂ "	27 ¹ / ₂ " x 34 ⁷ / ₈ " x 36 ³ / ₄ "
INTERIOR DIMENSIONS W x D	22" x 28 ¹ / ₂ "	21 ⁷ / ₈ " x 28 ⁵ / ₁₆ "
CASE LBS. (CUBE)	35 (17.40)	41.8 (21.43)
LIST PRICE EACH	\$ 510.00	\$ 645.00

Case Pack: 1

CD1826PDB (Optional Strap Available)
DB18263CW, DB18266CW, DB18263P
300 lbs.
A
19 ⁷ / ₈ " x 27 ⁷ / ₈ " x 10 ¹ / ₄ "
17 ¹ / ₁₆ " x 25 ³ / ₈ "
22 (3.67)
\$ 315.00

Case Pack: 1

Utility Trucks

- Use for transporting loads of up to 600 lbs.
- Large platforms for convenient loading and built-in handles for easy maneuvering.
- All models feature 5" (12,7 cm) heavy-duty casters bolted into molded-in metal backing plates.

Colors: Coffee Beige (157), Dark Brown (131), Black (110), Slate Blue (401), Gray (180), Brick Red (402), Green (519).

Castors: 5", 2 fixed, 2 swivel, 1 with brake.



CODE	2030UT (with chrome handle)	2436UTH	2436UTHS (Includes two straps)
LOAD CAPACITY	600 lbs.	600 lbs.	600 lbs.
EXTERNAL DIMENSIONS W x D x H	19 ³ / ₄ " x 32 ⁵ / ₈ " x 38 ¹ / ₂ "	23 ³ / ₄ " x 41 ⁵ / ₈ " x 36 ¹ / ₄ "	23 ³ / ₄ " x 41 ⁵ / ₈ " x 36 ¹ / ₄ "
LOAD PLATFORM	19 ³ / ₄ " x 29 ⁵ / ₈ "	23 ³ / ₄ " x 35 ¹³ / ₁₆ "	23 ³ / ₄ " x 35 ¹³ / ₁₆ "
CASE LBS. (CUBE)	31 (3.29)	45 (22.93)	46 (22.93)
LIST PRICE EACH	\$ 640.00	\$ 600.00	\$ 640.00

Case Pack: 1

Camdolly® Strap for CD400 and CD1826PDB Camdollies

CODE	400STP
CASE LBS. (CUBE)	1.22 (.11)
LIST PRICE EACH	\$ 15.00

Case Pack: 1



TRAY & DISH CART / TRAY & SILVER CART

Tray & Dish Cart

- Open storage compartment holds a wide variety of plates and trays.
- Use with or without detachable cutlery station.
- Made of easy-to-clean polyethylene that won't rust, peel or corrode.
- Rounded, molded-in corners protect furniture and walls.
- Molded-in handles and heavy-duty 6" (15,2 cm) swivel casters ease maneuvering.

Colors: Slate Blue (401), Coffee Beige (157), Dark Brown (131), Gray (180), Granite Gray (191), Granite Green (192).

6" Casters: All swivel, 2 with brake.

Vinyl cover is not NSF listed.



Flatware cylinders and vinyl cover included with TDCR12.

TDCR12

CODE	DESCRIPTION	CASE LBS. (CUBE)	LIST PRICE EA.
TDCR12	Cart & Rack Combination	88.9 (22.24)	\$ 1,215.00
TDC2029	Cart only	62 (18.14)	920.00
CR12	Cutlery Rack only	23.5 (4.46)	270.00
FWC56	Flatware Cylinder	2.73 (0.41)	4.00

Case Pack: 1, FWC56 Case Pack: 12

CODE	DESCRIPTION	L x W x H
TDCR12	Cart & Rack Combination	38 3/8" x 22 3/4" x 41 1/4"
TDC2029	Cart	38 3/8" x 22 3/4" x 34 1/4"
CR12	Cutlery Rack	33" x 22 3/4" x 9"

Tray & Silver Cart

- Use to neatly organize trays and accessories for self-service.
- Includes eight clear Camwear® food pans to hold flatware, napkins and non-perishable condiments.
- Protective vinyl cover included.

Colors: Slate Blue (401), Coffee Beige (157), Dark Brown (131), Gray (180), Granite Gray (191), Granite Green (192).

6" Casters: All swivel, 2 with brake.

Vinyl cover is not NSF listed.



TC1418

CODE	DESCRIPTION	CASE LBS. (CUBE)	LIST PRICE EA.
TC1418	Cart w/Pans & Vinyl Cover	84 (19.46)	\$ 1,000.00

Case Pack: 1

CODE	EXTERIOR DIMENSIONS L x W x H	WEIGHT CAPACITY	MAXIMUM TRAY SIZE	TRAY CAPACITY
TC1418	32 3/8" x 21 1/4" x 45 1/2"	500 lbs.	14" x 18"	180-200 in two stacks

CAMWEAR® PANS FOR SELF-SERVE TOP:

PAN QUANTITY, SIZE	CAPACITY
4 each, 1/2 size x 4" deep	Holds 100 knives, 100 spoons, 80 forks
4 each, 1/4 size x 4" deep	Holds variety of condiments



Vinyl cover included for sanitary storage.



S-SERIES ADJUSTABLE DISH CADDY

- Store one size dish or a combination of different sizes in a single caddy.
- Features easy-to-adjust column towers.

ADCS Colors: Black (110), Slate Blue (401), Speckled Gray (480), Dark Brown (131).

Casters: 5", 2 swivel with brakes and two 10" Wheels.

Vinyl cover included. Not NSF listed.

For square and rectangular plates, please contact Cambro for suggested use.



Holds plates and bowls from 4⁵/₈" to 13"

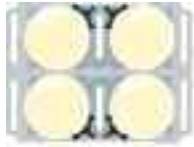

Plate sizes: 9³/₄" to 13" diam.
4 Columns (60 each)
Total Capacity: 240



Plate sizes: 7³/₄" to 9" diam.
6 Columns (60 each)
Total Capacity: 360

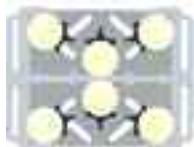

Plate sizes: 5³/₄" to 7" diam.
6 Columns (45 each)
Total Capacity: 270



2 Columns: 9³/₄" to 13" diam. (60 each)
5 Columns: 4³/₄" (45 each)
Total Capacity: 345



3 Columns: 7³/₄" to 9" diam. (60 each)
5 Columns: 4³/₄" (45 each)
Total Capacity: 405



2 Columns: 7³/₄" to 9" diam. (60 each)
2 Columns: 5³/₄" to 7" (45 each)
4 Columns: 4³/₄" (45 each)
Total Capacity: 390

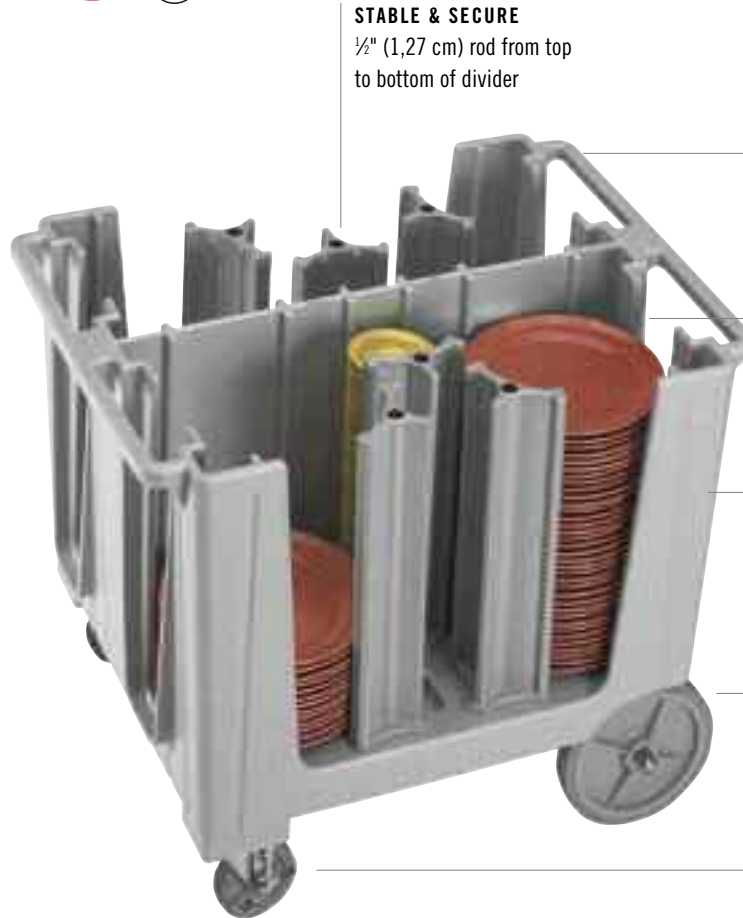

STABLE & SECURE

1/2" (1,27 cm) rod from top to bottom of divider

ADCS OVERALL DIMENSIONS

W 28⁵/₈" x L 37⁷/₈" x H 31⁷/₈"
(73 x 96 x 81 cm)

EASY TO MANEUVER

Ergonomic molded-in handles on both ends

HOLDING CAPACITY

Six 19¹/₂" (49,5 cm) storage columns hold 45-60 plates per stack

EXTREMELY DURABLE

Heavy duty polyethylene construction protects china from chipping. Won't chip, crack or rust

REAR WHEELS

10" (25,4 cm) non-marking Easy Wheels

FRONT CASTERS

5" (12,7 cm) swivel with brake



3/4" (2 cm) plated steel rear axle allows for 500 lb. (227 kg) load capacity



Vinyl cover included with every dolly for sanitary storage

CODE	ADCS
NUMBER OF DIVIDERS	6
PLATES PER COLUMN	Approximately 45-60
OVERALL DIMENSIONS W x L x H	28 ⁵ / ₈ " x 37 ⁷ / ₈ " x 31 ⁷ / ₈ "
CASE LBS. (CUBE)	133.8 (22.01)
LIST PRICE EACH	\$ 1,155.00

Case Pack: 1 Plate & Bowl size range from 4⁵/₈" to 13"
InStock Colors: Black (110), Speckled Gray (480).

DISH CADDIES, ADJUSTABLE TRAY & DISH CART

Dish Caddies

- Use to store and protect valuable dishware.
- Dividers are molded into the body in a standard poker chip design.
- Made of durable polyethylene that protects plates from chipping.
- Open access from two sides for easy loading and unloading.
- Rounded corners inside and out protect dishware, furniture and walls.

Colors: Black (110), Slate Blue (401), Dark Brown (131), Granite Gray (191).

Casters: 2, 5" swivel with brakes and two 10" Easy Wheels.

Vinyl cover included. Not NSF listed.



Sanitary plastic cover included and recommended for protecting clean dinnerware & trays. Replacement covers are available through the Cambro Replacement Parts List at www.cambro.com.

170

Dish Caddies

CODE	DC575	DC700	DC825
PLATE SIZE RANGE	up to 5 ³ / ₄ " (14,6 cm)	5 ⁷ / ₈ " - 7" (14,9 - 17,8 cm)	7 ⁷ / ₈ " - 8 ¹ / ₄ " (18,1 - 21 cm)
COLUMNS PER CADDY	6, 45-60 plates per col.	6, 45-60 plates per col.	4, 45-60 plates per col.
OVERALL DIMENSIONS W x L x H	32 ⁷ / ₈ " x 23 ¹ / ₂ " x 31 ³ / ₄ "	32 ⁷ / ₈ " x 23 ¹ / ₂ " x 31 ³ / ₄ "	28 ³ / ₄ " x 23 ³ / ₄ " x 32"
CASE LBS. (CUBE)	64 (14.59)	64 (14.59)	58 (12.82)
LIST PRICE EACH	\$ 925.00	\$ 925.00	\$ 925.00

Case Pack: 1



CODE	DC950	DC1125	DC1225
PLATE SIZE RANGE	8 ³ / ₈ " - 9 ¹ / ₂ " (21,3 - 24,1 cm)	9 ⁵ / ₈ " - 11 ¹ / ₄ " (24,4 - 28,6 cm)	11 ³ / ₈ " - 12 ¹ / ₄ " (28,9 - 31,1 cm)
COLUMNS PER CADDY	4, 45-60 plates per col.	4, 45-60 plates per col.	4, 45-60 plates per col.
OVERALL DIMENSIONS W x L x H	28 ⁷ / ₈ " x 23 ³ / ₄ " x 32"	32 ¹ / ₄ " x 27 ¹ / ₂ " x 32"	32 ³ / ₄ " x 27 ¹ / ₂ " x 32"
CASE LBS. (CUBE)	56 (14.03)	70 (17.54)	71 (17.78)
LIST PRICE EACH	\$ 935.00	\$ 975.00	\$ 990.00

Case Pack: 1



Adjustable Tray & Dish Cart

- Use to store a wide variety of plates and trays.
- Move two adjustable dividers into position easily to secure trays and plates.
- Made of durable polyethylene that cushions plates and trays to prevent chipping.
- Easy to clean and won't dent, rust, chip or break.

Colors: Black (110), Slate Blue (401), Coffee Beige (157), Dark Brown (131), Gray (180), Granite Gray (191), Granite Green (192).

Casters: 6", all swivel, 2 with brake.

Maximum load capacity: 500 lbs.

Vinyl cover included. Not NSF listed.



Sanitary plastic cover included.

Adjustable Tray & Dish Cart

CODE	TDC30
NUMBER OF DIVIDERS	2
PLATES PER COLUMN	Approximately 45-60
TRAYS PER COLUMN	80 Trays: 14" x 18"
OVERALL DIMENSIONS	W 23 ³ / ₄ " x L 38 ³ / ₈ " x H 34 ¹ / ₂ "
CASE LBS. (CUBE)	76.67 (18.74)
LIST PRICE EACH	\$ 1,210.00

Case Pack: 1



CAMRACK® SYSTEM: WASH, TRANSPORT AND STORE. ALL-IN-ONE.

WASH



TRANSPORT



STORE



172



OPEN INSIDE COMPARTMENTS provide thorough circulation of water and cleaning solutions and promote quick and thorough drying.

EXTREMELY DURABLE, long-lasting polypropylene Camracks are built to withstand chemicals and high temperatures up to 200°F (93°C).

EASY TO HANDLE, with ½" (1,3 cm) overlap and smooth sides. Interstacks with all racks from major dishrack manufacturers.

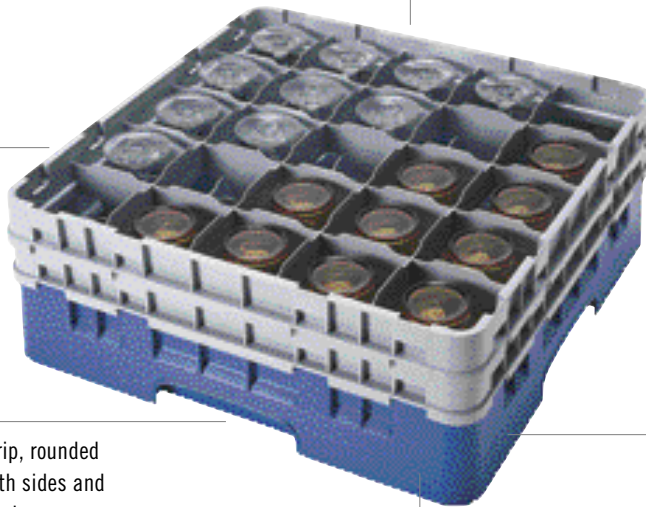

CONTENT LABELING options include one-color custom hot stamping or pre-printed clips that are added at factory during assembly.

EASY TO HANDLE, easy-to-grip, rounded handles on all four sides, smooth sides and rounded corners reduce risk of injury.

CLOSED EXTERNAL WALLS are designed for optimum cleaning and storage, keeping fingers and contaminants out and reducing risk of breakage and injury.

Enclosed, Portable Sanitary Storage System

- Simple to create by stacking filled Camracks on Camdollies® and covering top racks with Camrack Covers.
- Eliminate poorly-fitting plastic and vinyl covers that expose contents or drape onto dirty floors. No need for plastic wrap.



Color Coded Inventory Control

- Bright colors identify at a glance both contents and quantity per rack.
- 10 base colors and 2 extender colors provide 20 color-coding options.
- Gray extenders are standard unless beige extenders are specified.



Camracks are covered by one or more of the following patents: Full Base Dish Rack D412,607. Half Base Dish Rack D404,176. Half Dish Rack Extender D400,321. Enlarged Dish Rack Extender D399,614. Dish Rack with Extender 5,934,486 Utility Patent. Pronged Base Dish Rack D403,472

FULL SIZE CAMRACKS® FOR STEMWARE & TUMBLERS

These racks offer complete protection for all your delicate and valuable stemware and tumblers from washing and handling to stacking, storing and transporting.

Choose the correct dishrack:

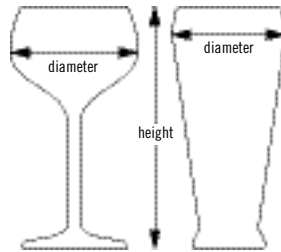

1. Measure the maximum diameter of your glass (stemware or tumbler) to determine the number of compartments.
2. Measure the maximum height of your glass (stemware or tumbler) to the top edge of the rim to determine the compartment height.







25S534

9 COMPARTMENT

Camrack Sizing Guides are available at www.cambro.com under Resource Center.

 5⁷/₈" 14,8 cm MAXIMUM DIAMETER	MAXIMUM HEIGHT		3⁵/₈" 9 cm	5¹/₄" 13,2 cm	6⁷/₈" 17,4 cm	8¹/₂" 21,6 cm	10¹/₈" 25,8 cm	11³/₄" 30 cm
		CODE		9S318	9S434	9S638	9S800	9S958
	CASE PACK		5	4	3	2	2	2
	CASE LBS. (CUBE)		23.5 (6.71)	28.68 (6.62)	23.5 (6.29)	19 (5.05)	22 (5.82)	28.6 (6.77)
	CASE KG (CUBE M ³)		10,67 (0,19)	11,35 (0,19)	10,67 (0,178)	8,63 (0,143)	9,99 (0,164)	11,35 (0,191)
	LIST PRICE EACH		\$ 45.55	\$ 59.40	\$ 70.90	\$ 86.20	\$ 99.95	\$ 116.40
	RACK DIMENSION		19 ³ / ₄ " x 19 ³ / ₄ " x 5 ⁵ / ₈ " 50 x 50 x 14,3 cm	19 ³ / ₄ " x 19 ³ / ₄ " x 7 ¹ / ₄ " 50 x 50 x 18,4 cm	19 ³ / ₄ " x 19 ³ / ₄ " x 8 ⁵ / ₈ " 50 x 50 x 22,5 cm	19 ³ / ₄ " x 19 ³ / ₄ " x 10 ¹ / ₂ " 50 x 50 x 26,7 cm	19 ³ / ₄ " x 19 ³ / ₄ " x 12 ¹ / ₂ " 50 x 50 x 30,8 cm	19 ³ / ₄ " x 19 ³ / ₄ " x 13 ³ / ₄ " 50 x 50 x 34,9 cm

16 COMPARTMENT

 4³/₈" 10,9 cm MAXIMUM DIAMETER	MAXIMUM HEIGHT		3⁵/₈" 9 cm	4¹/₂" 11 cm	5¹/₄" 13,2 cm	6¹/₈" 15,2 cm	6⁷/₈" 17,4 cm	7³/₄" 19,4 cm
		CODE		16S318	16S418**	16S434	16S534**	16S638
	CASE PACK		5	5	4	4	3	3
	CASE LBS. (CUBE)		28 (6.77)	29.5 (6.77)	29 (6.77)	30.5 (6.77)	27 (6.29)	28.5 (6.29)
	CASE KG (CUBE M ³)		12,7 (0,191)	13,4 (0,191)	13,15 (0,191)	13,83 (0,191)	12,25 (0,178)	12,92 (0,178)
	LIST PRICE EACH		\$ 45.55	\$ 47.70	\$ 59.70	\$ 61.10	\$ 71.65	\$ 73.15
	RACK DIMENSION		19 ³ / ₄ " x 19 ³ / ₄ " x 5 ⁵ / ₈ " 50 x 50 x 14,3 cm	19 ³ / ₄ " x 19 ³ / ₄ " x 5 ⁵ / ₈ " 50 x 50 x 14,3 cm	19 ³ / ₄ " x 19 ³ / ₄ " x 7 ¹ / ₄ " 50 x 50 x 18,4 cm	19 ³ / ₄ " x 19 ³ / ₄ " x 7 ¹ / ₄ " 50 x 50 x 18,4 cm	19 ³ / ₄ " x 19 ³ / ₄ " x 8 ⁵ / ₈ " 50 x 50 x 22,5 cm	19 ³ / ₄ " x 19 ³ / ₄ " x 8 ⁵ / ₈ " 50 x 50 x 22,5 cm
	MAXIMUM HEIGHT		8¹/₂" 21,6 cm	9³/₈" 23,8 cm	10¹/₈" 25,8 cm	11" 27,8 cm	11³/₄" 30 cm	12⁵/₈" 32 cm
	CODE		16S800	16S900**	16S958	16S1058**	16S1114	16S1214**
	CASE PACK		2	2	2	2	2	2
	CASE LBS. (CUBE)		22.48 (4.97)	22.48 (4.97)	25.17 (5.57)	25.82 (5.82)	29 (6.77)	29.5 (6.77)
	CASE KG (CUBE M ³)		9,97 (0,143)	10,55 (0,143)	11,34 (0,164)	11,9 (0,164)	13,15 (0,191)	13,38 (0,191)
LIST PRICE EACH		\$ 86.50	\$ 88.05	\$ 99.95	\$ 101.50	\$ 116.40	\$ 117.80	
RACK DIMENSION		19 ³ / ₄ " x 19 ³ / ₄ " x 10 ¹ / ₂ " 50 x 50 x 26,7 cm	19 ³ / ₄ " x 19 ³ / ₄ " x 10 ¹ / ₂ " 50 x 50 x 26,7 cm	19 ³ / ₄ " x 19 ³ / ₄ " x 12 ¹ / ₂ " 50 x 50 x 30,8 cm	19 ³ / ₄ " x 19 ³ / ₄ " x 12 ¹ / ₂ " 50 x 50 x 30,8 cm	19 ³ / ₄ " x 19 ³ / ₄ " x 13 ³ / ₄ " 50 x 50 x 34,9 cm	19 ³ / ₄ " x 19 ³ / ₄ " x 13 ³ / ₄ " 50 x 50 x 34,9 cm	

Base Rack Colors:

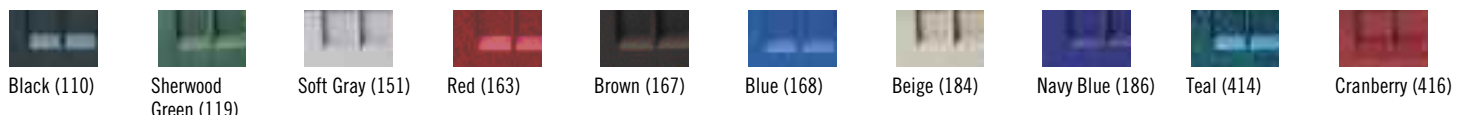





InStock Color: Soft Gray (151).

**Compartment Extenders cannot be added. Personalization available.

FULL SIZE CAMRACKS® FOR STEMWARE & TUMBLERS

25 COMPARTMENT





Camrack Sizing Guides are available at www.cambro.com under Resource Center.

 <p>3 1/2" 8,7 cm MAXIMUM DIAMETER</p> 	MAXIMUM HEIGHT 	3 5/8" 9 cm	4 1/2" 11 cm	5 1/4" 13,2 cm	6 1/8" 15,2 cm	6 7/8" 17,4 cm	7 3/4" 19,4 cm
	CODE	25S318	25S418**	25S434	25S534**	25S638	25S738**
	CASE PACK	5	5	4	4	3	3
	CASE LBS. (CUBE)	24.65 (6.64)	30 (6.77)	27.1 (6.66)	28.9 (6.67)	25.99 (6.17)	27.34 (6.17)
	CASE KG (CUBE M³)	12,7 (0,191)	13,6 (0,191)	13,6 (0,191)	14,51 (0,191)	12,7 (0,178)	13,6 (0,178)
	LIST PRICE EACH	\$ 45.55	\$ 49.25	\$ 60.45	\$ 63.40	\$ 72.35	\$ 78.25
	RACK DIMENSION	19 3/4" x 19 3/4" x 5 5/8" 50 x 50 x 14,3 cm	19 3/4" x 19 3/4" x 5 5/8" 50 x 50 x 14,3 cm	19 3/4" x 19 3/4" x 7 1/4" 50 x 50 x 18,4 cm	19 3/4" x 19 3/4" x 7 1/4" 50 x 50 x 18,4 cm	19 3/4" x 19 3/4" x 8 7/8" 50 x 50 x 22,5 cm	19 3/4" x 19 3/4" x 8 7/8" 50 x 50 x 22,5 cm
	MAXIMUM HEIGHT 	8 1/2" 21,6 cm	9 3/8" 23,8 cm	10 1/8" 25,8 cm	11" 27,8 cm	11 3/4" 30 cm	12 5/8" 32 cm
	CODE	25S800	25S900**	25S958	25S1058**	25S1114	25S1214**
	CASE PACK	2	2	2	2	2	2
	CASE LBS. (CUBE)	21.65 (4.91)	222.85 (4.85)	27.66 (5.82)	29.98 (5.82)	28.59 (6.77)	25.18 (6.77)
	CASE KG (CUBE M³)	10,43 (0,143)	10,87 (0,143)	12,25 (0,164)	12,7 (0,164)	13,6 (0,191)	14,06 (0,191)
	LIST PRICE EACH	\$ 86.50	\$ 94.00	\$ 99.95	\$ 108.90	\$ 116.40	\$ 125.30
	RACK DIMENSION	19 3/4" x 19 3/4" x 10 1/2" 50 x 50 x 26,7 cm	19 3/4" x 19 3/4" x 10 1/2" 50 x 50 x 26,7 cm	19 3/4" x 19 3/4" x 12 1/2" 50 x 50 x 30,8 cm	19 3/4" x 19 3/4" x 12 1/2" 50 x 50 x 30,8 cm	19 3/4" x 19 3/4" x 13 3/4" 50 x 50 x 34,9 cm	19 3/4" x 19 3/4" x 13 3/4" 50 x 50 x 34,9 cm

InStock Color: Soft Gray (151).



**Compartment Extenders cannot be added.

36 COMPARTMENT

 <p>2 7/8" 7,2 cm MAXIMUM DIAMETER</p> 	MAXIMUM HEIGHT 	3 5/8" 9 cm	4 1/2" 11 cm	5 1/4" 13,2 cm	6 1/8" 15,2 cm	6 7/8" 17,4 cm	7 3/4" 19,4 cm
	CODE	36S318	36S418**	36S434	36S534**	36S638	36S738**
	CASE PACK	5	5	4	4	3	3
	CASE LBS. (CUBE)	29 (6.77)	32 (6.77)	31.74 (6.62)	34 (6.77)	30 (6.29)	32 (6.29)
	CASE KG (CUBE M³)	13,15 (0,191)	14,51 (0,191)	14,51 (0,191)	15,42 (0,191)	13,6 (0,178)	14,51 (0,178)
	LIST PRICE EACH	\$ 47.70	\$ 51.45	\$ 61.10	\$ 66.35	\$ 73.75	\$ 82.00
	RACK DIMENSION	19 3/4" x 19 3/4" x 5 5/8" 50 x 50 x 14,3 cm	19 3/4" x 19 3/4" x 5 5/8" 50 x 50 x 14,3 cm	19 3/4" x 19 3/4" x 7 1/4" 50 x 50 x 18,4 cm	19 3/4" x 19 3/4" x 7 1/4" 50 x 50 x 18,4 cm	19 3/4" x 19 3/4" x 8 7/8" 50 x 50 x 22,5 cm	19 3/4" x 19 3/4" x 8 7/8" 50 x 50 x 22,5 cm
	MAXIMUM HEIGHT 	8 1/2" 21,6 cm	9 3/8" 23,8 cm	10 1/8" 25,8 cm	11" 27,8 cm	11 3/4" 30 cm	12 5/8" 32 cm
	CODE	36S800	36S900**	36S958	36S1058**	36S1114	36S1214**
	CASE PACK	2	2	2	2	2	2
	CASE LBS. (CUBE)	24 (5.05)	25.73 (4.98)	28.42 (5.82)	30 (5.82)	13.49 (6.77)	28.57 (6.77)
	CASE KG (CUBE M³)	10,87 (0,143)	11,34 (0,143)	12,7 (0,164)	13,6 (0,164)	14,51 (0,191)	14,97 (0,191)
	LIST PRICE EACH	\$ 88.05	\$ 97.75	\$ 102.95	\$ 112.65	\$ 116.40	\$ 127.60
	RACK DIMENSION	19 3/4" x 19 3/4" x 10 1/2" 50 x 50 x 26,7 cm	19 3/4" x 19 3/4" x 10 1/2" 50 x 50 x 26,7 cm	19 3/4" x 19 3/4" x 12 1/2" 50 x 50 x 30,8 cm	19 3/4" x 19 3/4" x 12 1/2" 50 x 50 x 30,8 cm	19 3/4" x 19 3/4" x 13 3/4" 50 x 50 x 34,9 cm	19 3/4" x 19 3/4" x 13 3/4" 50 x 50 x 34,9 cm

**Compartment Extenders cannot be added.

49 COMPARTMENT

 <p>2 7/16" 6 cm MAXIMUM DIAMETER</p> 	MAXIMUM HEIGHT 	3 5/8" 9 cm	5 1/4" 13,2 cm	6 7/8" 17,4 cm	8 1/2" 21,6 cm	10 1/8" 25,8 cm	11 3/4" 30 cm
	CODE	49S318	49S434	49S638	49S800	49S958	49S1114
	CASE PACK	5	4	3	2	2	2
	CASE LBS. (CUBE)	31.05 (6.59)	33.67 (6.71)	32.12 (6.13)	26.22 (4.94)	30.62 (5.59)	31 (6.77)
	CASE KG (CUBE M³)	11,92 (0,19)	13,17 (0,19)	12,71 (0,178)	10,44 (0,143)	12,26 (0,164)	14,07 (0,191)
	LIST PRICE EACH	\$ 48.45	\$ 62.60	\$ 75.40	\$ 88.05	\$ 104.45	\$ 120.85
RACK DIMENSION	19 3/4" x 19 3/4" x 5 5/8" 50 x 50 x 14,3 cm	19 3/4" x 19 3/4" x 7 1/4" 50 x 50 x 18,4 cm	19 3/4" x 19 3/4" x 8 7/8" 50 x 50 x 22,5 cm	19 3/4" x 19 3/4" x 10 1/2" 50 x 50 x 26,7 cm	19 3/4" x 19 3/4" x 12 1/2" 50 x 50 x 30,8 cm	19 3/4" x 19 3/4" x 13 3/4" 50 x 50 x 34,9 cm	

HALF SIZE CAMRACKS® FOR STEMWARE & TUMBLERS



- Very effective for carrying less weight and for storing drinkware in space-restricted locations.
- Ideal for small under-counter glasswashers.





10HS434

8 COMPARTMENT



Camrack Sizing Guides are available at www.cambro.com under Resource Center.

 4¹/₈" 10,3 cm MAXIMUM DIAMETER	MAXIMUM HEIGHT  3⁵/₈" 9 cm	5¹/₄" 13,2 cm	6⁷/₈" 17,4 cm	8¹/₂" 21,6 cm	10¹/₈" 25,8 cm	11³/₄" 30 cm	
		CODE	8HS318	8HS434	8HS638	8HS800	8HS958
CASE PACK		5	4	3	2	2	2
CASE LBS. (CUBE)		16.94 (3.3)	19 (3.55)	17.75 (3.18)	14.25 (2.62)	16.5 (2.93)	17.87 (3.44)
CASE KG (CUBE M³)		8,06 (0,0994)	8,63 (0,098)	8,06 (0,089)	6,47 (0,0734)	7,49 (0,082)	8,51 (0,0994)
LIST PRICE EACH		\$ 34.30	\$ 46.95	\$ 56.70	\$ 68.60	\$ 80.60	\$ 92.45
RACK DIMENSION		19 ³ / ₄ " x 10" x 5 ⁵ / ₈ " 50 x 25 x 14,3 cm	19 ³ / ₄ " x 10" x 7 ¹ / ₄ " 50 x 25 x 18,4 cm	19 ³ / ₄ " x 10" x 8 ⁵ / ₈ " 50 x 25 x 22,5 cm	19 ³ / ₄ " x 10" x 10 ¹ / ₂ " 50 x 25 x 26,7 cm	19 ³ / ₄ " x 10" x 12 ⁵ / ₈ " 50 x 25 x 30,8 cm	19 ³ / ₄ " x 10" x 13 ³ / ₄ " 50 x 25 x 34,9 cm

10 COMPARTMENT

 3¹/₂" 8,7 cm MAXIMUM DIAMETER	MAXIMUM HEIGHT  3⁵/₈" 9 cm	5¹/₄" 13,2 cm	6⁷/₈" 17,4 cm	8¹/₂" 21,6 cm	10¹/₈" 25,8 cm	11³/₄" 30 cm	
		CODE	10HS318	10HS434	10HS638	10HS800	10HS958
CASE PACK		5	4	3	2	2	2
CASE LBS. (CUBE)		18 (3.55)	19 (3.55)	18 (3.18)	14.5 (2.62)	16.75 (2.93)	18.48 (3.44)
CASE KG (CUBE M³)		8,17 (0,0994)	8,63 (0,0994)	8,17 (0,089)	6,58 (0,0734)	7,6 (0,082)	8,74 (0,0994)
LIST PRICE EACH		\$ 34.30	\$ 46.95	\$ 56.70	\$ 68.60	\$ 80.60	\$ 92.45
RACK DIMENSION		19 ³ / ₄ " x 10" x 5 ⁵ / ₈ " 50 x 25 x 14,3 cm	19 ³ / ₄ " x 10" x 7 ¹ / ₄ " 50 x 25 x 18,4 cm	19 ³ / ₄ " x 10" x 8 ⁵ / ₈ " 50 x 25 x 22,5 cm	19 ³ / ₄ " x 10" x 10 ¹ / ₂ " 50 x 25 x 26,7 cm	19 ³ / ₄ " x 10" x 12 ⁵ / ₈ " 50 x 25 x 30,8 cm	19 ³ / ₄ " x 10" x 13 ³ / ₄ " 50 x 25 x 34,9 cm

17 COMPARTMENT

 2¹⁵/₁₆" 7,3 cm MAXIMUM DIAMETER	MAXIMUM HEIGHT  3⁵/₈" 9 cm	5¹/₄" 13,2 cm	6⁷/₈" 17,4 cm	8¹/₂" 21,6 cm	10¹/₈" 25,8 cm	11³/₄" 30 cm	
		CODE	17HS318	17HS434	17HS638	17HS800	17HS958
CASE PACK		5	4	3	2	2	2
CASE LBS. (CUBE)		18.25 (3.55)	19.75 (3.55)	18.75 (3.18)	15.55 (2.76)	18.01 (2.95)	20.25 (3.55)
CASE KG (CUBE M³)		8,29 (0,0994)	8,97 (0,0994)	8,51 (0,089)	6,92 (0,0734)	7,95 (0,082)	9,19 (0,0994)
LIST PRICE EACH		\$ 35.80	\$ 48.90	\$ 61.65	\$ 74.65	\$ 87.50	\$ 99.95
RACK DIMENSION		19 ³ / ₄ " x 10" x 5 ⁵ / ₈ " 50 x 25 x 14,3 cm	19 ³ / ₄ " x 10" x 7 ¹ / ₄ " 50 x 25 x 18,4 cm	19 ³ / ₄ " x 10" x 8 ⁵ / ₈ " 50 x 25 x 22,5 cm	19 ³ / ₄ " x 10" x 10 ¹ / ₂ " 50 x 25 x 26,7 cm	19 ³ / ₄ " x 10" x 12 ⁵ / ₈ " 50 x 25 x 30,8 cm	19 ³ / ₄ " x 10" x 13 ³ / ₄ " 50 x 25 x 34,9 cm

Base Rack Colors:



Sherwood Green (119)



Soft Gray (151)



Brown (167)



Beige (184)



Navy Blue (186)



Cranberry (416)

Standard Extender Color: Soft Gray (151). **Optional Extender Color:** Beige (184). Personalization available. See Camrack personalization and color coding page. Contact Customer Service for all special orders.

CAMRACK® FULL & HALF SIZE CUP RACKS

Camrack® Cup Racks

Tilt feature drains water from mug or cup bases for quick and sanitary drying.



16C414

16 COMPARTMENT

4³/₈" X 4³/₈" 11,1 x 11,1 cm COMPARTMENT DIMENSIONS	MAX. HEIGHT	2⁵/₈" 6,6 cm	4¹/₄" 10,7 cm	5⁷/₈" 14,9 cm
	CODE	16C258	16C414	16C578
	CASE PACK	6	5	4
	CASE LBS. (CUBE)	28.79(5.35)	32.85 (6.64)	33 (6.77)
	CASE KG (CUBE M ³)	9,53 (0,1582)	10,78 (0,194)	11,78 (0,192)
	LIST PRICE EACH	\$ 32.40	\$ 45.15	\$ 67.45
	RACK DIMENSION	19 ³ / ₄ " x 19 ³ / ₄ " x 4" 50 x 50 x 10,1 cm	19 ³ / ₄ " x 19 ³ / ₄ " x 5 ¹ / ₂ " 50 x 50 x 14,3 cm	19 ³ / ₄ " x 19 ³ / ₄ " x 7 ¹ / ₄ " 50 x 50 x 18,4 cm

InStock Color: Soft Gray (151).

20 COMPARTMENT

4³/₈" X 3¹/₂" 11,1 x 8 cm COMPARTMENT DIMENSIONS	MAX. HEIGHT	2⁵/₈" 6,6 cm	4¹/₄" 10,7 cm
	CODE	20C258	20C414
	CASE PACK	6	5
	CASE LBS. (CUBE)	29.13 (5.45)	33.01 (6.62)
	CASE KG (CUBE M ³)	9,65 (0,1582)	10,9 (0,194)
	LIST PRICE EACH	\$ 33.60	\$ 46.20
	RACK DIMENSION	19 ³ / ₄ " x 19 ³ / ₄ " x 4" 50 x 50 x 10,1 cm	19 ³ / ₄ " x 19 ³ / ₄ " x 5 ¹ / ₂ " 50 x 50 x 14,3 cm

InStock Color: Soft Gray (151).

8 COMPARTMENT

4¹/₈" X 4⁷/₁₆" 10,4 x 11,2 cm COMPARTMENT DIMENSIONS	MAX. HEIGHT	2⁵/₈" 6,6 cm	4¹/₄" 10,7 cm
	CODE	8HC258	8HC414
	CASE PACK	6	5
	CASE LBS. (CUBE)	16 (2.77)	18.91 (3.18)
	CASE KG (CUBE M ³)	7,26 (0,0776)	7,72 (0,0994)
	LIST PRICE EACH	\$ 23.10	\$ 38.35
	RACK DIMENSION	19 ³ / ₄ " x 9 ¹ / ₂ " x 4" 50 x 25 x 10,1 cm	19 ³ / ₄ " x 9 ¹ / ₂ " x 5 ¹ / ₂ " 50 x 25 x 14,3 cm

10 COMPARTMENT

4¹/₈" X 3¹/₂" 10,4 x 8,8 cm COMPARTMENT DIMENSIONS	MAX. HEIGHT	2⁵/₈" 6,6 cm	4¹/₄" 10,7 cm
	CODE	10HC258	10HC414
	CASE PACK	6	5
	CASE LBS. (CUBE)	16.25 (2.77)	17.25 (3.55)
	CASE KG (CUBE M ³)	7,38 (0,0776)	7,83 (0,0994)
	LIST PRICE EACH	\$ 23.10	\$ 38.35
	RACK DIMENSION	19 ³ / ₄ " x 9 ¹ / ₂ " x 4" 50 x 25 x 10,1 cm	19 ³ / ₄ " x 9 ¹ / ₂ " x 5 ¹ / ₂ " 50 x 25 x 14,3 cm

Base Cup Rack Color: Soft Gray (151). Standard Extender Color: Soft Gray (151). Optional Extender Color: Beige (184). Personalization available. See Camrack personalization and color coding page. Contact Customer Service for all special orders.

Glass and Cup Keepers

- Raised ribs for easy draining and drying
- Holds 20 glasses per layer.

Color: Beige (133).



Max. Glass Inside Rim Diameter:
GK2000: 2⁵/₈" (6,6 cm)



Max. Cup Inside Rim Diameter:
KK1200: 2¹⁵/₁₆" (7,4 cm)

CODE	SIZE	CASE LBS. (CUBE)	LIST PRICE EA.
Glass Keepers			
GK2000	14" x 18"	16 (0.94)	16.45
Cup Keepers			
KK1200	13 ¹⁵ / ₁₆ " x 17 ⁷ / ₈ "	14 ¹ / ₄ (0.78)	15.50

Case Pack: 12

CAMRACK® BASE RACKS

- For pots, pans, bowls and large prep, service and display items.
- Half racks work well for storing items at a wait station.



BR578

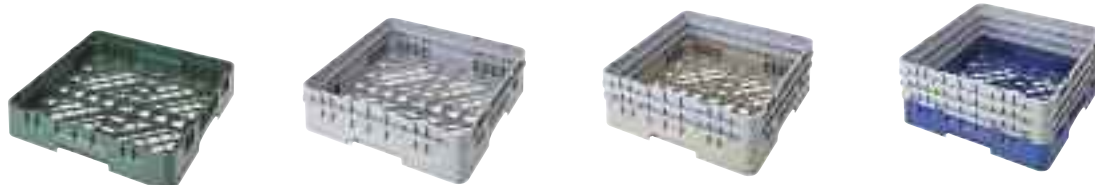

FULL SIZE BASE RACKS

	FULL BASE RACK	WITH 1 EXTENDER	WITH 2 EXTENDERS	WITH 3 EXTENDERS
CODE	BR258	BR414	BR578	BR712
INSIDE RACK HEIGHT	3¼" (8,3 cm)	4⅞" (12,4 cm)	6½" (16,5 cm)	8⅞" (20,6 cm)
OUTSIDE RACK HEIGHT	4" (10,1 cm)	5⅝" (14,3 cm)	7¼" (18,4 cm)	8⅞" (22,5 cm)
CASE PACK	6	5	4	3
CASE LBS. (CUBE)	18.67 (4.69)	18.67 (6.666)	22.5 (6.93)	20.5 (6.44)
CASE KG (CUBE M³)	8,85 (0,1582)	9,99 (0,194)	10,22 (0,194)	9,31 (0,1803)
LIST PRICE EACH	\$ 29.75	\$ 43.30	\$ 55.55	\$ 68.15
RACK DIMENSION	19¾" x 19¾" x 4" 50 x 50 x 10.1 cm	19¾" x 19¾" x 5⅝" 50 x 50 x 14.3 cm	19¾" x 19¾" x 7¼" 50 x 50 x 18.4 cm	19¾" x 19¾" x 8⅞" 50 x 50 x 22.5 cm

InStock Color: Soft Gray (151).



HALF SIZE BASE RACKS

	HALF BASE RACK	WITH 1 EXTENDER	WITH 2 EXTENDERS	WITH 3 EXTENDERS
CODE	HBR258	HBR414	HBR578	HBR712
INSIDE RACK HEIGHT	3¼" (8,3 cm)	4⅞" (12,4 cm)	6½" (16,5 cm)	8⅞" (20,6 cm)
OUTSIDE RACK HEIGHT	4" (10,1 cm)	5⅝" (14,3 cm)	7¼" (18,4 cm)	8⅞" (22,5 cm)
CASE PACK	6	5	4	3
CASE LBS. (CUBE)	13.50 (2.70)	15.99 (3.3)	16.56 (3.44)	15.86 (3.18)
CASE KG (CUBE M³)	6,47 (0,0776)	7,04 (0,0994)	6,92 (0,0994)	6,36 (0,089)
LIST PRICE EACH	\$ 20.15	\$ 32.45	\$ 41.80	\$ 51.45
RACK DIMENSION	19¾" x 9⅞" x 4" 50 x 25 x 10.1 cm	19¾" x 9⅞" x 5⅝" 50 x 25 x 14.3 cm	19¾" x 9⅞" x 7¼" 50 x 25 x 18.4 cm	19¾" x 9⅞" x 8⅞" 50 x 25 x 22.5 cm

Hold Down Grid

Keeps lightweight smallwares in place during wash cycle. Use on full size Camrack base rack.



	HOLD DOWN GRID
CODE	CRPHDG2878
GRID SIZE	FULL
CASE LBS. (CUBE)	10.15 (0.46)
CASE KG (CUBE M³)	4,60 (0,013)
LIST PRICE EACH	\$ 25.85

Case Pack: 1 Color: Gray (000)

Base Rack Colors:

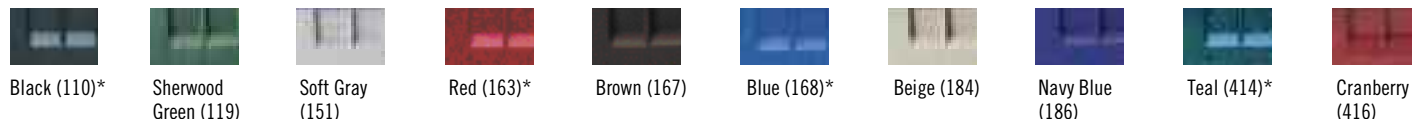

*Full size only. **Standard Extender Color:** Soft Gray (151). **Optional Extender Color:** Beige (184). Personalization available. See Camrack personalization and color coding page. Contact Customer Service for all special orders.

CAMRACK® FULL SIZE PEG RACKS & TRAY RACK

Standard 9 x 9 Peg Rack

- Designed to wash varying sized plates, bowls, trays and plate covers.
- Standard peg racks hold:
 - Eighteen 10" (25,4 cm) plates
 - Twelve 12" (30,5 cm) plates
 - Twenty seven 7½" (19 cm) plates
 - or
 - Nine 14" x 18" (36 x 46 cm) trays

5 x 9 Peg Rack

- Holds standard plates in one direction or deep plates, bowls and plate covers in the other direction.
- 5 spacing configuration holds up to ten 10" bowls, deep plates, platters or plate covers.

- 9 spacing configuration holds up to:
 - Eighteen 10" (25,4 cm) plates
 - Twelve 12" (30,5 cm) plates
 - Twenty seven 7½" (19 cm) plates
 - or
 - Nine 14" x 18" (36 x 46 cm) trays

Open End Tray Rack

- Holds cafeteria trays or full-size sheet pans.
- Open-ended on one side for easy placement and removal of trays of all lengths.
- Holds up to nine trays upright.



	9 X 9 PEG RACK	9 X 9 PEG RACK WITH 1 EXTENDER	5 X 9 PEG RACK	5 X 9 PEG RACK WITH 1 EXTENDER	OPEN END TRAY RACK
CODE	PR314	PR500	PR59314	PR59500	OETR314*
INSIDE RACK HEIGHT	3¼" (8,3 cm)	4⅞" (12,4 cm)	3¼" (8,3 cm)	4⅞" (12,4 cm)	3¼" (8,3 cm)
OUTSIDE RACK HEIGHT	4" (10,1 cm)	5⅝" (14,3 cm)	4" (10,1 cm)	5⅝" (14,3 cm)	4" (10,1 cm)
CASE PACK	6	5	6	5	6
CASE LBS. (CUBE)	27.09 (5.42)	17 (6.93)	24.73 (5.64)	26.9 (6.61)	26.67 (5.51)
CASE KG (CUBE M³)	9,99 (0,1582)	8,29 (0,194)	9,99 (0,1582)	8,29 (0,194)	8,4 (0,1582)
LIST PRICE EACH	\$ 32.05	\$ 45.55	\$ 32.05	\$ 45.55	\$ 31.35

Color: Soft Gray (151). Standard Extender Color: Soft Gray (151). Optional Extender Color: Beige (184). InStock Color: Soft Gray (151). Personalization available.

* Extenders may be added to all Peg Racks except the OETR314.

CAMRACK® FULL & HALF SIZE FLATWARE RACKS & CYLINDERS

Camrack® Flatware Racks

- 8 Compartment Basket fits into a Full or Half Size Base Rack. Wire handles slide down for easy storage.

- Flatware Cylinder fits into 8-compartment Half Size Camrack and the Cambro Tray and Dish Cart, model TDCR12.

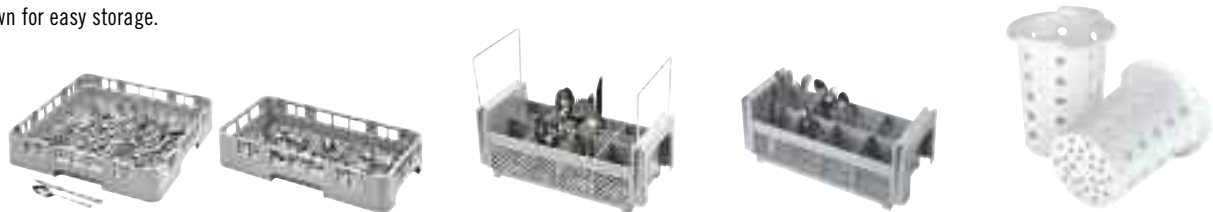

	FULL FLATWARE RACK	HALF FLATWARE RACK	8 COMPARTMENT HALF FLATWARE BASKET	8 COMPARTMENT HALF FLATWARE BASKET	FLATWARE CYLINDER
CODE	FR258	HFR258	8FB434* With Handles	8FBNH434* No Handles	FWC56
INSIDE RACK HEIGHT	2⅝" (6,7 cm)	2⅝" (6,7 cm)	4¾" (12 cm)	4¾" (12 cm)	4½" wide (11,43 cm)
OUTSIDE RACK HEIGHT	4" (10,1 cm)	4" (10,1 cm)	7¼" (18,4 cm)	7¼" (18,4 cm)	5½" high (13,97)
CASE PACK	6	6	6	6	12
CASE LBS. (CUBE)	24.59 (5.45)	15.26 (2.76)	19 (3.73)	17.46 (3.69)	2.76 (0.41)
CASE KG (CUBE M³)	9,08 (0,1582)	7,15 (0,0776)	8,17 (0,105)	8,16 (0,105)	1,24 (0,012)
LIST PRICE EACH	\$32.05	\$27.60	\$38.05	\$22.40	\$4.00

Color: Soft Gray (151). Standard Extender Color: Soft Gray (151). Optional Extender Color: Beige (184). InStock Color: Soft Gray (151).

Personalization available (excludes flatware baskets). Contact Customer Service for all special orders. * Extenders cannot be added. Flatware Cylinder Color: White (148).

CAMRACK® PLATESAFE™

- Effectively wash, store and transport dinnerware.
- Vinyl coated steel grids safely hold and separate plates within each rack.
- Add a Camdolly® and Cover to create a completely-enclosed, sanitary storage unit between uses.
- Reduces breakage.
- Holds plates upright and securely in place.
- No need to transfer to dish caddies, reducing labor.



CRPH1656
Half Size PlateSafe Camrack



Transport racks to banquet area for quick set up.



PlateSafe Camracks



Optional Beige Extenders

Quickly identify Camrack contents. Use beige extenders on PlateSafe Camracks and gray extenders on Camrack drinkware racks.



Portable Sanitary Storage System

Completely enclose and protect Camracks by stacking racks on a Camdolly and covering with a Camrack cover.

PLATE SIZE	4-5" 10,1–12,7 cm	4-6" 10,1–15,2 cm	5-6" 12,7–15,2 cm	6-7" 15,2–17,7 cm	6-7 ⁵ / ₈ " 15,2–19,3 cm	7-8 ⁵ / ₈ " 17,7–21,9 cm	9-10 ¹ / ₄ " 22,8–26 cm	9-10 ¹ / ₂ " 22,8–26,6 cm
MAX. PLATE HEIGHT	¾" (1,9 cm)	2" (5 cm)	¾" (1,9 cm)	¾" (1,91 cm)	1" (2,5 cm)	1" (2,5 cm)	1" (2,54 cm)	1¼" (4,4 cm)
# OF PLATES	63	20	48	44	30	28	20	12
CODE	CRP6345	CRP2046	CRP4856	CRP4467	CRP3067	CRP2878	CRP20910	CRP12910
RACK SIZE	FULL	FULL	FULL	FULL	FULL	FULL	FULL	FULL
EXT. RACK HEIGHT	7¼" (18,4 cm)	7¼" (18,4 cm)	7¼" (18,4 cm)	8 ⁷ / ₈ " (22,5 cm)	8 ⁷ / ₈ " (22,5 cm)	10½" (26,7 cm)	12 ⁷ / ₈ " (30,8 cm)	12 ⁷ / ₈ " (30,8 cm)
CASE PACK	2	2	2	2	2	1	1	1
CASE LBS (CUBE)	22.45 (3.43)	17.44 (3.48)	20.54 (3.43)	31.42 (4.27)	19.5 (4.03)	12.94 (2.59)	14.08 (2.97)	11.1 (2.83)
CASE KG (CUBE M³)	8,71 (0,092)	7,17 (0,092)	8,35 (0,092)	9,39 (0,114)	8,85 (0,114)	4,9 (0,07)	5,31 (0,08)	5,03 (0,08)
LIST PRICE EA.	\$ 127.90	\$ 127.90	\$ 127.90	\$ 138.00	\$ 127.90	\$ 127.90	\$ 148.10	\$ 130.75

PLATE SIZE	9-11 ¹ / ₈ " 22,8–28,2 cm	9-11" 22,8–27,9 cm	10-11" 25,4–27,9 cm	10 ¹ / ₂ -12 ¹ / ₂ " 26,6–31,7 cm	11 ¹ / ₂ -12 ¹ / ₂ " 29,2–31,7 cm	5-6 ⁷ / ₈ " 12,7–17,5 cm
MAX. PLATE HEIGHT	1¼" (4,4 cm)	2¼" (5,7 cm)	1" (2,5 cm)	1½" (3,4 cm)	1" (2,5 cm)	1" (2,5 cm)
# OF PLATES	12	9	19	14	18	16
CODE	CRP12911	CRP9911	CRP191011	CRP141012	CRP181112	CRPH1656
RACK SIZE	FULL	FULL	FULL	FULL	FULL	HALF
EXT. RACK HEIGHT	12 ⁷ / ₈ " (30,8 cm)	12 ⁷ / ₈ " (30,8 cm)	12 ⁷ / ₈ " (30,8 cm)	13¾" (34,9 cm)	13¾" (34,9 cm)	7¼" (18,4 cm)
CASE PACK	1	1	1	1	1	4
CASE LBS (CUBE)	15.07 (3.08)	11.95 (2.83)	15.42 (3.00)	13.85 (3.26)	14.45 (3.26)	23.52 (3.53)
CASE KG (CUBE M³)	5,49 (0,08)	5,42 (0,08)	5,96 (0,08)	6,28 (0,092)	6,55 (0,092)	10,67 (0,1)
LIST PRICE EA.	\$ 167.05	\$ 167.05	\$ 167.05	\$ 181.55	\$ 188.85	\$ 101.70

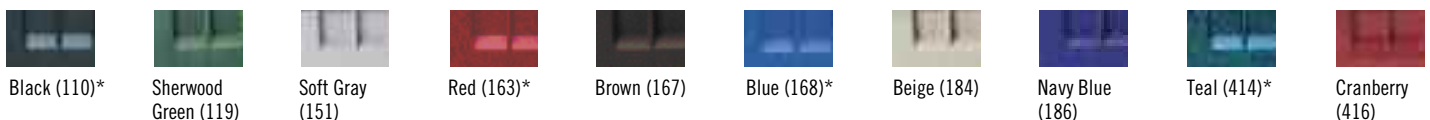

*Full size only. Standard Extender Color: Soft Gray (151). Optional Extender Color: Beige (184). Personalization available. See Camrack personalization and color coding page.

STORE AND TRANSPORT GLASSES AND DISHES

Camrack® Cover

- Use to cover and protect full size Camrack® dishracks filled with clean dishware.
- When used with a Camdolly®, creates a portable sanitary storage system that protects contents between uses.

- Eliminates the use of messy, time-consuming plastic wrap or vinyl covers.



FULL RACK COVER	
CODE	DRC2020
EXTERIOR DIMENSIONS	19 ⁵ / ₈ " x 19 ⁵ / ₈ " x 1 ⁵ / ₁₆ " (50 x 50 x 2,4 cm)
CASE LBS. (CUBE)	4.2 (0.34)
CASE KG (CUBE M ³)	0,91 (0,0098)
LIST PRICE EACH	\$ 50.50

Case Pack: 1

InStock Color: Gray (180).

	CAMDOLLY	CAMDOLLY WITH HANDLE
CODE	CDR2020	CDR2020H
INTERIOR DIMENSIONS	20 ⁷ / ₈ " x 20 ⁷ / ₈ " (53 x 53 cm)	20 ⁷ / ₈ " x 20 ⁷ / ₈ " (53 x 53 cm)
EXTERIOR DIMENSIONS	21 ¹ / ₈ " x 21 ¹ / ₈ " x 8" (54,5 x 54,5 x 20,5 cm)	21 ¹ / ₈ " x 23 ³ / ₈ " x 37" (54,5 x 59,5 x 94 cm)
LOAD CAPACITY	350 lbs (159 Kg)	350 lbs (159 Kg)
CASE LBS. (CUBE)	11.75 (1.14)	21.50 (3.25)
CASE KG (CUBE M ³)	5,3 (0,03)	9,7 (0,1)
LIST PRICE EACH	\$ 160.00	\$ 260.00

Case Pack: 1. Casters: 3¹/₂" (10 cm) casters, 4 swivel, no brakes.

InStock Color: Soft Gray (151).

SELECTING THE RIGHT CAMRACK®

Selecting the Right Camrack®

Cambro offers multiple ways to help you quickly find the right Camrack:

1. Cambro Catalog

Flip to the back of this section for a convenient stemware and glass sizing reference guide.

2. www.cambro.com

Online Glass to Rack guides are accessible from the cambro.com home page. Click on "Camrack Sizing Guides" located below the "Resource Center" heading.

3. Cambro Sales Representatives

Contact your local Cambro representative to assist with specifying Camracks®, dollies and covers to fit your glasses and dishware. To find your local representative, refer to the back section of this catalog, visit www.cambro.com or call Cambro Customer Service at 800 833 3003.

4. Send a Sample to Cambro

Send a sample glass to:

CAMBRO

Customer Service Department

5801 Skylab Road

Huntington Beach, CA 92647

Please be sure to include complete contact information and specify if you need full-size or half-size Camracks.

MEASURING TIPS:

Measure across widest part of glass (diameter).

Measure full height of glass from rim to base.

If width or height fall between two sizes, choose the larger size.

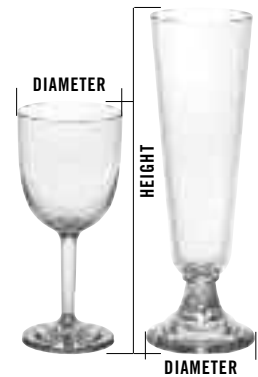

CAMRACK® COMPONENT SYSTEM

The Camrack System offers several choices for ordering the right Camracks and PlateSafe Racks. Please consult with your sales representative or Cambro Customer Service for all special ordering and assembly directions.

Choose Between:

1. A complete selection of pre-assembled, ready to use Camracks listed in our catalog, or
2. Custom built special order Camracks for specific needs, or
3. Individual Camrack components for distributors to stock and build racks as needed.

Base Rack Colors:

Sherwood Green (119), Soft Gray (151), Brown (167), Beige (184), Navy Blue (186), Cranberry (416), Black (110)*, Red (163)*, Blue (168)*, Teal (414)*.

Base Cup Rack Color: Soft Gray (151).

Standard Extender Color: Soft Gray (151).

Optional Extender Color: Beige (184).

PlateSafe Grid Color: Gray (000)

*Full size only.



BR = Full Size Base Rack



HBR = Half Size Base Rack

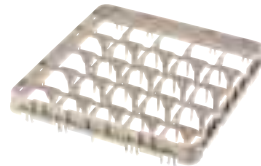

E1 = Full Size Full Drop Compartment Extender



HE1 = Half Size Full Drop Compartment Extender

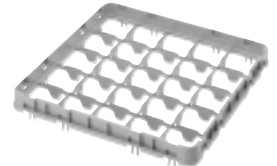

E2 = Full Size Half Drop Compartment Extender



HE2 = Half Size Half Drop Compartment Extender

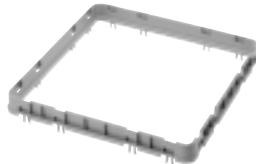

E3 = Full Size Open Extender



HE3 = Half Size Open Extender

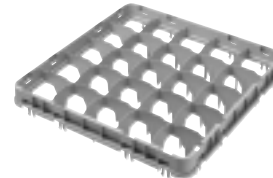

E4 = Full Size Full Drop Stemware Extender

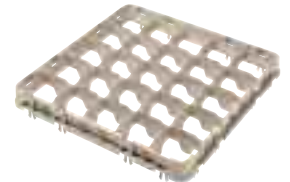

E5 = Full Size Half Drop Stemware Extender

Only E3 extenders may be added to E4's and E5's.

CAMRACK® COMPONENTS

CODE	DESCRIPTION	OVERALL DIMENSIONS	COMPARTMENT	INSIDE RACK HEIGHT	CASE PACK	CASE LBS. (CUBE)	LIST PRICE EA.
Full Size Base Racks							
BR258	Full Base Rack	19 ³ / ₄ " x 19 ³ / ₄ " x 4" (500 x 500 x 101 mm)	18" x 18" (457 x 457 mm)	2 ⁵ / ₈ " (67 mm)	6	21.74 (4.69)	\$ 29.75
Half Size Base Racks							
HBR258	Half Base Rack	19 ³ / ₄ " x 9 ³ / ₈ " x 4" (500 x 250 x 101 mm)	18 ¹ / ₄ " x 8 ³ / ₈ " (464 x 213 mm)	2 ⁵ / ₈ " (67 mm)	6	13.50 (2.70)	20.15
Full Size Base Cup Racks							
16C258	16-Compartment Full Cup Rack	19 ³ / ₄ " x 19 ³ / ₄ " x 4" (500 x 500 x 101 mm)	4 ³ / ₈ " x 4 ³ / ₈ " (111 x 111 mm)	2 ⁵ / ₈ " (67 mm)	6	25.97 (5.35)	32.40
20C258	20-Compartment Full Cup Rack	19 ³ / ₄ " x 19 ³ / ₄ " x 4" (500 x 500 x 101 mm)	4 ³ / ₈ " x 3 ¹ / ₂ " (111 x 89 mm)	2 ⁵ / ₈ " (67 mm)	6	28.79 (5.35)	33.60
Half Size Base Cup Racks							
8HC258	8-Compartment Half Cup Rack	19 ³ / ₄ " x 9 ³ / ₈ " x 4" (500 x 250 x 101 mm)	4 ³ / ₈ " x 4 ¹ / ₁₆ " (105 x 113 mm)	2 ⁵ / ₈ " (67 mm)	6	16.25 (2.77)	23.10
10HC258	10-Compartment Half Cup Rack	19 ³ / ₄ " x 9 ³ / ₈ " x 4" (500 x 250 x 101 mm)	4 ³ / ₈ " x 3 ¹ / ₂ " (105 x 89 mm)	2 ⁵ / ₈ " (67 mm)	6	16.75 (2.77)	23.10
Full Size Full Drop Extenders – E1							
9E1	9-Compartment Full Drop Extender	19 ³ / ₈ " x 19 ³ / ₈ " x 2" (499 x 499 x 51 mm)	5 ⁷ / ₈ " x 5 ⁷ / ₈ " (150 x 150 mm)	1 ¹ / ₈ " (41 mm)	12	24.74 (6.54)	13.70
16E1	16-Compartment Full Drop Extender	19 ³ / ₈ " x 19 ³ / ₈ " x 2" (499 x 499 x 51 mm)	4 ³ / ₈ " x 4 ³ / ₈ " (111 x 111 mm)	1 ¹ / ₈ " (41 mm)	12	23.50 (6.93)	14.50
25E1	25-Compartment Full Drop Extender	19 ³ / ₈ " x 19 ³ / ₈ " x 2" (499 x 499 x 51 mm)	3 ¹ / ₂ " x 3 ¹ / ₂ " (89 x 89 mm)	1 ¹ / ₈ " (41 mm)	12	17.4 (6.76)	15.30
36E1	36-Compartment Full Drop Extender	19 ³ / ₈ " x 19 ³ / ₈ " x 2" (499 x 499 x 51 mm)	2 ⁷ / ₈ " x 2 ⁷ / ₈ " (73 x 73 mm)	1 ¹ / ₈ " (41 mm)	12	28.50 (6.93)	15.60
49E1	49-Compartment Full Drop Extender	19 ³ / ₈ " x 19 ³ / ₈ " x 2" (499 x 499 x 51 mm)	2 ¹ / ₁₆ " x 2 ¹ / ₁₆ " (62 x 62 mm)	1 ¹ / ₈ " (41 mm)	12	31.25 (6.93)	15.60
Full Size Half Drop Extenders – E2							
9E2	9-Compartment Half Drop Extender	19 ³ / ₈ " x 19 ³ / ₈ " x 2" (499 x 499 x 51 mm)	5 ⁷ / ₈ " x 5 ⁷ / ₈ " (150 x 150 mm)	1 ¹ / ₈ " (41 mm)	12	21.59 (6.54)	12.85
16E2	16-Compartment Half Drop Extender	19 ³ / ₈ " x 19 ³ / ₈ " x 2" (499 x 499 x 51 mm)	4 ³ / ₈ " x 4 ³ / ₈ " (111 x 111 mm)	1 ¹ / ₈ " (41 mm)	12	22.25 (6.93)	12.85
20E2	20-Compartment Half Drop Extender (for cups only)	19 ³ / ₈ " x 19 ³ / ₈ " x 2" (499 x 499 x 51 mm)	4 ³ / ₈ " x 3 ¹ / ₂ " (111 x 89 mm)	1 ¹ / ₈ " (41 mm)	12	22.25 (6.93)	11.95
25E2	25-Compartment Half Drop Extender	19 ³ / ₈ " x 19 ³ / ₈ " x 2" (499 x 499 x 51 mm)	3 ¹ / ₂ " x 3 ¹ / ₂ " (89 x 89 mm)	1 ¹ / ₈ " (41 mm)	12	23.25 (6.93)	13.30
36E2	36-Compartment Half Drop Extender	19 ³ / ₈ " x 19 ³ / ₈ " x 2" (499 x 499 x 51 mm)	2 ⁷ / ₈ " x 2 ⁷ / ₈ " (73 x 73 mm)	1 ¹ / ₈ " (41 mm)	12	25.50 (6.93)	14.05
49E2	49-Compartment Half Drop Extender	19 ³ / ₈ " x 19 ³ / ₈ " x 2" (499 x 499 x 51 mm)	2 ¹ / ₁₆ " x 2 ¹ / ₁₆ " (62 x 62 mm)	1 ¹ / ₈ " (41 mm)	12	28.25 (6.93)	14.05

CAMRACK® / PLATESAFE™ COMPONENT SYSTEM

CODE	DESCRIPTION	OVERALL DIMENSIONS	COMPARTMENT	INSIDE RACK HEIGHT	CASE PACK	CASE LBS. (CUBE)	LIST PRICE EA.
Full Size Open Extender – E3							
E3	Open Extender	19½" x 19½" x 2" (499 x 499 x 51 mm)	18" x 18" (457 x 457 mm)	1⅝" (41 mm)	12	16.65 (5.40)	\$ 10.95
Full Size Full Drop Extender – E4							
16E4	16-Compartment Full Drop Extender	19½" x 19½" x 2" (499 x 499 x 51 mm)	4⅞" x 4⅞" (111 x 111 mm)	1⅝" (41 mm)	12	27.50 (6.93)	15.60
25E4	25-Compartment Full Drop Extender	19½" x 19½" x 2" (499 x 499 x 51 mm)	3½" x 3½" (89 x 89 mm)	1⅝" (41 mm)	12	28.7 (6.76)	17.80
36E4	36-Compartment Full Drop Extender	19½" x 19½" x 2" (499 x 499 x 51 mm)	2⅞" x 2⅞" (73 x 73 mm)	1⅝" (41 mm)	12	34.75 (6.93)	20.15
Full Size Half Drop Extender – E5							
16E5	16-Compartment Half Drop Extender	19½" x 19½" x 2" (499 x 499 x 51 mm)	4⅞" x 4⅞" (111 x 111 mm)	1⅝" (41 mm)	12	26 (6.93)	13.75
25E5	25-Compartment Half Drop Extender	19½" x 19½" x 2" (499 x 499 x 51 mm)	3½" x 3½" (89 x 89 mm)	1⅝" (41 mm)	12	28.125 (6.93)	14.95
36E5	36-Compartment Half Drop Extender	19½" x 19½" x 2" (499 x 499 x 51 mm)	2⅞" x 2⅞" (73 x 73 mm)	1⅝" (41 mm)	12	31.64 (6.66)	15.60
Half Size Full Drop Extenders – HE1							
8HE1	8-Compartment Full Drop Extender	19¼" x 9⅞" x 2" (502 x 252 x 51 mm)	4⅞" x 4⅞" (105 x 113 mm)	1⅝" (41 mm)	12	14.25 (3.55)	12.20
10HE1	10-Compartment Full Drop Extender	19¼" x 9⅞" x 2" (502 x 252 x 51 mm)	4⅞" x 3½" (105 x 89 mm)	1⅝" (41 mm)	12	15.25 (3.55)	12.20
17HE1	17-Compartment Full Drop Extender	19¼" x 9⅞" x 2" (502 x 252 x 51 mm)	∅ 2⅝" (∅ 74 mm)	1⅝" (41 mm)	12	17.50 (3.55)	12.70
Half Size Half Drop Extenders – HE2							
8HE2	8-Compartment Half Drop Extender	19¼" x 9⅞" x 2" (502 x 252 x 51 mm)	4⅞" x 4⅞" (105 x 113 mm)	1⅝" (41 mm)	12	14 (3.55)	10.90
10HE2	10-Compartment Half Drop Extender	19¼" x 9⅞" x 2" (502 x 252 x 51 mm)	4⅞" x 3½" (105 x 89 mm)	1⅝" (41 mm)	12	14.75 (3.55)	11.40
17HE2	17-Compartment Half Drop Extender	19¼" x 9⅞" x 2" (502 x 252 x 51 mm)	∅ 2⅝" (∅ 74 mm)	1⅝" (41 mm)	12	16.50 (3.55)	12.20
Half Size Open Extenders – HE3							
HE3	Open Extender	19¼" x 9⅞" x 2" (502 x 252 x 51 mm)	18¼" x 8⅞" (464 x 213 mm)	1⅝" (41 mm)	12	12.25 (3.55)	9.75

∅ = Diameter

PLATESAFE™ CAMRACK GRIDS

CODE	DESCRIPTION	DIMENSIONS	CASE PACK	CASE LBS. (CUBE)	LIST PRICE EA.
Full Size PlateSafe Grids					
CRPG6345	Holds 63 plates, 4"-5"	18" x 18"	12	26.3 (0.92)	\$ 35.05
CRPG2046	Holds 20 plates, 4"-6"	18" x 18"	12	1.29 (0.92)	35.05
CRPG4856	Holds 48 plates, 5"-6"	18" x 18"	12	23.9 (0.92)	35.05
CRPG4467	Holds 44 plates, 6"-7"	18" x 18"	12	23.9 (0.92)	34.30
CRPG3067	Holds 30 plates, 6"-7⅝"	18" x 18"	12	21.79 (0.86)	29.70
CRPG2878	Holds 28 plates, 7"-8⅞"	18" x 18"	12	19.7 (0.92)	24.35
CRPG20910	Holds 20 plates, 9"-10¼"	18" x 18"	12	19.93 (0.92)	28.35
CRPG12910	Holds 12 plates, 9"-10½"	18" x 18"	12	15.91 (0.92)	20.35
CRPG12911	Holds 12 plates, 9"-11⅞"	18" x 18"	12	17.71 (0.85)	20.65
CRPG9911	Holds 9 plates, 9"-11"	18" x 18"	12	14.53 (0.86)	24.65
CRPG191011	Holds 19 plates, 10"-11"	18" x 18"	12	18.5 (0.92)	26.85
CRPG141012	Holds 14 plates, 10½"-12½"	18" x 18"	12	17.29 (0.82)	25.50
CRPG181112	Holds 18 plates, 11"-12½"	18" x 18"	12	19.1 (0.92)	28.70
Half Size PlateSafe Grid					
CRPHG1656	Holds 16 plates, 5"-6⅞"	18¼" x 8⅞"	12	13 (0.42)	28.05
PlateSafe Hold Down Grid					
CRPHDG2878	Fits all full size base racks	18" x 18"	6	10.15 (0.46)	25.85

Base Rack Colors: Sherwood Green (119), Soft Gray (151), Brown (167), Beige (184), Navy Blue (186), Cranberry (416), Black (110)*, Red (163)*, Blue (168)*, Teal (414)*.
Base Cup Rack Color: Soft Gray (151). **Extender Colors:** Soft Gray (151), Beige (184). All extenders are available in gray and beige. All pre-assembled racks ship with gray extenders unless otherwise specified. *Color available in full size only.

Pre-assembled beige base racks with beige extenders can be ordered by specifying SC (same color) in the product code. Example: 36GSC414184. All other pre-assembled Camracks may be ordered with beige extenders and must be entered as special orders. Sherwood Green, Brown, Navy Blue and Cranberry base racks can be ordered with same color extenders with a minimum special order of 600 racks.

PlateSafe Grid Colors: Gray (000)

LET'S GET PERSONAL – PERSONALIZED CAMRACKS®

Personalize Camracks to identify contents at a glance for accurate inventory control and selection.

Hot stamp a custom logo, information or standard content symbols and/or descriptions on two opposite sides of any rack.

Or request the addition of pre-printed clips. Up to 4 Camrack or PlateSafe clips can be added **only at time of assembly** and require the use of at least one extender.



IMPRINT COLOR-WHITE



PERSONALIZATION OPTIONS

HOT STAMPING

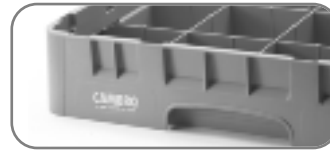

CUSTOM LOGO AND/OR TEXT

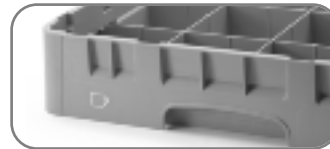

STANDARD SYMBOL ONLY

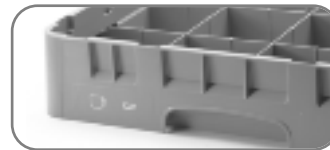

STANDARD SYMBOL AND DESCRIPTION

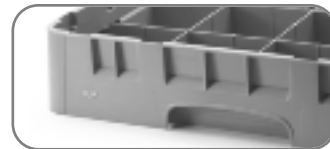

STANDARD DESCRIPTION ONLY

CAMRACK CLIPS



WITH SYMBOL AND DESCRIPTION

HOW TO ORDER A SAMPLE

1. Contact your local Cambro rep to complete and submit a sample request form to Cambro. Indicate location of hot stamp and or clip on rack. Maximum hot stamp imprint size is 4" W x 1 1/4" H. Maximum hot stamp imprinting thickness per solid letter or logo should be no more than 4" wide.
2. If selecting custom hot stamping, provide ready to use artwork, digital format only. Sample request form must be submitted to Cambro **PRIOR** to artwork being sent. If artwork is incomplete, graphic support services are available for \$50.00 per hour.
3. E-mail artwork to Cambro Rep or to Cambro at letsgetpersonal@cambro.com. Title e-mail subject with logo name and provide contact info. **File dimensions:** 100% reproduction size, 300dpi resolution. **File type:** Adobe® Illustrator®, Photoshop®, or QuarkXpress®. **File format:** JPEG, TIFF and EPS. Or mail artwork on a CD-ROM to: Cambro Manufacturing Company Attn: Kristie Patterson, 7601 Clay Avenue, Huntington Beach, CA 92648.
4. Questions? Contact Kristie Patterson at 714-230-4125 direct or 800-854-7631 ext. 4125.
5. Signed approval form must be faxed to Cambro customer service prior to producing product. Approval form included with each sample rack.

PERSONALIZATION CHARGES (NET)

One Time Plate Charge	\$75.00 (for custom hot stamp only)
Set-Up Charge	\$50.00
Sample Charge	\$50.00
Imprint Charge	\$1.00 per side, 2 sides max.

FOR CLIPS

Drinkware or PlateSafe, pre-printed	\$0.90 each net
-------------------------------------	-----------------

STANDARD HOT STAMP SYMBOLS AND/OR DESCRIPTIONS

(also available on clips, symbol and description combined)



(Available in English Only)

STANDARD PLATESAFE® CLIPS

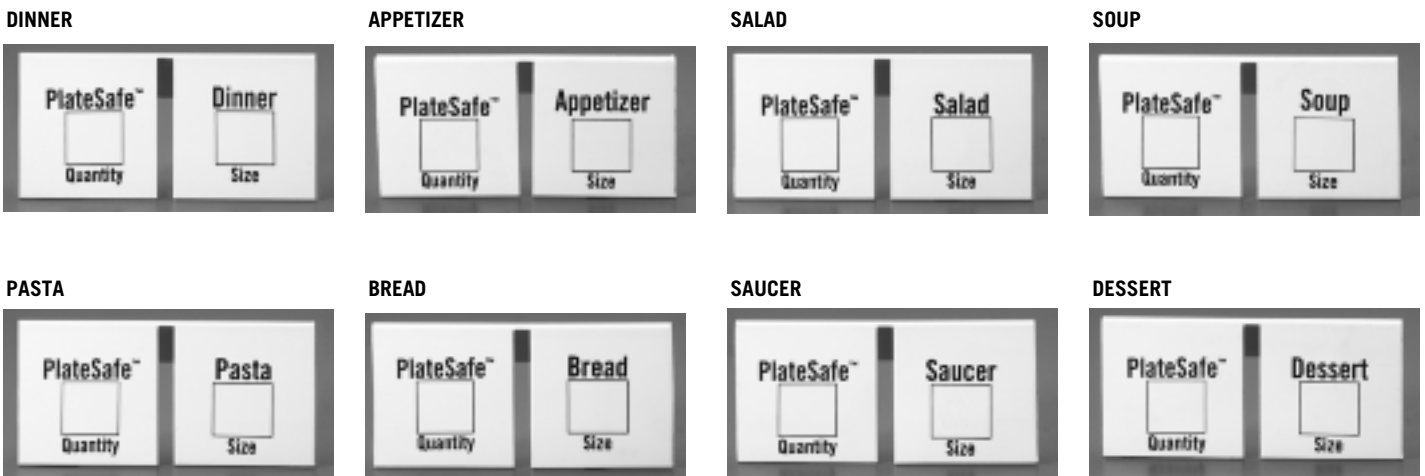

(Available in English Only)

STEMWARE AND GLASS SIZING REFERENCE GUIDE

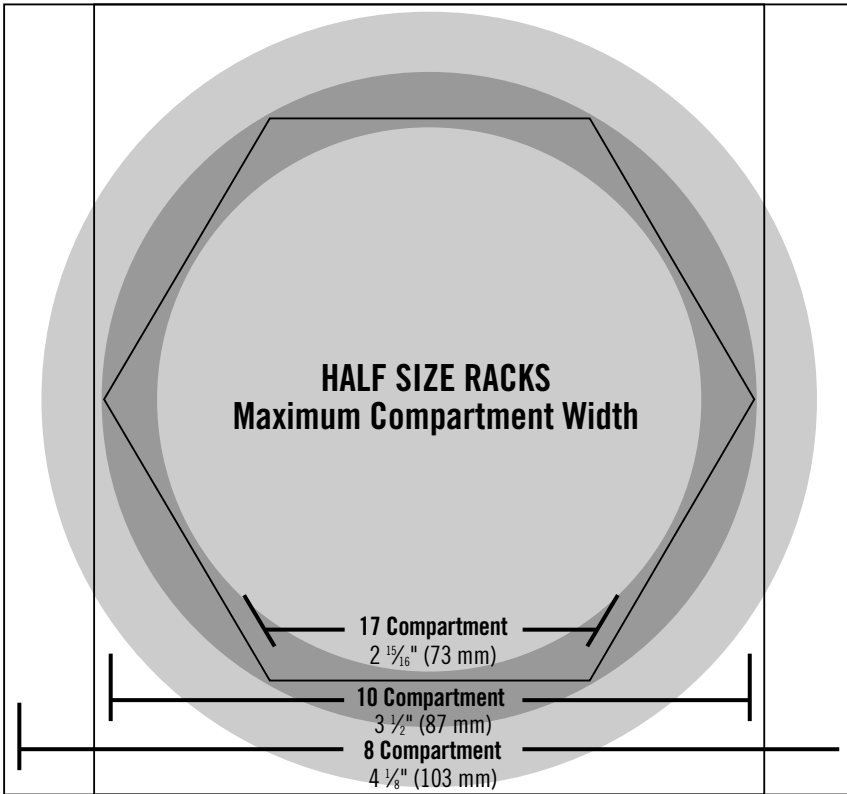

To Determine Compartment Size

- **Half Size Racks:** Place glass or stemware upside down over circle chart. Look down on the glass. Whatever circle the largest diameter of the glass fits within will determine the number of compartments.
- **Full Size Racks:** Place glass or stemware upside down over circle chart. Look down on the glass. Whatever circle the largest diameter of the glass fits within will determine the number of compartments.

Use the vertical guide marks at right to determine item height and appropriate rack number. 

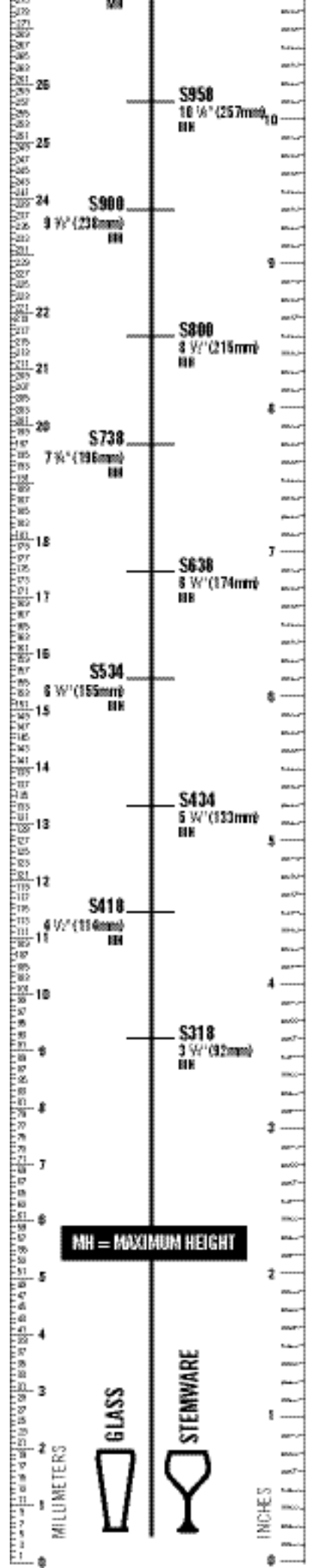
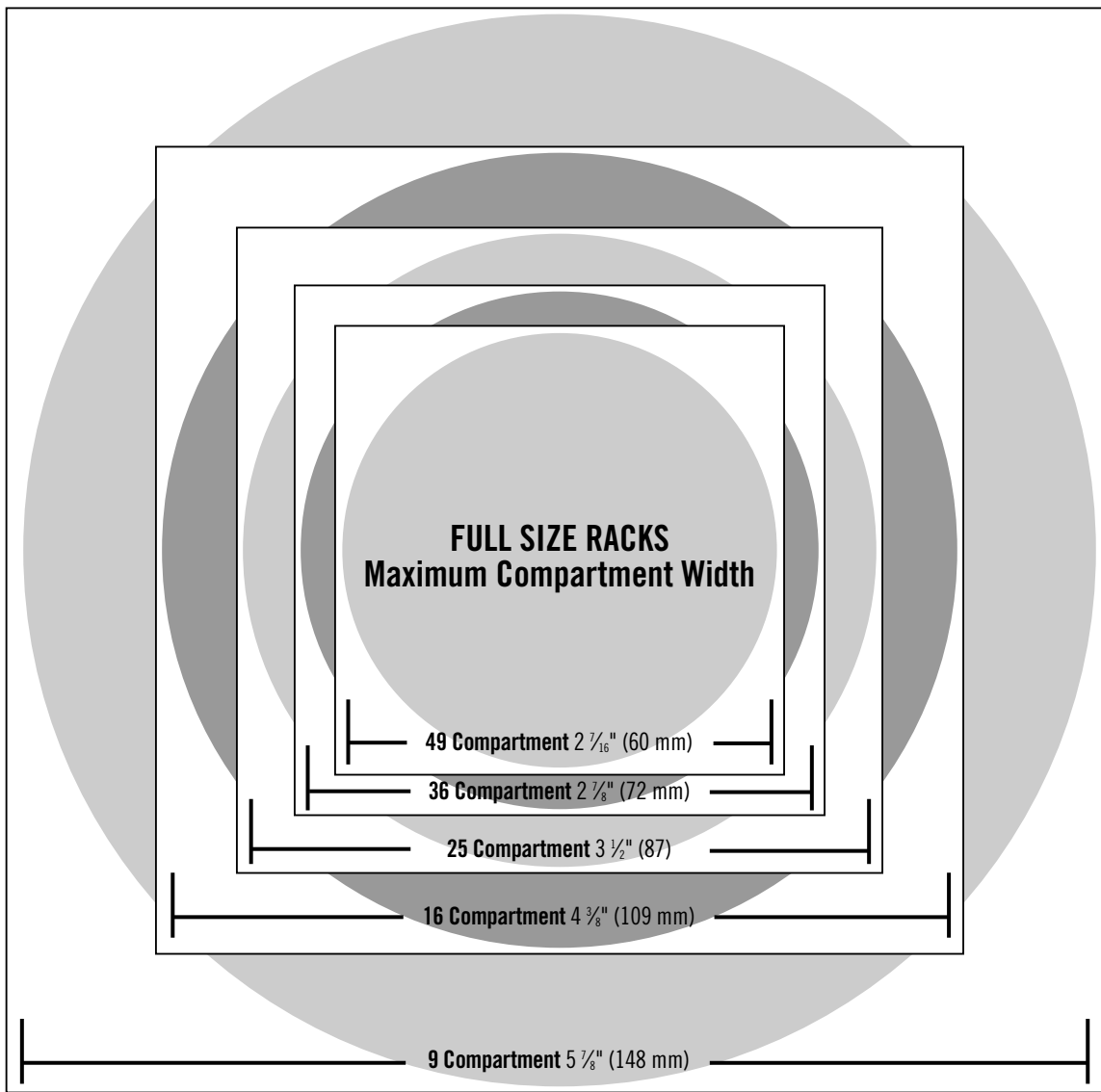

CAMRACK® CUP RACK REFERENCE GUIDE



16

FULL RACK

COMPARTMENT

4 3/8" x 4 3/8" (111 x 111 mm)

To determine Cup compartment size:
Turn cup or coffee mug upside down and place diagonally in square. Align handle with arrow in square. Cup or mug and handle must fit completely within boundaries of a square in order to ensure the right rack.



20

FULL RACK

COMPARTMENT

4 3/8" x 3 1/2" (111 x 89 mm)

QUICK GUIDE

Full Size Cup Racks (C)

Maximum Cup Width	Number of Compartments	Maximum Cup Height		
		2 1/4" (67 mm)	4 1/4" (109 mm)	5 1/4" (140 mm)
4 1/8" (111 mm)	16	16C258	16C414	16C578
3 1/2" (89 mm)	20	20C258	20C414	NA



10

HALF RACK

COMPARTMENT

4 1/8" x 3 1/2" (105 x 89 mm)



8

HALF RACK

COMPARTMENT

4 7/16" x 4 1/8" (113 x 105 mm)

QUICK GUIDE

Half Size Cup Racks (HC)

Maximum Cup Width	Number of Compartments	Maximum Cup Height	
		2 1/4" (67 mm)	4 1/4" (109 mm)
4 1/8" (106 mm)	8	8HC258	8HC414
3 1/2" (89 mm)	10	10HC258	10HC414

To determine Cup height:

Place base of cup or coffee mug on flat surface hold ruler vertically next to it to determine height in inches or millimeters. If the height is greater than 4 1/4" (108 mm), additional 1 1/8" (41 mm) E2 and HE2 extenders may be ordered.

CAMBRO® U.S.A. REPRESENTATIVES



U.S.A. Cambro Regional Offices

Florida
Tel: 954/341-0177
Fax: 954/341-5408
jdenoble@cambro.com

Kentucky and Southern Ohio
Tel: 513/895-0429
tmoriarty@cambro.com

New England
Tel: 603/770-5361
dallard@cambro.com

Northern Ohio
Tel: 614/447-8598
jpalko@cambro.com

Texas & Oklahoma
Tel: 817/282-6993
jjstrawther@cambro.com

CLVMarketing
Metro New York / Northern New Jersey
Tel: 631/694-7170
Fax: 631/694-7243
sales@clvmarketing.com
www.clvmarketing.com

U.S.A. Central Marketing Associates, Inc.

SHAWNEE MISSION, KS
Tel: 913/897-2390
888/414-6996
Fax: 913/897-2391
ST. LOUIS, MO
Tel: 636/493-2200
Fax: 636/493-2201
Norwalk, IA
Tel: 515/981-9897
Fax: 515/981-9712
www.cmafoodservice.com

Crystal Concepts
Annapolis, MD
Tel: 410/349-2284
866/349-2286
Fax: 410/349-2285
MD/DC/VA
www.crystalconcepts.net

Daly & DeRoma Group, Inc.
Plymouth, MN
Tel: 763/543-8080
Fax: 763/543-8181
MN/ND/SD
Tel: 877/325-9477
www.dalyderoma.com

U.S.A.
EMi Marketing, Inc.
Denver, CO
Tel: 303/797-2241
Toll Free: 800/338-8131
Fax: 303/797-6641
Albuquerque, NM
Tel: 505/265-5878
Fax: 505/265-5891
Bozeman, MT
Tel: 406/539-1982
Fax: 406/586-7040
cambro@emimarketing.com

Robert Emig & Associates
Pittsburgh, PA
Tel: 412/635-9909
Fax: 412/635-9908
Buffalo, NY
Tel: 585/259-6865
Fax: 585/388-6046
Syracuse, NY
Tel: 315/559-4412
Fax: 315/696-4697
sales@emigandassoc.com
www.emigandassoc.com

U.S.A.
The Fischer Group
Orange, CA
Tel: 714/921-2660
Fax: 714/921-2544
San Diego, CA
Tel: 714/921-2660
Las Vegas, NV
Tel: 702/250-8240
www.fischergroup.com

Gabriel Group, Inc.
Grand Rapids, MI
Detroit, MI
Fort Wayne, IN
Indianapolis, IN
Tel: 616/656-5100
800/332-3701
Fax: 616/656-8004
info@gabrielgrp.com

The Hansen Group
Duluth, GA
Tel: 770/667-1544
Fax: 770/667-1491
Alabama/Tennessee/Georgia/
Florida Panhandle
sales@thehansengroup.net
www.thehansengroup.net

CAMBRO® U.S.A. REPRESENTATIVES

U.S.A.

Jones-McCormick, Inc.

Charlotte, NC
Tel: 704/344-1101
Fax: 704/344-1764
Raleigh, NC
Tel: 919/762-1256
Tel: 910/592-8967
Columbia, SC
Tel: 803/635-3543
www.jones-mccormick.com

M.K. Food Service Equipment, Inc.

Philadelphia, PA
Tel: 215/471-4700
800/654-0505
Fax: 215/471-8916
www.markkurm@mkfoodservice.com

MarkeTeam

Vancouver, WA
Tel: 360/696-3984
FAX: 360/693-0192
info@marketeamnw.com
www.marketeamnw.com
Seattle, WA
Tel: 425/260-2410
Honolulu, HI
Tel: 808/282-8957

MarketSmart, Inc.

Pleasanton, CA
Tel: 925/846-6237
Fax: 925/846-2602
www.marketsmartinc.com

Miller & Stryker Associates, Inc.

Wood Dale, IL
Tel: 630/766-0077
800/301-1431
Fax: 630/766-8777
pstryker@millerandstryker.com

PowerLink Rep Group

Mesa, AZ
Tel: 480/816-1000
Fax: 480/816-1200
jeanvermilyea@msn.com

U.S.A.

The Wallin Group, Inc.

New Orleans, LA
Tel: 504/733-3344
Fax: 504/733-0854
Memphis, TN
Tel: 901/370-4724
Fax: 901/370-4734
Jackson, MS
Tel: 601/992-7260
Fax: 601/992-7350
Little Rock, AR
Tel: 501/663-2438
Fax: 501/663-2439
www.wallingroup.com

Wasatch Mountain Marketing, Inc.

Salt Lake City, UT
Tel: 801/328-0712
Fax: 801/328-0742
jeff@utahreps.com

Woolsey & Associates, Inc.

Waukesha, WI
Tel: 262/436-0102
800/383-2524
Fax: 262/436-0109
kim@woolseyassociates.com
www.woolseyassociates.com

MEXICO, CENTRAL AMERICA, CARIBBEAN

Johnson Sales Company

Hollywood, FL
Tel: 954/927-3900
Fax: 954/927-3909
johnson@johnsonsalesco.com

CANADA

R Henry & Associates

(Provinces of Ontario,
excluding Ottawa & the Lakehead)
Toronto, Ontario M8Z 5T7
Tel: 416/259-9100
Fax: 416/251-3732
kwillemse@rogers.com

Les Agences A.M.S.

(Province of Quebec & Ottawa)
Chateauguay, QC J6J 4Z2
Tel: 450/698-1572
Fax: 450/698-2216
lesagencesams@qc.aira.com

Montpellier & Associates

(Province of Alberta)
Spruce Grove, AB T7Y 1C6
Tel: 780/987-2278
Fax: 780/987-2279
Calgary, AB T2X 3W1
Tel: 403/618-3636
Fax: 403/203-9190
paulmont@tbwifi.ca

CANADA

Nicholles Enterprises

(Province of British Columbia)
Maple Ridge, BC V2X 2N6
Tel: 604/465-0392
Fax: 604/465-9223
www.nicholles.com

Norquip Agencies, Ltd.

(Provinces of Manitoba, Saskatchewan
plus Thunder Bay, Ontario)
Winnipeg, Manitoba R2N 1G4
Tel: 204/253-4675
Fax: 204/254-2597
hearn@mts.net

Taylor Agencies Ltd.

(Atlantic Provinces)
Tel: 877/861-4866
Fax: 902/861-2503
aaron@tayloragencies.com

CAMBRO® INTERNATIONAL REPRESENTATIVES



AFRICA

AFRICA

Cambro Africa (North East)

Paul Micallief
Regional Sales Manager
Tel: 00971 50 45 98 246
Fax: 00971 4 361 9414
cambronorthafrica@cambro.com
Territories: Egypt, Libya

Cambro Africa (French speaking)

Nicolas Rouas
Regional Sales Manager
Tel: 33 676 062469
nrouas@cambro.com
Territories: Algeria, Cameroon, Ivory Coast, Morocco, Senegal, Tunisia

Cambro Africa

Ken French
Regional Sales Manager
kfrench@cambro.com
Territories: South of the Tropic of Cancer including West, East, Central and Southern Africa, Indian Ocean Islands

MAURITIUS

Coroi Maurice Ltée

Grewals Lane, Pailles, Mauritius
Tel: (230) 286 3333
Fax: (230) 286 3336
equipment@coroimu.com

SOUTH AFRICA

Commerical Catering Equipment (CCE)

Northriding, South Africa
Tel: (27) 11 796-5008
Fax: (27) 11 796-5009
cambro@ccesa.co.za
www.ccesa.co.za

ASIA/EAST ASIA

CHINA

Huizhou Cambro Commerce Co.

Huizhou, China 516008
Tel: 86-752 238-7829
Fax: 86-752-238-7019
achen@cambro.com
www.cambro.com

Shanghai Pro-Gent Trading Co., Ltd.

Shanghai 200051 China
Tel: (86) 21-5253-1518
Fax: (86) 21-5253-0419
Jinqi-pg@suo-ma.com
www.suo-ma.com

Guang Dong Sheng Nan Trading Co., Ltd.

Guangzhou 510300 China
Tel: (8620) 89885511
Fax: (8620) 89885501
Linsuixiang-sn@suo-ma.com
www.suo-ma.com

Shenzhen Mega-Resources Hotel Supply Co., Ltd.

Shenzhen 518111 China
Tel: (86) 755-8466-1888
Fax: (86) 755-3382-5666
zny@zny.cn
www.zny.cn

Guangzhou Sanyi Kitchen Equipment Company

Guangzhou, 51000 China
Tel: (86) 20-3423-4658
Fax: (86) 20-3423-4825
sanyi1982@163.com
www.gzsanyi.cn

ASIA/EAST ASIA

CHINA

Sunpek Trading Co., Ltd.

Beijing 100089 China
Tel: (86) 10-6845-7151
Fax: (86) 10-6841-1721
Wangyang-sp@suo-ma.com
www.suo-ma.com

Beijing National Tourism Trading & Service Company

Hotel Equipment & Supplies Branch
Beijing, 100016 China
Tel: (86) 10-6432-4595
Fax: (86) 10-6432-7834
tomxiong@canttsc.com
www.canttsc.com.cn

San Neng Bake Ware (Wuxi) Co., Ltd.

Wuxi 214191 China
Tel: (86) 510-8377-3057
Fax: (86) 510-8377-5476
yewu@wxnanneng.com
www.suo-ma.com

Shanghai Angelhood Co., Ltd.

Shanghai 201109 China
Tel: (86) 21-5159-3060
Fax: (86) 21-5168-7575
freeman@angelhood.com.cn
www.angelhood.com.cn

HONG KONG/CHINA

Well-In Hotel Supplies Co., Ltd.

Tsimshatsui, Kowloon Hong Kong
Tel: (852) 2735-0532
Fax: (852) 2730-8514
wellin@wellinhk.com

Other branches in:

Beijing office:

Tel: 010-64810527
Shanghai office:
Tel: 021-52397279
Guangzhou office:
Tel: 020-87359177

HONG KONG

SANYO Electric (Hong Kong) Limited

North Point, Hong Kong
Tel: (852) 2566-3456
Fax: (852) 2887-9545
(852) 2979-4092
albert@sanyocri.com

SOUTH EAST ASIA

Cambro - South East Asia

Jeff Sohn
National Sales Director
Tel: (82) 10 7152 5043
Fax: (82) 2 903 1613
jsohn@cambro.com
Territories: Korea, Indonesia, Malaysia, Phillipines, Singapore, Thailand, Vietnam

INDONESIA

PT. Hocatsu Pratama Indonesia

Jakarta 14420, Indonesia
Tel: (6221) 6455278
Fax: (6221) 6404839
sales@hocatsupratama.com

PT. Hocatsu Bali

Kuta 80361, Bali
Tel: (62 361) 766 638
Fax: (62 361) 766 639
hocastubali@telkom.net

CAMBRO® INTERNATIONAL REPRESENTATIVES

SOUTH EAST ASIA

JAPAN

EBM Co., Ltd

Tsubameshi, Niigataken
Japan 959-1277
Tel: (81) 256-63-2569
Fax: (81) 256-66-4766
ebm@ebematsu.co.jp
www.ebematsu.co.

TKG Corporation

Tsubame-City, Niigata-Pref, Japan
Tel: (81) 256-61-1550
Fax: (81) 256-66-1777
sales@tkg-corp.com

Epic Corporation

Minato-ku, Tokyo 108-0022, Japan
Tel: (81) 3-5484-6711
Fax: (81) 3-5484-2577
c-kobana@epic-co.com

KOREA

Cambro Korea

Jeff Sohn
National Sales Director, Korea
Tel: (82) 10 7152 5043
Fax: (82) 2 903 1613
jsohn@cambro.com

A-Ju Foodservice

Dongkyo-Dong, Seoul, Korea
Tel: (82) 02-755-4993
Fax: (82) 02-756-4994
cook@ajupro.co.kr

Bi-Max International

Jamwon-Dong, Seoul 137-903, Korea
Tel: (82) 02 516 4731
Fax: (82) 02-516-4732
bimax@bimax.co.kr

Shinkang Corporation

Seongsoo-Dong, Seoul, Korea
Tel: (82) 02-461-1637
Fax: (82) 02-461-1639
trifoglio@shinkang.net

MALAYSIA

Hocatsu (M) Sdn Bhd

46150 Petaling Jaya, Malaysia
Tel: (603) 5633 4588
Fax: (603) 5634 4589
enquiry@hocatsu.com.my

F&B Equipment Sdn Bhd

58200 Kuala Lumpur, Malaysia
Tel: (603) 7980 8488
Fax: (603) 7981 7377
sales@fnbequipment.com.my

PHILIPPINES

KLG International, Inc.

Foodservice Division

Pasay City, Metro Manila 1300,
Philippines
Tel: (63) 2-833-2288
Fax: (63) 2-832-5880
info@klgfoodservice.com.ph
www.KLGfoodservice.com.ph

ASIA/EAST ASIA

SINGAPORE/INDONESIA/MALAYSIA

Sia Huat Pte Ltd. -

Regional Master Distributor

Corporate Sales:
Singapore 609272
Tel: (65) 62683922
Fax: (65) 62662796
enquiry@siahuat.com.sg
www.siahuat.com.sg

Retail Sales:

Singapore 058559
Tel: (65) 62231732
Fax: (65) 62242896

TAIWAN

San Hwa Harn Co., Ltd./

Emperor Global Co., Ltd.

Taipei, Taiwan
Tel: (886) 2-2973-3918
Fax: (886) 2-2973-4132
emp666@ms26.hinet.net

FECO Corporation

Taipei, Taiwan
Tel: (886) 2-2758-2288
Fax: (886) 2-2758-2297
fecotp@ms14.hinet.net
www.feco-corp.com.tw

THAILAND

E.S. Bangkok Co., Ltd.

Samutprakarn 10540, Thailand
Tel: (662) 753 7880
Fax: (662) 710 2830
esbkk@isdn.loxinfo.com

Seven-Five Distributor Co., Ltd.

Bangkok 10700, Thailand
Tel: (66) 2-866-5858
Fax: (66) 2-412-5394
virat@sevenfive.net

Evergreen Intertrade Co., Ltd.

Bangkok 10600, Thailand
Tel: (662) 440-0091 (6 lines Auto)
Fax: (662) 440-0097 / 0098
evergrn@asiaaccess.net.th

VIETNAM

Classique Restaurant & Hotel

Supplies PTY. Limited

Ho Chi Minh City, Vietnam
Tel: (848) 8230-363
Fax: (848) 8230-363
classique@hcm.vnn.vn

Q Industries & Trade Co., Ltd.

Ho Chi Minh City, Vietnam
Tel: (848) 930-6942
Fax: (848) 930-6944
salesvn@qindustries.com
www.qindustries.com
Other branches in:
Hanoi
Tel: (844) 771-4425
Fax: (844) 771-4426

ASIA/EAST ASIA

VIETNAM

Andy Mannhart Vietnam

Dan & Dan Co., Ltd.
HCMC, Vietnam
Tel: (848) 5500 146
Fax: (848) 5500 145
vietnam@andymannhart.com
dan.dan.hotelsupplies@gmail.com

EUROPE

Cambro European Logistics (CEL)

NL-4761 RL Moerdijk,
The Netherlands
Tel: 31-168-413-333
Fax: 31-168-414-033
cambroeuropa@cambro.com
Toll # from Ireland: 1-800-50-9046
Toll # from N. Ireland and UK:
0-800-587-0057
Toll # from France: 0800-91-08-78
www.cambro.com

AUSTRIA

Cambro - PK Austria

A-6020 Innsbruck, Austria
Tel: (43) 512-292-051
Fax: (43) 512-295-896
cambroaustria@cambro.com

BELGIUM

Interhal Benelux B.V.

2952 BG Alblasterdam,
The Netherlands
Tel: (31) 78-6992-990
Fax: (31) 78-6992-998
cambrobelgium@cambro.com
www.interhal.nl

CROATIA

Tehno Val

51512 Njivice, Croatia
Tel: (385) 51 846257
Fax: (385) 51 846257
cambrocroatia@cambro.com
www.tehno-val.hr

CYPRUS

Vanora Industries, Ltd.

Limassol, Cyprus
Tel: 357 25 564 186
Fax: 357 25 573 476
vanora@spidernet.com.cy

DENMARK

Hotri Storkøkken

DK-2730 Herlev, Denmark
Tel: (45) 3-641-2800
Fax: (45) 3-641-3229
cambrodenmark@cambro.com
www.hotri.dk

Bent Brandt AS

DK-8200 Århus N, Denmark
Tel: (45) 89-30-00-00
Fax: (45) 89-30-00-02
bb@bentbrandt.dk
www.bentbrandt.dk

EUROPE

FINLAND

Dieta Oy/Heres

00880 Helsinki, Finland
Tel: (358) 9755 190
Fax: (358) 9755 19200
cambrofinland@cambro.com
www.dieta.fi

FRANCE

Cambro France Plateforme (CFP)

78190 Trappes, France
Tel: (33) 174907907
Fax: (33) 174907906
commercial@cambro-cfp.com

Cambro European Logistics (CEL)

NL 4761 RL Moerdijk,
The Netherlands
Tel: 0800 910878
Fax: (33) 172703582
cambrofrance@cambro.com

GERMANY

Presswerk Köngen GmbH

Wertstraße 36, Germany
Tel: (49) 7024-9721-0
Fax: (49)7024-9721-19
cambrogermany@cambro.com

GREECE

Yalco

14564 Athens, Greece
Tel: (30) 2106 299 999
Fax: (30) 2108 000 866
athens@yalco.gr
www.yalco.gr
Other branches in:
Kalahori, Thessaloniki
Tel: (30) 2310 573 300
salonika@yalco.gr
Crete
Tel: (30) 2810 301200-301208
crete@yalco.gr
Rhodes
Tel: (30) 22410 72951
rhodes@yalco.gr

HUNGARY

Kadas & Co. Kft.

1224 Budapest, Hungary
Tel: (36) 1-362-6515
Fax: (36) 1-362-6097
cambrohungary@cambro.com
www.kadasco.hu

ICELAND

A. Karlsson hf.

203 Kópavogur, Iceland
Tel: (354) 5600-900
Fax: (354) 5600-901
cambroiceland@cambro.com
www.akarlsson.is

Fastus ehf.

108 Reykjavic, Iceland
Tel: 354-580-3900
Fax: 354-843-3922
fastus@fastus.is

CAMBRO® INTERNATIONAL REPRESENTATIVES

EUROPE

IRELAND

Cambro Ireland

North Ireland
Tel: (028) 4067411772
Fax: (028) 4067411772
cambroireland@cambro.com
www.cambro.com

ISRAEL

Beth Matechet L.T.D.

Master Distributor
Tel Aviv, 67014, Israel
Tel: (972) 35626685
Fax: (972) 35626985
b-m@b-m.co.il
www.b-m.co.il

ITALY

FSG Italia srl

42049 S. Ilario d'Enza (RE), Italy
Tel: (39) 0522-90-20-51
Fax: (39) 0522-90-20-17
cambroitaly@cambro.com
www.fsg-italia.it

LATVIA

Gemoss SIA

Riga LV1004, Latvia
Tel: (371) 762 7767
Fax: (371) 770 2777
cambrolatvia@cambro.com
www.gemoss.lv

LITHUANIA

UAB Manjana

LT-48313 Kaunas, Lithuania
Tel: (370) 37 361432
Fax: (370) 37 363245
cambrolithuania@cambro.com
www.manjana.lt

LUXEMBURG

Interhal Benelux B.V.

2952 BG Alblasserdam,
The Netherlands
Tel: (31) 78-6992-990
Fax: (31) 78-6992-998
cambroluxemburg@cambro.com
www.interhal.nl

NETHERLANDS

Interhal Benelux B.V.

2952 BG Alblasserdam,
The Netherlands
Tel: (31) 78-6992-990
Fax: (31) 78-6992-998
cambronetherlands@cambro.com
www.interhal.nl

de Rijk Magazijnrichting BV

Camsheiving Distributor
2665 NT Bleiswijk, Netherlands
Tel: (31) 79-3611311
Fax: (31) 79-3611226
info@derijkmag.nl
www.derijkmag.nl

EUROPE

NORWAY

Horeka A/S

N-3531 Krokkleiva, Norway
Tel: (47) 32-16-20-00
Fax: (47) 32-16-20-01
cambornorway@cambro.com
www.horeka.no

Culina/Enor A/S

N-1396 Billingstad, Norway
Tel: (47) 66 98 32 50
Fax: (47) 66 98 32 51
enor@culina.no
www.culina.no

POLAND

Loba International (Poland)

53-206 Wroclaw, Poland
Tel: 48 (0) 70 790 5511
Fax: 48 (0) 71 791 5512
dloba@international.com
www.lobainternational.com

Alva Sp. z o.o.

53-514 Wroclaw, Poland
Tel: (48) 71 334 6520
Fax: (48) 71 334 6522
cambropoland@cambro.com
www.alva.com.pl

PORTUGAL

Comeca-Exportação e Importação S.A.

2635-022 Rio de Mouro, Portugal
Tel: (351) 219 155 600
Fax: (351) 219 155 661
cambroportugal@cambro.com
www.comeca.pt

ROMANIA

Bilancia

Ilfov 077067, Romania
Tel: 40 (0) 21-352 88 88
Fax: 40 (0) 21-352 33 33
cambromania@cambro.com
www.bilancia.ro

RUSSIA

Trade Design

Moscow, 125130, Russia
Tel: (7) 095 787 4077
Fax: (7) 095 787 4077
cambrorussia@cambro.com
www.trade-design.ru

Loba International (Russia)

Moscow, Russia
Tel/Fax: 7 498 602 5050
Mobile: 7 903 189 1569
dloba@international.com
www.lobainternational.com

SERBIA & MONTENEGRO

Catering d.o.o.

Belgrade 0381 Serbia & Montenegro
Tel: (381) 11 3544 012
Fax: (381) 11 3544 012
cambroserbia@cambro.com
www.catering-hotel.com

EUROPE

SLOVAKIA & CZECH REPUBLIC

DAVAC spol. s r.o.

851 01 Bratislava, Slovak Republik
Tel: (421) 2-63-838-249
Fax: (421) 2-63-838-496
cambroslovakia@cambro.com
cambroczechrepublic@cambro.com
www.davac.sk

SPAIN

DBMARK S.L.

28691 Madrid, Spain
Tel: (900) 122-125 Toll Free
Fax: (34) 91 812 5582
cambrospain@cambro.com
www.dbmark.com

SWEDEN

Cambro Sweden

Stockholm, SE-104 32 Sweden
Tel: (46) 8 545 946 55
Fax: (46) 8 545 945 50
cambrosweden@cambro.com

Idesta Kök

63 180 Eskilstuna, Sweden
Tel: (46) 16 54 04 100
info@idesta.se
www.idesta.se

SWITZERLAND

DEUTSCH SCHWEIZ

Presswerk Köngen GmbH

73240 Wendlingen, Germany
Tel: (49) 7024 9721 0
Fax: (49) 7024 9721 19
cambrodeutshswitzerland@cambro.com

SWITZERLAND

Capro GmbH

4414 Füllinsdorf
Tel: (41) 61 905 20 10
Fax: (41) 61 905 20 15
ruth.schmidlin@capro.ch
www.capro.ch

Andy Mannhart

CH-6403 Kussnacht am Rigi,
Switzerland
Tel: (41) 41 845-2000
Fax: (41) 41 845-2002
info@andymannhart.com

SWITZERLAND

SUISSE ROMANDE

Cambro European Logistics (CEL)

Plateforme Européenne de Distribution
Tel: (31) 168 413 333
Fax: (31) 168 414 033
cambroromandeswitzerland@cambro.com

TICINO

F.S.G. Italia srl

42049 S. Ilario d'Enza, Italy
Tel: (39) 0522-90-20-51
Fax: (39) 0522-90-20-17
cambroticinoswitzerland@cambro.com
www.fsg-italia.it

EUROPE

SWITZERLAND

Stäheli AG

Camsheiving Distributor
CH-8472 Seuzach, Switzerland
Tel: (41) 52-338-04-05
Fax: (41) 52-338-01-24
contact@staeheliag.ch

TURKEY

ÖZAY Servis Ekipmanlari SAN. TIC. A.S.

Istanbul, Turkey
Tel: (90) 212 279 2699
(90) 212 325 3639
Fax: (90) 212 279 2698
ozay@ozayservis.com
www.ozayservis.com

UKRAINE

Food Technics

03049 Kiev, Ukraine
Tel: (380) 44 2411183
Fax: (380) 44 2411183
cambroukraine@cambro.com
www.foodtechnics.com.ua

UNITED KINGDOM

Foodservice Equipment Marketing Ltd.

Master Distributor
East Kilbride, Nr. Glasgow, United Kingdom
Tel: (44) 1355 244111
Fax: (44) 1355 241471
sales@fem.co.uk
www.fem.co.uk

Cambro European Logistics (CEL)

NL-4761 RL Moerdijk,
The Netherlands
Tel: (0800) 5 870 057
Fax: (0845) 2 803 411
cambrouk@cambro.com
www.cambro.com

CENTRAL/EASTERN EUROPE

Loba International

Poland office (main office):
53-206 Wroclaw Poland
Tel: (48) 71 791 5511
Fax: (48) 71 791 5512
Loba International (Russia)
Moscow, Russia
Tel/Fax: 7 498 602 5050
Mobile: 7 903 189 1569
dloba@international.com
www.lobainternational.com
USA office:
Tucson, AZ 85737
Tel: (520) 579 8993
Fax: (520) 579-8997
dloba@cambro.com
dloba@lobainternational.com
www.lobainternational.com

Territories: Azerbaijan, Belarus, Bosnia, Bulgaria, Croatia, Estonia, Georgia, Kazakhstan, Latvia, Lithuania, Moldova, Montenegro, Poland, Romania, Russia, Serbia, Slovenia, Ukraine, Yugoslavia.

CAMBRO® INTERNATIONAL REPRESENTATIVES

MIDDLE EAST/SOUTH ASIA

Cambro Middle East

Paul Micallief
Tel: 00971 50 45 98 246
Fax: 00971 4 361 94 14
cambromiddleeast@cambro.com
Territories: Armenia, Bahrain, Iraq, Jordan, Kuwait, Lebanon, Oman, Qatar, Saudi Arabia, Syria, United Arab Emirates, Yemen.

Cambro South Asia

Paul Micallief
Tel: 00971 50 4598246
Fax: 00971 4 3619414
cambrosouthasia@cambro.com
Territories: Bangladesh, India, Maldives, Nepal, Pakistan, Sri Lanka

SOUTH AMERICA

Cambro South America

Ken French
Regional Sales Manager
Rio de Janeiro, Brazil
Tel: (55) 21-2705-2262
Fax: (55) 21-2705-2262
kfrench@cambro.com

ARGENTINA

FSG Cambro Argentina

Buenos Aires, Argentina
Estela Costantini
Sales Representative
Tel: (54) 11-4553-7577
Fax: (54) 11-4553-7577
estelac@fsg-hyr.com.ar
www.fsg-hyr.com.ar
Territories: Argentina, Bolivia, Paraguay, Uruguay

FSG Cambro Argentina

Buenos Aires, Argentina
Tel: (54) 11-4553-7577
Fax: (54) 11-4553-7577
info@fsg-hyr.com.ar
www.fsg-hyr.com.ar

BOLIVIA

Cormaq S.A.

Santa Cruz de la Sierra, Bolivia
Tel: (591 3) 349 2828
Fax: (591 3) 348 0802
cormaq@cormarqsa.com
www.cormarqsa.com

BRAZIL

Geode - CM Brazil Comercial Ltda.

São Paulo, Brazil
Tel: (55) 11-3079-2554
Fax: (55) 11-3704-7235
cambro@cmbrasilcomercial.com.br
www.cmbrasilcomercial.com.br

SOUTH AMERICA

BRAZIL

Dayhome Comercial Ltda
São Paulo, SP, Brazil 01132-000
Tel: (55) 11-3337-3335
foodservice@dayhome.com.br

CHILE

Imahe S.A.
Santiago, Chile
Tel: (56-2) 726-0000
Fax: (56-2) 726-0001
imahe@imahe.cl
www.imahe.cl

El Volcán Equip. Gastronómico

Santiago, Chile
Tel: (56) 2-698-93-42
Fax: (56) 2-672-81-72
elvolcan@elvolcan.cl
www.elvolcan.cl

Famadich Ltda.

Santiago, Chile
Tel: (56 2) 484 1400
Fax: (56 2) 484 1445
famadich@famadich.cl
www.famadich.cl

COLOMBIA

Industrial Taylor Ltda.

Bogotá D.C., Columbia
Tel: (571) 357-8400
Fax: (571) 357-8410
equipos@industrialtaylor.com
www.industrialtaylor.com

ECUADOR

Irvi S.A.

Quito, Ecuador
Tel: (5932) 333 2150/2149
Fax: (5932) 333 2064
ventas@irvix.com.ec
www.irvix.com.ec

PARAGUAY

FSG Cambro Paraguay

Asunción, Paraguay
Tel: (54-11) 4776 6002
Fax: (54-11) 4776 7002
estelac@fsg-hyr.com.ar
www.fsg-hyr.com.ar

PERU

OBC SAC

Lima 18, Peru
Tel: (51) 1-719-0380
Fax: (51) 1-242-1578
ventasoccidental@obc-corp.com
www.obc-corp.com.pr

SOUTH AMERICA

PERU

GC Corp
Miraflores, Lima 18, Peru
Tel: (511) 512-2444
Fax: (511) 512-2437
gccorporacion@gc-corporacion.com
www.gc-corporacion.com

URUGUAY

Redplan S.A.

Montevideo, Uruguay
Tel: (598-2) 413-0025
Fax: (598-2) 423-0010
redplan@adinet.com.uy

Santucchi Equip.

Montevideo, Uruguay
Tel: (598-2) 619-3552
Fax: (598-2) 613-2632
ventas@santucchi.com.uy

VENEZUELA

Inversiones Cambroven, C.A.

Caracas, Venezuela
Tel: (58-212) 256 4113 - 257 9687
Fax: (58-212) 258-0506
cambroven@cantv.net

OCEANIA - SOUTH PACIFIC

AUSTRALIA

Comcater - C.C.E. International Pty Ltd.

Derrimut, Victoria 3030, Australia
Tel: (61) 3 8369 4600
Fax: (61) 3 8369 4699
sales@comcater.com.au
www.comcater.com.au

FII

International Hotel Suppliers

Nadi, Fiji
Tel: (679) 6725544
Fax: (679) 6725533
inhotsupp@connect.com.fj

Hotel Equipment Limited

Nadi, Fiji
Tel: (679) 672-0666
Fax: (679) 672-0589
admin@hotelequips.com.fj
salesnadi@hotelequips.com.fj
hotelequip@connect.com.fj

GUAM/SAIPAN

Pacific Sunny International

Saipan CNMI, Guam 96950
Tel: (626) 289-6899
Fax: (626) 289-9123
janetwu@pacsunny.com

Sunny Plastic (Guam) Inc.

DBA Sunny Wholesale
St. Harmon, Guam 69613
Tel: (671) 646-9778
Fax: (671) 646-9768
alma@pacsunny.com

OCEANIA - SOUTH PACIFIC

GUAM/SAIPAN

Pacific Sunny Saipan Inc.

Saipan, MP Guam 96950
Tel: (670) 235 9978
Fax: (670) 235 9768
annpacio@pacsunny.com

Fujimak Guam Corporation

GMF, Guam 96921
Tel: (671) 649-3263
Fax: (671) 649-3265
fujimak@teleguam.net

NEW CALEDONIA

Sicomex NC

Noumea Sud, New Caledonia
Tel: (687) 28-60-80
Fax: (687) 28-60-81
karine@sicomex.nc
rousset@ihug.co.nz

NEW ZEALAND

Burns & Ferrall Limited

Auckland, New Zealand
Tel: (64) 9-633-0900
Fax: (64) 9-636-4434
sales@burnsferrall.co.nz
www.burnsferrall.co.nz

FSG, New Zealand

Auckland, New Zealand
Tel: 64 (0) 27 232 7507
jackw@ihug.co.nz

Newby & Zegelaar Agencies Ltd.

Ponsonby, Auckland, New Zealand
Tel: (64) 9-376-6750
Fax: (64) 9-376-9112
ineke@nzanz.co.nz
www.nzanz.co.nz

Southern Hospitality LTD

New Zealand
13 branches throughout NZ
Tel: (64) 3 4776969
Free Phone: 0800 503-335
Fax: (64) 3 4776383
dmansbridge@southernhospitality.co.nz
www.southernhospitality.co.nz

TAHITI

Sicom

BP 6894-98 702 Faa'a,
Tahiti - Polynesie Française
Tel: (689) 80-34-80
Fax: (689) 80-34-89
sicom.import@sicom.pf
rousset@ihug.co.nz

ALPHA NUMERICAL LISTING WITH LIST PRICES

PRODUCT CODE NUMBER	PAGE NUMBER	LIST PRICE / GROUP 3
1000	14	11.75 15.25
1000CW	35	10.80
1000LCD	131	375.00
1000P	Discontinued 1/1/09	
1000VT	15	10.60
1005CW	35	11.00
1005P	35	8.20
1007CW	35	11.00
1007P	35	8.20
100BC	114	38.00
100BC1	114	42.00
100BCS	114	55.00
100CW	33	2.60
100LCD	131,154	200.00
100MCCW	107	12.70
100MPC	133	365.00
100MPCHL	133	460.00
100TS	34	15.75
100VS	36	11.80
1010VS	36	12.90
1012VS	36	12.90
1013CRVS	36	12.90
1013CW	35	11.05
1013P	35	8.20
1014	13	13.85 17.90
10145CW	27	13.85
10146CW	25,27	12.70
10146DCP	28	8.10
10146DCPC	28	4.75
10146DCW	28	16.30
10146DCWC	28	8.65
1014CL	19	12.60
1014CT	22	21.30
1014FF	21	3.70
1014VS	36	12.90
1015	14	14.3 18.55
1015MT	20,49	14.10
1017	Discontinued 1/1/09	
10302MT	20,49	32.90
1030MT	20,49	22.25
103VS	36	12.20

PRODUCT CODE NUMBER	PAGE NUMBER	LIST PRICE / GROUP 3
105VS	36	12.20
106VS	36	13.65
107VS	36	12.60
10CW	33	3.00
10CWC	97	16.65
10CWCH	97	16.65
10CWCHN	97	16.65
10CWD	95	14.35
10CWGL	97	36.15
10CWL	33	2.30
10CWNR	33	6.40
10HC258	176,181	23.10
10HC414	176	38.35
10HE1	182	12.20
10HE2	182	11.40
10HPC	101	43.75
10HPCH	101	43.75
10HPCHN	101	43.80
10HPD	99	32.25
10HS1114	175	92.45
10HS318	175	34.30
10HS434	175	46.95
10HS638	175	56.70
10HS800	175	68.60
10HS958	175	80.60
10PPCH	105	10.85
10PPD	105	8.35
10PPSC	105	10.85
10SC	97,101	10.80
1100	14	11.75 14.90
1100CT	22	17.30
1101CW	35	11.00
1101P	35	8.20
1111SMVS	36	13.90
1111SQVS	36	13.90
1116	14	15.00 21.00
1120CBP	163	15.20
1120CBR	163	22.55
1121TR	13	18.60 24.35
116VS	36	13.90
1200	14	13.00 17.40

PRODUCT CODE NUMBER	PAGE NUMBER	LIST PRICE / GROUP 3
1200CW	43	2.30
1200DIV	134,141	70.00
1200P	42	1.34
1200P2	42	1.41
1202CW	35	11.05
1202P	Discontinued 1/1/09	
120CWP	33	7.80
120VS	36	17.80
1210PW	134,136,139,141	173.25
1212SQVS	36	18.50
1216	13	16.00 21.00
1216CL	19	14.25
1216CT	22	24.60
1216CW	19	16.65
1216D	15	16.55 21.95
1216FF	21	4.45
12183CW	90	22.30
12183P	91	16.35
12186CW	90	28.25
12186P	91	20.40
12189CW	90	37.95
12189P	91	26.90
1218CCW	90	13.80
1218CP	91	12.55
1218DSCW	91	9.00
1218MT	20,49	17.60
1218SCW	90	29.45
1219D	15	19.45 25.10
1220D	15	21.05 27.00
1222D	15	21.05 26.95
1224MT	20,49	22.05
1227MT	20,49	23.75
1230MT	20,49	25.60
124VS	36	18.50
1252SLB250	78	340.00
1252SLNB250	78	340.00
125MPC	132	275.00
12CW	95	19.75
12HP	99	48.75
12RS12	114	172.00

PRODUCT CODE NUMBER	PAGE NUMBER	LIST PRICE / GROUP 3
12SFSCW	82	24.50
12SFSP	83	15.95
12SFSP	83	16.70
12TGS	56	5.55
1300	14	14.30 18.90
1313	15	14.30 18.75
1318	13	19.85 24.80
1318MT	20,49	18.05
1318MTC	153	455.00
1320TR	13	20.50 26.95
13CLRCW	96	25.15
13CLRHP	100	58.95
1400 (Group 1)	14	14.60 19.75
1400CT (Group 1)	22	23.00
1400CT 376	23	26.25
1400CT 377	23	26.25
1400CT 384	23	26.25
14105CP	27	6.25
14105CW	27	13.90
1411CP	29	5.70
1411CW	29	16.20
1418	13	19.15 24.95
14187TRCP	27	15.10
14187TRCW	27	24.90
1418C	11	19.15
1418CL	19	15.55
1418CT	22	30.65
1418CW	19	23.10
1418D	15	19.25 25.45
1418FF	21	5.65
1418TR	13	18.15 24.50
1418TRCW	19	23.10
1422TR	13	19.85 26.85
14CW	95	25.15
14HP	99	58.95
14PP	105	14.70
150CW	33	4.10
1520	13	23.15 30.00
1520C	11	23.15
1520CBP	163	12.75
1520CBP	163	15.70

ALPHA NUMERICAL LISTING WITH LIST PRICES

PRODUCT CODE NUMBER	PAGE NUMBER	LIST PRICE /GROUP 3
1520CBPF	163	15.70
1520CBR	163	23.10
1520CL	19	17.75
1520CT	22	34.85
1520CW	19	24.05
1520D	15	22.90 28.95
1520TR	13	21.20 27.70
1550	14	18.65 24.30
1550CT	22	31.25
1596CP	26	6.15
1596CW	26	11.15
15CLRCW	96	30.50
15CLRHP	100	76.65
1600	14	18.30 24.50
1600CT	22	30.30
1600CT 376	23	34.60
1600CT 377	23	34.60
1600CT 384	23	34.60
1600CW	43	2.85
1600DIV	110,134,141	70.00
1600P	42	1.58
1600P2	42	1.68
16125	Discontinued 1/1/09	
16126	Discontinued 1/1/09	
1621CBP	163	23.75
1621CBR	163	37.05
1622	13	26.65 34.65
16225	13	29.20 36.45
1622CT	22	43.00
1622D	15	26.25 34.30
16C258	176,181	32.40
16C414	176	45.15
16C578	176	67.45
16CW	95	30.50
16E1	181	14.50
16E2	181	12.85
16E4	182	15.60
16E5	182	13.75
16HP	99	76.65
16PP	105	18.75

PRODUCT CODE NUMBER	PAGE NUMBER	LIST PRICE /GROUP 3
16S1058	173	101.50
16S1114	173	116.40
16S1214	173	117.80
16S318	173	45.55
16S418	173	47.70
16S434	173	59.70
16S534	173	61.10
16S638	173	71.65
16S738	173	73.15
16S800	173	86.50
16S900	173	88.05
16S958	173	99.95
1721	Discontinued 1/1/09	
1722CBCP	163	23.00
1722CBP	163	19.10
1722CBR	163	29.95
17HE1	182	12.70
17HE2	182	12.20
17HS1114	175	99.95
17HS318	175	35.80
17HS434	175	48.90
17HS638	175	61.65
17HS800	175	74.65
17HS958	175	87.50
1800CT	22	43.00
180TS	Discontinued 1/1/09	
1826	13	35.50 45.70
182612CW	90	84.60
182612P	91	56.20
182615CW	90	99.80
182615P	91	66.10
18263CW	90	40.75
18263P	91	27.05
18266CW	90	52.80
18266P	91	35.50
18268CLRCW	91	75.50
18268CLRKIT	91	194.40
18269CW	90	69.45
18269P	91	46.35
1826CCW	90	27.65
1826CL	19	25.55

PRODUCT CODE NUMBER	PAGE NUMBER	LIST PRICE /GROUP 3
1826CLRCW	91	43.65
1826CP	91	20.85
1826CT	22	51.60
1826DBC	152	2,165.00
1826DBCSP	152	2,670.00
1826DSCW	91	22.75
1826DTC	152	2,165.00
1826DTCSP	152	2,690.00
1826LBC	153	1,295.00
1826LBCSP	153	1,510.00
1826LTC	153	1,305.00
1826LTC3	153	1,305.00
1826LTCSP	153	1,535.00
1826MT	20,49,53	28.75
1826MTC	153	680.00
1826SCCW	90	49.50
1826STP	141,153	90.00
18CW	95	36.45
18SFSCW	82	36.35
18SFSP	83	21.55
18SFSP	83	22.75
1950	14	25.25 33.30
1950CT	22	44.00
2000P	42	1.96
2000P2	42	2.13
200BC	114	49.00
200BC1	114	53.00
200BCS	114	66.00
200MCCW	107	17.50
2025	13	43.25 52.70
2025MT	20,49	37.70
2030UT	166	640.00
20C258	176,181	33.60
20C414	176	46.20
20CC	42	2.31
20CFC	103	13.40
20CWC	97	8.70
20CWCH	97	8.70
20CWCHN	97	10.20
20CWWD	95	6.65
20CWGL	97	25.10

PRODUCT CODE NUMBER	PAGE NUMBER	LIST PRICE /GROUP 3
20CWL	97	13.75
20CWLN	97	13.75
20E2	181	11.95
20HPC	101	19.05
20HPCH	101	20.20
20HPCHN	101	23.15
20HPD	99	14.45
20HPL	101	33.49
20HPLN	101	33.49
20LPCWC	97	12.80
20LPCWD	95	7.45
20LPHPC	101	26.10
20LPHPD	99	16.10
20PPCH	105	7.45
20PPD	105	4.30
20PPSC	105	6.65
20SC	97,101	6.25
21155CBP	163	17.70
21155CBR	163	27.05
21157CBP	163	19.10
21157CBR	163	31.20
2115CBCP	163	12.70
2115CBCR	163	13.20
22CW	95	10.95
22HP	99	24.30
22LPCW	95	15.00
22LPHP	99	34.65
22SFSCW	82	46.05
22SFSP	83	26.35
22SFSP	83	28.00
2359	Discontinued 1/1/09	
23CLRCW	96	13.65
23CLRHP	100	31.60
23SL	78	370.00
23SLB250	78	685.00
23SLB6250	78	178.00
23SLINB250	78	685.00
240MPC	132	255.00
2436UTH	166	600.00
2436UTHS	166	640.00
24CW	95	13.65

ALPHA NUMERICAL LISTING WITH LIST PRICES

PRODUCT CODE NUMBER	PAGE NUMBER	LIST PRICE /GROUP 3
24HP	99	31.60
24LPCW	95	18.70
24LPHP	99	43.10
24PP	105	8.75
2500	14	34.60 45.70
2500CT	22	54.75
250LCD	131	215.00
25CLRCW	96	17.55
25CLRHP	100	40.50
25E1	181	15.30
25E2	181	13.30
25E4	182	17.80
25E5	182	14.95
25MCCW	107	6.05
25S1058	174	108.90
25S1114	174	116.40
25S1214	174	125.30
25S318	174	45.55
25S418	174	49.25
25S434	174	60.45
25S534	174	63.40
25S638	174	72.35
25S738	174	78.25
25S800	174	86.50
25S900	174	94.00
25S958	174	99.95
2632	15	13.55 17.50
26CF	103	55.60
26CW	95	17.55
26HP	99	40.50
26PP	105	11.40
2700	14	40.30 53.35
2700CT	22	61.60
28CW	95	22.30
2900CT	22	69.90
2SFSCW	82	7.90
2SFSP	83	5.55
2SFSP	83	5.90
300DIV	134,136,141	70.00
300MPC	136	445.00

PRODUCT CODE NUMBER	PAGE NUMBER	LIST PRICE /GROUP 3
3046	15	17.00 22.55
30CFC	103	11.15
30CWC	97	6.40
30CWCH	97	6.40
30CWCHN	97	8.70
30CWD	95	6.15
30CWGL	97	17.30
30CWL	97	11.75
30CWLN	97	11.75
30HPC	101	14.20
30HPCH	101	16.05
30HPCHN	101	16.05
30HPD	99	10.85
30HPL	101	23.94
30HPLN	101	23.94
30PPCH	105	5.15
30PPCHN	105	6.35
30PPD	105	4.00
30PPSC	105	5.90
30SC	97,101	4.60
3200P2	42	3.17
320TS		Discontinued 1/1/09
3242	15	16.40 18.90
3253	15	20.20 27.00
3253CL	19	15.30
3253CT	22	35.85
32CC	42	3.47
32CW	95	8.25
32HP	99	20.35
3343	15	17.05 22.70
33CLRCW	96	11.35
33CLRHP	100	26.35
34CW	95	11.35
34HP	99	26.35
34PP	105	7.25
350LCD	131	210.00
3555TR		Discontinued 1/1/09
35CLRCW	96	13.25
35CLRHP	100	35.80
35CW	33	2.10
36CF	103	41.80

PRODUCT CODE NUMBER	PAGE NUMBER	LIST PRICE /GROUP 3
36CW	95	13.25
36E1	181	15.60
36E2	181	14.05
36E4	182	20.15
36E5	182	15.60
36HP	99	35.80
36PP	105	8.40
36S1058	174	112.65
36S1114	174	116.40
36S1214	174	127.60
36S318	174	47.70
36S418	174	51.45
36S434	174	61.10
36S534	174	66.35
36S638	174	73.75
36S738	174	82.00
36S800	174	88.05
36S900	174	97.75
36S958	174	102.95
3753	15	23.00 30.05
3753CL	19	17.25
3850		Discontinued 1/1/09
3853	15	22.80 30.05
38CW	95	16.95
3949		Discontinued 1/1/09
400DIV	134,136,139,141	70.00
400MCCW	107	19.00
400STP	136,139,144,166	15.00
4050		Discontinued 1/1/09
40CWC	97	5.80
40CWCH	97	5.80
40CWCHN	97	5.80
40CWD	95	5.15
40HPC	101	11.55
40HPCH	101	12.40
40HPCHN	101	12.60
40HPD	99	10.85
40PPCH	105	5.05
40PPD	105	3.35

PRODUCT CODE NUMBER	PAGE NUMBER	LIST PRICE /GROUP 3
40PPSC	105	4.75
40SC	97,101	4.15
415CBP	163	7.00
415CBR	163	9.15
42CW	95	8.35
42HP	99	17.60
44CW	95	9.80
44HP	99	21.75
44PP	105	6.25
45CW	33	2.55
46	13	4.40 6.15
46CW	95	11.35
46HP	99	27.85
46PP	105	7.25
480TS		Discontinued 1/1/09
49E1	181	15.60
49E2	181	14.05
49S1114	174	120.85
49S318	174	48.45
49S434	174	62.60
49S638	174	75.40
49S800	174	88.05
49S958	174	104.45
4FBR	118	1,670.00
4FBRS	118	1,665.00
4FBRTT	118	1,115.00
4SFSCW	82	12.10
4SFSP	83	7.60
4SFSP	83	8.05
4UBR	118	1,855.00
500CW	43	1.45
500LCD	131	245.00
500P	42	0.86
500P2	42	0.92
50CW	33	3.00
50MCCW	107	11.30
5412CBP	114,154	8.40
55CWNR	33	2.55
57	13	4.75 6.70
5F		Discontinued 1/1/09
5FBR	118	1,770.00

ALPHA NUMERICAL LISTING WITH LIST PRICES

PRODUCT CODE NUMBER	PAGE NUMBER	LIST PRICE / GROUP 3
5FBRSL	118	1,765.00
5FBRTT	118	1,225.00
5UBR	118	1,960.00
60CFC	103	6.00
60CW	33	3.00
60CWC	97	4.55
60CWCH	97	5.00
60CWCHN	97	5.00
60CWD	95	2.75
60CWGL	97	14.20
60CWL	97	6.65
60CWLN	97	6.65
60HPC	101	10.05
60HPCH	101	10.05
60HPCHN	101	10.05
60HPD	99	5.60
60HPL	101	13.70
60HPLN	101	13.70
60PPCH	105	4.35
60PPCHN	105	4.75
60PPD	105	2.25
60PPSC	105	4.35
60SC	97,101	3.15
62CW	95	6.05
62HP	99	13.75
6302MT	20,49	27.95
630MT	20,49	17.80
63CLRCW	96	6.85
63CLRHP	100	16.60
640TS	Discontinued 1/1/09	
64CW	95	6.85
64HP	99	16.60
64PP	105	4.70
650BIBR	121	165.00
650WS	121	66.00
65CLRCW	96	9.15
65CLRHP	100	20.15
65CWNR	33	3.00
66CF	103	28.45
66CW	95	9.15
66HP	99	20.15

PRODUCT CODE NUMBER	PAGE NUMBER	LIST PRICE / GROUP 3
66PP	105	6.15
68VS	36	9.80
6F	52	10.60
6FBR	118	1,825.00
6FBRSL	118	1,825.00
6FBRTT	118	1,330.00
6RS6	114	125.00
6SFSCW	82	15.65
6SFSP	83	9.40
6SFSP	83	10.00
6TGS	56	2.35
6UBR	118	2,110.00
725CWNR	33	4.10
730BIBR	121	330.00
730SR	121	105.00
730STP	113	26.00
730WS	121	46.00
75CW	33	3.95
800CW	43	1.75
800P	42	1.03
800P2	42	1.12
806CW	35	9.05
810	13	10.50 13.60
825CWNR	33	4.80
8262MT	20,49	22.90
826MT	20,49	14.60
8302MT	20,49	30.75
830MT	20,49	20.15
850CW	43	4.50
853FCP	29	5.10
853FCPC	29	2.70
853FCW	29	10.50
853FCWC	29	5.55
853FH	29	17.45
853FHC	29	10.05
85SFVS	36	11.60
86VS	36	10.85
8F	52	12.30
8FB434	178	38.05
8FBNH434	178	22.40
8HC258	176,181	23.10

PRODUCT CODE NUMBER	PAGE NUMBER	LIST PRICE / GROUP 3
8HC414	176	38.35
8HE1	182	12.20
8HE2	182	10.90
8HS1114	175	92.45
8HS318	175	34.30
8HS434	175	46.95
8HS638	175	56.70
8HS800	175	68.60
8HS958	175	80.60
8RS8	114	139.00
8SFSCW	82	18.40
8SFSP	83	11.20
8SFSP	83	11.85
900	14	10.65 13.50
900CT	22	17.30
900CW	35	9.10
900P	42	1.74
900P2	42	1.90
9011CW	35	10.85
9011P	Discontinued 1/1/09	
9013CW	35	10.85
9013P	Discontinued 1/1/09	
901CW	35	9.70
901P	35	6.90
905CW	35	10.00
909CW	35	9.95
909P	Discontinued 1/1/09	
90CWC	97	5.10
90CWCN	97	5.10
90CWD	95	2.10
90HPC	101	6.90
90HPD	99	4.15
90PPC	105	3.75
90PPD	105	1.55
90PPSC	105	3.75
90SC	97,101	2.80
90SPCW	33	6.80
9113CP	28	6.40
9113CW	28	14.85
9114CP	28	6.40
9114CW	28	15.50

PRODUCT CODE NUMBER	PAGE NUMBER	LIST PRICE / GROUP 3
911CPC	28	3.50
911CWC	28	10.50
911VS	36	11.95
912CBP	163	9.50
912CBR	163	13.15
913VS	36	11.60
915	13	14.95 17.30
915CP	26	6.15
915CW	26	11.15
918MT	20,49	16.90
91VS	36	11.60
926	13	19.55 25.25
92615MT	20,49	18.75
926MT	20,49	18.80
92CW	95	6.15
92HP	99	10.40
93CW	33	6.75
94CW	95	7.50
94HP	99	12.15
94PP	105	5.25
950CW	43	2.05
950P	42	1.20
950P2	42	1.31
95VS	36	11.60
96CW	33	3.95
96SKRC	57	5.40
96SKRD	57	5.40
96SKRF	57	5.40
96SKRLC	57	0.95
96SKRLD	57	0.95
96SKRLF	57	0.95
96SKRLM	57	0.95
96SKRLN	57	0.95
96SKRLP	57	0.95
96SKRML	57	5.40
96SKRNL	57	5.40
96SKRPP	57	5.40
978SFVS	36	11.80
99SMVS	36	11.60
99VS	36	11.60
9CWNR	33	4.65

ALPHA NUMERICAL LISTING WITH LIST PRICES

PRODUCT CODE NUMBER	PAGE NUMBER	LIST PRICE /GROUP 3
9E1	181	13.70
9E2	181	12.85
9RS9	114	152.00
9S1114	173	116.40
9S318	173	45.55
9S434	173	59.40
9S638	173	70.90
9S800	173	86.20
9S958	173	99.95
9TGS	56	3.65
A4SLL21	78	175.00
ADCS	169	1,155.00
BAR540	125	2,250.00
BAR540DS	125	2,900.00
BAR54SR	121	72.00
BAR650	125	4,480.00
BAR650CP	125	6,750.00
BAR650DS	125	6,155.00
BAR650DSCP	125	8,800.00
BAR650SDX	124	10,175.00
BAR650SPM	124	13,970.00
BAR650SPMT	124	15,785.00
BAR650SPMT2	124	15,895.00
BAR650DX	124	8,370.00
BAR650PM	124	12,635.00
BAR650PMT	124	13,880.00
BAR650PMT220	124	14,300.00
BAR730	123	5,240.00
BAR730CP	123	7,645.00
BAR730DS	123	7,180.00
BAR730DSCP	123	10,945.00
BAR730SDX	122	12,045.00
BAR730SPM	122	15,345.00
BAR730SPMT	122	17,325.00
BAR730SPMT2	122	17,435.00
BAR730DX	122	8,910.00
BAR730PM	122	13,555.00
BAR730PMT	122	14,850.00
BAR730PMT220	122	14,960.00
BBR480	118	705.00
BBR720	118	840.00

PRODUCT CODE NUMBER	PAGE NUMBER	LIST PRICE /GROUP 3
BC1115SH	162	70.00
BC11TC	162	75.00
BC225	162	510.00
BC2254S	162	525.00
BC230	162	645.00
BC2304S	162	655.00
BC235	162	700.00
BC2354S	162	710.00
BC330	162	695.00
BC3304S	162	705.00
BC331KD	161	196.00
BC331KDOSH	161	46.00
BC331KDTC	161	80.00
BC340KD	161	292.00
BC340KDP	161	80.00
BCT1014	25	9.30
BR258	177,181	29.75
BR414	177	43.30
BR578	177	55.55
BR712	177	68.15
BSB10	52	11.05
BSB12	52	14.25
BSB18	52	30.05
BUF48	118	375.00
BUF72	118	435.00
BV6CW	45	3.25
BWB16CW	38	10.70
BWM10CW	38	10.30
BWP14CW	38	11.15
BWW10CW	38	8.10
CB1220	110,111,113,150	42.00
CC32	106	520.00
CCP12	54	8.45
CCP15	54	13.25
CCP27	54	14.10
CCPL12	54	1.25
CCPL27	54	1.30
CD100	165	280.00
CD100H	165	450.00
CD100HB	165	545.00

PRODUCT CODE NUMBER	PAGE NUMBER	LIST PRICE /GROUP 3
CD1313	164	235.00
CD1327	164	250.00
CD1420	164	250.00
CD160	165	280.00
CD1826H	164	470.00
CD1826HB	164	590.00
CD1826MTC	153,166	510.00
CD1826MTCBH	153	645.00
CD1826PDB	166	315.00
CD2020	164	255.00
CD2020H	164	410.00
CD2020HB	164	535.00
CD2028	164	265.00
CD300	136,165	280.00
CD300H	165	445.00
CD300HB	165	535.00
CD400	136,139,144,165	310.00
CDR2020	164,180	160.00
CDR2020H	164,180	260.00
CFPFC10	103	35.70
CFPMRC10	103	36.05
CFPSRC10	103	15.15
CFR18	103	30.85
CFRC18	103	17.20
CFRSC18	103	5.10
CJ80CW	57	7.65
CLS89190	34	78.00
CLSM8B5190	34	93.00
CLSSM8B5148	34	78.00
CMB1826	151	4,790.00
CMB1826L	151	2,920.00
CMB1826LSP	151	3,195.00
CMB1826SP	151	5,345.00
CMBH1826LC	150	5,520.00
CMBH1826LF	150	5,520.00
CMBH1826LTR	150	5,805.00
CMBH1826TBC	150	8,840.00
CMBH1826TBF	150	8,840.00
CMBH1826TSC	150	8,840.00
CMBH1826TSF	150	8,840.00

PRODUCT CODE NUMBER	PAGE NUMBER	LIST PRICE /GROUP 3
CMBH1826TTR	150	9,350.00
CMBHC1826LC	150	10,050.00
CMBHC1826LF	150	10,050.00
CMBHC1826LTR	150	10,340.00
CMBHC1826TBC	150	14,115.00
CMBHC1826TBF	150	14,115.00
CMBHC1826TSC	150	14,115.00
CMBHC1826TSF	150	14,115.00
CMBHC1826TTR	150	14,610.00
CMBR	150	55.00
CP12	54	7.40
CP1210	110,113,134	64.00
CP1220	110,113,134,136,139	125.00
CP15	54	9.20
CP27	54	10.50
CPC13134	Discontinued	1/1/09
CPC13134A	Discontinued	1/1/09
CPH3	118	60.00
CPL12	54	1.30
CPL27	54	1.35
CR12	167	270.00
CRP12910	179	130.75
CRP12911	179	167.05
CRP141012	179	181.55
CRP181112	179	188.85
CRP191011	179	167.05
CRP2046	179	127.90
CRP20910	179	148.10
CRP2878	179	127.90
CRP3067	179	127.90
CRP4467	179	138.00
CRP4856	179	127.90
CRP6345	179	127.90
CRP9911	179	167.05
CRPG12910	182	20.35
CRPG12911	182	24.65
CRPG141012	182	25.50
CRPG181112	182	28.70
CRPG191011	182	26.85

ALPHA NUMERICAL LISTING WITH LIST PRICES

PRODUCT CODE NUMBER	PAGE NUMBER	LIST PRICE /GROUP 3
CRPG2046	182	35.05
CRPG20910	182	28.35
CRPG2878	182	24.35
CRPG3067	182	29.70
CRPG4467	182	34.30
CRPG4856	182	35.05
CRPG6345	182	35.05
CRPG9911	182	24.65
CRPH1656	179	101.70
CRPHDG2878	177	25.85
CRPHDG2878	182	25.85
CRPHG1656	182	28.05
CS1424SK	67	56.70
CS1424VK	67	55.30
CS1430SK	67	70.40
CS1430VK	67	68.80
CS1436SK	67	78.25
CS1436VK	67	76.20
CS1442SK	67	90.10
CS1442VK	67	87.25
CS1448SK	67	99.35
CS1448VK	67	96.65
CS1454SK	67	111.10
CS1454VK	67	107.55
CS1460SK	67	119.85
CS1460VK	67	115.35
CS1472SK	67	140.60
CS1472VK	67	135.50
CS1824SK	67	59.50
CS1824VK	67	56.75
CS1830SK	67	73.20
CS1830VK	67	70.20
CS1836SK	67	81.45
CS1836VK	67	77.75
CS1842SK	67	97.45
CS1842VK	67	92.80
CS1848SK	67	102.70
CS1848VK	67	98.25
CS1854SK	67	118.80
CS1854VK	67	113.20
CS1860SK	67	130.10

PRODUCT CODE NUMBER	PAGE NUMBER	LIST PRICE /GROUP 3
CS1860VK	67	123.50
CS1872SK	67	151.00
CS1872VK	67	143.55
CS2124SK	67	66.20
CS2124VK	67	63.60
CS2130SK	67	82.85
CS2130VK	67	78.80
CS2136SK	67	92.60
CS2136VK	67	87.85
CS2142SK	67	110.00
CS2142VK	67	104.95
CS2148SK	67	118.40
CS2148VK	67	111.40
CS2154SK	67	135.75
CS2154VK	67	128.50
CS2160SK	67	147.80
CS2160VK	67	140.20
CS2172SK	67	173.20
CS2172VK	67	163.50
CS2424SK	67	70.45
CS2424VK	67	65.05
CS2430SK	67	87.00
CS2430VK	67	81.00
CS2436SK	67	97.70
CS2436VK	67	91.10
CS2442SK	67	113.15
CS2442VK	67	106.35
CS2448SK	67	123.95
CS2448VK	67	116.40
CS2454SK	67	139.55
CS2454VK	67	130.65
CS2460SK	67	151.30
CS2460VK	67	141.20
CS2472SK	67	177.40
CS2472VK	67	166.25
CSA41366	69	447.75
CSA41367	69	449.75
CSA41426	69	516.20
CSA41427	69	518.15
CSA41486	69	541.90
CSA41487	69	543.90

PRODUCT CODE NUMBER	PAGE NUMBER	LIST PRICE /GROUP 3
CSA41546	69	610.35
CSA41547	69	612.30
CSA41606	69	657.20
CSA41607	69	659.20
CSA44366	70	461.45
CSA44367	70	463.60
CSA44426	70	522.60
CSA44427	70	524.75
CSA44486	70	562.65
CSA44487	70	564.80
CSA44546	70	619.65
CSA44547	70	621.80
CSA44606	70	661.85
CSA44607	70	664.00
CSA48366	68	405.10
CSA48367	68	407.15
CSA48426	68	465.15
CSA48427	68	467.25
CSA48486	68	486.90
CSA48487	68	489.00
CSA48546	68	546.75
CSA48547	68	548.85
CSA48606	68	587.90
CSA48607	68	590.00
CSA51366	69	535.60
CSA51367	69	537.55
CSA51426	69	621.10
CSA51427	69	623.10
CSA51486	69	653.30
CSA51487	69	655.25
CSA51546	69	738.80
CSA51547	69	740.80
CSA51606	69	797.40
CSA51607	69	799.35
CSA54366	70	552.55
CSA54367	70	554.70
CSA54368PKG480		
	71	569.60
CSA54426	70	629.00
CSA54427	70	631.15
CSA54428PKG480		

PRODUCT CODE NUMBER	PAGE NUMBER	LIST PRICE /GROUP 3
	71	646.05
CSA54486	70	679.05
CSA54487	70	681.20
CSA54488PKG480		
	71	696.10
CSA54546	70	750.25
CSA54547	70	752.40
CSA54548PKG480		
	71	767.30
CSA54606	70	803.05
CSA54607	70	805.20
CSA54608PKG480		
	71	820.10
CSA58366	68	482.85
CSA58367	68	484.95
CSA58426	68	557.90
CSA58427	68	560.00
CSA58486	68	585.15
CSA58487	68	587.25
CSA58546	68	659.95
CSA58547	68	662.05
CSA58606	68	711.35
CSA58607	68	713.45
CSCC	66	5.40
CSCR	72	40.25
CSCS	72	40.25
CSCSL	72	83.65
CSCTL	72	83.65
CSDC	75	136.00
CSDDCPKG480	75	2,100.00
CSDS14	66	60.05
CSDS18	66	62.00
CSDS21	66	63.60
CSDS24	66	65.20
CSEQ3	66	33.00
CSFE14	74	18.10
CSFE18	74	19.60
CSFE21	74	20.70
CSFE24	74	21.85
CSFT241	74	18.15
CSFT242	74	23.95
CSFT301	74	19.35

ALPHA NUMERICAL LISTING WITH LIST PRICES

PRODUCT CODE NUMBER	PAGE NUMBER	LIST PRICE /GROUP 3
CSFT302	74	26.35
CSFT361	74	20.55
CSFT362	74	28.75
CSFT421	74	21.85
CSFT422	74	32.05
CSFT481	74	23.70
CSFT482	74	34.55
CSFT541	74	25.60
CSFT542	74	37.80
CSFT601	74	26.80
CSFT602	74	40.20
CSFT721	74	29.90
CSFT722	74	45.95
CSHDDDB	64	10.70
CSHDTK10	64	620.00
CSHDTK12	64	715.00
CSHDTK145	64	805.00
CSID	66	2.25
CSID3	66	2.25
CSPK1432	66	60.25
CSPK1456	66	82.30
CSPK1464	66	89.80
CSPK1472	66	91.90
CSPK1484	66	106.75
CSPK1832	66	64.45
CSPK1856	66	86.50
CSPK1864	66	94.00
CSPK1872	66	96.10
CSPK1884	66	111.05
CSPK2132	66	66.85
CSPK2156	66	88.95
CSPK2164	66	96.40
CSPK2172	66	98.40
CSPK2184	66	113.30
CSPK2432	66	67.65
CSPK2456	66	89.70
CSPK2464	66	97.15
CSPK2472	66	99.30
CSPK2484	66	114.20
CSPRK1835	72	66.65
CSPRK1859	72	89.95

PRODUCT CODE NUMBER	PAGE NUMBER	LIST PRICE /GROUP 3
CSPRK1867	72	97.75
CSPRK1875	72	99.85
CSPRK2135	72	68.95
CSPRK2159	72	92.30
CSPRK2167	72	100.10
CSPRK2175	72	102.20
CSPRK2435	72	69.80
CSPRK2459	72	93.10
CSPRK2467	72	100.80
CSPRK2475	72	103.00
CSR3	129	435.00
CSR5	129	450.00
CSRDB	72	9.30
CSSB	72	45.40
CSSC2448	75	640.00
CSU41366	69	544.15
CSU41367	69	548.15
CSU41426	69	612.60
CSU41427	69	616.55
CSU41486	69	638.35
CSU41487	69	642.30
CSU41546	69	706.75
CSU41547	69	710.70
CSU41606	69	753.60
CSU41607	69	757.55
CSU44366	70	558.60
CSU44367	70	562.85
CSU44426	70	619.75
CSU44427	70	624.05
CSU44486	70	659.80
CSU44487	70	664.05
CSU44546	70	716.75
CSU44547	70	721.05
CSU44606	70	759.00
CSU44607	70	763.30
CSU48366	68	499.05
CSU48367	68	503.25
CSU48426	68	559.15
CSU48427	68	563.30
CSU48486	68	580.90
CSU48487	68	585.10

PRODUCT CODE NUMBER	PAGE NUMBER	LIST PRICE /GROUP 3
CSU48546	68	640.75
CSU48547	68	644.95
CSU48606	68	681.90
CSU48607	68	686.05
CSU51366	69	632.00
CSU51367	69	635.95
CSU51426	69	717.55
CSU51427	69	721.50
CSU51486	69	749.70
CSU51487	69	753.65
CSU51546	69	835.25
CSU51547	69	839.20
CSU51606	69	893.80
CSU51607	69	896.65
CSU54366	70	649.65
CSU54367	70	653.95
CSU54368PKG480	71	683.75
CSU54426	70	726.10
CSU54427	70	730.40
CSU54428PKG480	71	760.20
CSU54486	70	776.15
CSU54487	70	780.45
CSU54488PKG480	71	810.25
CSU54546	70	847.40
CSU54547	70	851.70
CSU54548PKG480	71	881.50
CSU54606	70	900.20
CSU54607	70	904.50
CSU54608PKG480	71	934.30
CSU58366	68	576.85
CSU58367	68	581.00
CSU58426	68	651.90
CSU58427	68	656.10
CSU58486	68	679.15
CSU58487	68	683.30
CSU58546	68	753.95
CSU58547	68	758.10

PRODUCT CODE NUMBER	PAGE NUMBER	LIST PRICE /GROUP 3
CSU58606	68	805.35
CSU58607	68	809.55
CSUHD44367	64	951.20
CSUHD44427	64	1,016.40
CSUHD44486	64	1,054.60
CSUHD44487	64	1,059.40
CSUR41366	73	903.15
CSUR41367	73	907.55
CSUR41426	73	971.15
CSUR41427	73	975.50
CSUR41486	73	997.15
CSUR41487	73	1,001.60
CSUR44366	74	917.75
CSUR44367	74	922.00
CSUR44426	74	978.55
CSUR44427	74	983.00
CSUR44486	74	1,018.65
CSUR44487	74	1,023.15
CSUR48366	73	858.10
CSUR48367	73	862.40
CSUR48426	73	918.10
CSUR48427	73	922.50
CSUR48486	73	939.85
CSUR48487	73	944.25
CSUR51366	73	991.05
CSUR51367	73	995.45
CSUR51426	73	1,076.00
CSUR51427	73	1,080.40
CSUR51486	73	1,108.60
CSUR51487	73	1,113.05
CSUR54366	74	1,008.75
CSUR54367	74	1,013.10
CSUR54426	74	1,085.00
CSUR54427	74	1,089.30
CSUR54486	74	1,135.15
CSUR54487	74	1,139.50
CSUR58366	73	935.85
CSUR58367	73	940.15
CSUR58426	73	1,010.90
CSUR58427	73	1,015.25
CSUR58486	73	1,038.00

ALPHA NUMERICAL LISTING WITH LIST PRICES

PRODUCT CODE NUMBER	PAGE NUMBER	LIST PRICE / GROUP 3
CSURS58487	73	1,042.45
CSURS41366	73	723.00
CSURS41367	73	727.45
CSURS41426	73	790.90
CSURS41427	73	795.35
CSURS41486	73	817.10
CSURS41487	73	821.35
CSURS44366	74	737.55
CSURS44367	74	741.90
CSURS44426	74	798.40
CSURS44427	74	802.80
CSURS44486	74	838.65
CSURS44487	74	842.90
CSURS48366	73	677.90
CSURS48367	73	682.35
CSURS48426	73	737.90
CSURS48427	73	742.35
CSURS48486	73	759.65
CSURS48487	73	764.05
CSURS51366	73	810.90
CSURS51367	73	815.30
CSURS51426	73	895.85
CSURS51427	73	900.20
CSURS51486	73	928.45
CSURS51487	73	932.80
CSURS54366	74	828.60
CSURS54367	74	833.05
CSURS54426	74	904.75
CSURS54427	74	909.20
CSURS54486	74	954.90
CSURS54487	74	959.35
CSURS58366	73	755.65
CSURS58367	73	760.05
CSURS58426	73	830.65
CSURS58427	73	835.10
CSURS58486	73	857.80
CSURS58487	73	862.25
CSWF	66	25.00
CSWS1436SK	76	130.00
CSWS1436VK	76	130.00
CSWS1448SK	76	150.00

PRODUCT CODE NUMBER	PAGE NUMBER	LIST PRICE / GROUP 3
CSWS1448VK	76	150.00
CSWS1836SK	76	150.00
CSWS1848SK	76	165.00
CSWS36EK	76	205.00
CSWS48EK	76	305.00
CVC55	112	3,210.00
CVC72	112	5,350.00
CVC724	112	5,350.00
D12	41	1.32
D14	41	1.62
D16	41	1.67
D24	41	2.16
D8	41	1.25
DB18263CW	77	45.60
DB18263P	77	42.25
DB18266CW	77	61.30
DBC1826CW	77	33.25
DBC1826P	77	28.00
DC10	47	13.45
DC1125	170	975.00
DC1225	170	990.00
DC5	47	9.75
DC575	170	925.00
DC700	170	925.00
DC825	170	925.00
DC950	170	935.00
DCC10	47	9.50
DCC5	47	6.85
DD1220BECW	53	74.45
DD1220CW	53	48.35
DD1220ECW	53	61.10
DD1220SCW	53	61.10
DD1826CW	53	67.85
DIV12	113,118	3.70
DIV20	118,133	8.85
DP15	47	11.90
DRC2020	180	50.50
DRLNK	77	2.40
DRS30	77	195.00
DRS300	77	195.00
DRS36	77	210.00

PRODUCT CODE NUMBER	PAGE NUMBER	LIST PRICE / GROUP 3
DRS360	77	210.00
DRS48	77	255.00
DRS480	77	255.00
DRS60	77	290.00
DRS600	77	290.00
DSPR6	44	40.60
DT1220CW	53	19.50
E3	182	10.95
ES28	111	1,155.00
ES28L	111	1,350.00
ES28LS	111	1,350.00
ES28R	111	1,350.00
ES28RL	111	1,540.00
ES28RLS	111	1,540.00
ES28RS	111	1,360.00
FBR4R	118	335.00
FBR5R	118	340.00
FBR6R	118	355.00
FBRTBL	118	360.00
FR258	178	32.05
FSG480	118	335.00
FSG720	118	425.00
FWC56	167,178	4.00
GB1200CW	38	4.55
GB850CW	38	3.85
GK2000	176	16.45
HBR258	177,181	20.15
HBR414	177	32.45
HBR578	177	41.80
HBR712	177	51.45
HE3	182	9.75
HFR258	178	27.60
HK39	33	26.90
HK93BCW	33	14.55
HK93CW	33	26.80
HK93PMC	Discontinued 1/1/09	
HT10CW	40	2.60
HT120CW	40	2.72
HT12CW	40	2.67
HT14CW	40	2.99
HT16CW	40	3.48

PRODUCT CODE NUMBER	PAGE NUMBER	LIST PRICE / GROUP 3
HT22CW	40	4.35
HT5CW	40	2.39
HT8CW	40	2.50
HWAPR	129	240.00
HWATD	129	315.00
IB32	106	350.00
IB36	106	360.00
IB44	106	365.00
IBS20	106	330.00
IBS27	106	340.00
IBS37	106	360.00
IBSF27	106	355.00
ICS100L	126	875.00
ICS100L4S	126	900.00
ICS125L	126	895.00
ICS125LB	126	965.00
ICS125T	126	955.00
ICS175L	126	1,070.00
ICS175LB	126	1,110.00
ICS175T	126	1,120.00
ICS175TB	126	1,195.00
ICS200TB	126	1,225.00
KK1200	176	15.50
KMC24	110	655.00
KSC402	111	4,745.00
KSC402220	111	4,745.00
KVC854	110	6,545.00
KVC854C	110	9,065.00
KVC854U	110	6,995.00
KVC856	110	6,545.00
KVC856C	110	9,065.00
KVC856U	110	6,995.00
KWS40	111	2,280.00
LCDC	131	80.00
LCDC10	131	120.00
LCDES	129,131	17.05
LD105	54	3.15
LD105A	54	4.50
LD130	54	3.50
LD130A	54	4.75
LD85	54	3.15

ALPHA NUMERICAL LISTING WITH LIST PRICES

PRODUCT CODE NUMBER	PAGE NUMBER	LIST PRICE / GROUP 3
LD85A	54	4.50
LT10	41	1.84
LT12	41	2.01
LT14	41	2.13
LT16	41	2.35
LT22	41	2.65
LT6	41	1.62
LT8	41	1.77
MDC1411T60	158	5,275.00
MDC1418S20	156	2,950.00
MDC1418T16	157	2,985.00
MDC1418T30	157	5,275.00
MDC1520S20	156	3,015.00
MDC1520T16	157	3,065.00
MDC1520T30	157	5,330.00
MDC24	154	2,200.00
MDC24F	154	2,200.00
MDC24R	154	140.00
MDSB5	34	2.85
MDSB9	34	2.85
MDS9	34	17.65
MDSL9	34	8.00
MDSM8	34	2.85
MDSP9	34	41.30
MDSPL	34	78.00
NT10	40	1.60
NT12	40	1.66
NT14	40	1.93
NT16	40	1.98
NT20	40	2.45
NT5	40	1.30
NT8	40	1.34
NT9	40	1.47
OETR314	178	31.35
P320CW	37	9.90
P480CW	37	11.95
P600CW	37	12.65
P60CW	37	14.60
P64CW	37	14.60
PC64CW	37	18.75
PL60CW	37	8.65

PRODUCT CODE NUMBER	PAGE NUMBER	LIST PRICE / GROUP 3
PPB15	45	68.90
PPB18	45	90.90
PPB23	45	156.35
PR314	178	32.05
PR500	178	45.55
PR59314	178	32.05
PR59500	178	45.55
PS1014	25	5.80
PSB10	50	11.05
PSB12	50	14.30
PSB15	51	23.30
PSB18	51	37.10
PSB23	51	56.50
PSB6	50	3.30
PSB8	50	5.60
PT1014	24	11.95
PT1100	24	9.35
PT1216	24	13.05
PT1400	24	12.50
PT1418	24	16.55
PT1600	24	16.85
PWB22	44,129	23.30
R1000LCD	131	95.00
R500LCD	129,131	85.00
RD1200CW	53	27.75
RD1220CW	53	51.15
RD1220CWH	53	72.80
RD1826CW	53	66.30
RD1826CWH	53	77.40
RD926CW	53	45.05
RFS1	87	3.60
RFS12	87	13.10
RFS12PP	87	13.90
RFS12SCPP	86	6.15
RFS18	87	15.90
RFS18PP	87	16.90
RFS1PP	87	3.75
RFS1SCPP	86	1.80
RFS2	87	3.90
RFS22	87	18.70
RFS22PP	87	19.85

PRODUCT CODE NUMBER	PAGE NUMBER	LIST PRICE / GROUP 3
RFS2PP	87	4.15
RFS2SCPP	86	2.75
RFS4	87	4.50
RFS4PP	87	4.90
RFS6	87	5.55
RFS6PP	87	5.90
RFS6SCPP	86	2.85
RFS8	87	7.30
RFS8PP	87	7.85
RFSC1	87	1.30
RFSC12	44	4.55
RFSC12	87	4.55
RFSC12PP	87	4.80
RFSC1PP	87	1.40
RFSC2	87	1.35
RFSC2PP	87	1.45
RFSC6	87	1.90
RFSC6PP	87	2.10
RFSCW1	86	6.15
RFSCW12	86	30.15
RFSCW18	86	41.35
RFSCW2	86	8.50
RFSCW22	86	47.60
RFSCW4	86	14.40
RFSCW6	86	16.85
RFSCW8	86	21.35
RFSCWC1	86	2.20
RFSCWC12	86	11.55
RFSCWC2	86	4.00
RFSCWC6	86	5.05
RSB1014CW	51	17.15
RSB10CW	51	15.00
RSB12CW	51	25.00
RSB1419CW	51	27.80
RSB15CW	51	32.30
RSB18CW	51	46.55
RSB23CW	51	70.10
RSB6CW	51	4.20
RSB8CW	51	8.20
RSB912CW	51	11.70
SB55	52	1.65

PRODUCT CODE NUMBER	PAGE NUMBER	LIST PRICE / GROUP 3
SB60	52	2.00
SB80	52	3.95
SBH15	118	61.00
SBH18	118	61.00
SCP12CW	107	6.70
SCP24CW	107	8.50
SCP64CW	107	12.15
SCP6CW	107	6.20
SFC12	83	5.60
SFC12SCPP	82	5.60
SFC2	83	3.10
SFC2SCPP	82	3.10
SFC6	83	3.85
SFC6SCPP	82	3.85
SFG1012	48	15.10
SFG1015	48	16.15
SFG1220	48	20.60
SFG820	48	17.15
SFR1012	48	15.10
SFT1010	48	14.30
SFT1212	48	15.50
SFT1515	48	17.95
SFV1015	48	15.75
SLL30	78	175.00
SPA14	55	9.35
SPASL14	55	9.35
SPO10CW	55	2.65
SPO11	55	5.05
SPO11CW	55	3.25
SPO13	55	8.30
SPO13CW	55	5.55
SPO8CW	55	2.40
SPOP10CW	55	2.65
SPOP11	55	5.05
SPOP11CW	55	3.25
SPOP13	55	8.30
SPOP13CW	55	5.55
SRB13	44	3.05
SRB13CW	44	4.10
SRB5	44	1.65
SRB5CW	44	2.10

ALPHA NUMERICAL LISTING WITH LIST PRICES

PRODUCT CODE NUMBER	PAGE NUMBER	LIST PRICE /GROUP 3
TC1418	167	1,000.00
TDC2029	167	920.00
TDC30	170	1,210.00
TDCR12	167	1,215.00
TG12	56	5.55
TG6	56	2.30
TG9	56	3.65
TGA11	56	4.35
TGA8	56	3.75
TGG6	56	3.75
TGG9	56	4.05
UC1000	131	380.00
UC250	131	245.00
UC500	131	280.00
UPC100	133	395.00
UPC101	133	395.00
UPC1200	141	1,675.00
UPC140	133	345.00
UPC160	133	350.00
UPC1600	141	2,420.00
UPC1600TR	141	2,460.00
UPC180	133	360.00
UPC400	136	525.00
UPC400TR	136	550.00
UPC600	141	1,095.00
UPC800	141	1,290.00
UPC800TR	141	1,300.00
UPCH400	144	1,095.00
UPCH4002	144	1,095.00
UPCH800	144	2,475.00
UPCH8002	144	2,475.00
UPCHBD800	144	720.00
UPCHBD8002	144	720.00
UPCHD400	144	710.00
UPCHD4002	144	710.00
UPCHT800	144	1,965.00
UPCHT8002	144	1,965.00
UPCHTD800	144	720.00
UPCHTD8002	144	720.00
UPCHW400	144	1,260.00
UPCHW4002	144	1,260.00

PRODUCT CODE NUMBER	PAGE NUMBER	LIST PRICE /GROUP 3
UPCS140	133	230.00
UPCS160	133	240.00
UPCS180	133	260.00
UPCS400	139	480.00
UPCS400CK	139	135.00
UPCSS160	133	240.00
UT881	Discontinued 1/1/09	
UT882	Discontinued 1/1/09	
WC100CW	45	37.90
WC100CWNH	45	21.80
WCR1220	110	94.00
WCR1220	113	94.00
WCS30	45	92.15
WW1000CW	43	9.95
WW1000L	43	0.95
WW1000LS	43	0.95
WW1500CW	43	12.95
WW250CW	43	4.45
WW250L	43	0.95
WW500CW	43	7.35

Cambro Warranty

Cambro Camtrays® and Camwear® Dinnerware have a five year guarantee against breakage. Camtherm Bulk Food Holding Cabinets hold a one-year warranty. Camshelving® has a one-year warranty on workmanship and a lifetime limited warranty against rust and corrosion, excluding mobile posts. For all other Cambro products, Cambro warrants to the original buyer a three-year pro-rated guarantee. If product proves defective during this time, Cambro grants a pro-rated credit of the original price toward replacement product. The warranty applies on all Cambro products only when used under normal foodservice industry conditions.

Photo credits:

Cambro products help foodservice operators throughout the world. To represent our global presence, images of Cambro products in use have been taken on locations throughout southern California, USA; in Cancun, Mexico; on the island of Rugen, Germany; and in the city of Huizhou, China. In particular, special thanks to the staffs of the Ambience Hotel, Rugen; Jin Hua Palace Hotel, Huizhou; Southern California Gas Company, Downey; Orange Coast College, Santa Ana and California Hospital, Los Angeles for their assistance in our photo shoots.

MERCHANDISING & CATERING EQUIPMENT COLOR CHART

Cambro provides a wide selection of colors to help you coordinate with your decor and color code items to simplify use. Color selections vary by product. Please see individual products for specific colors offered.

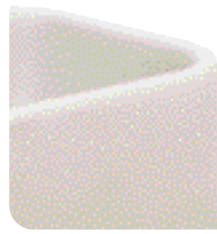

Gray (180)

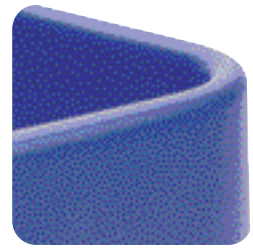

Navy Blue (186)

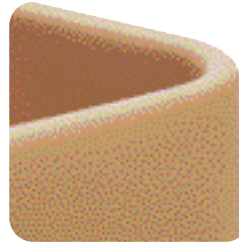

Coffee Beige (157)

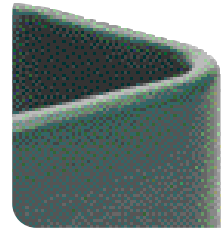

Green (519)



Black (110)

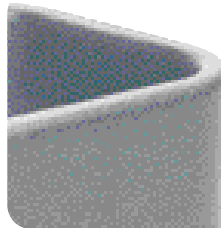

Granite Gray (191)

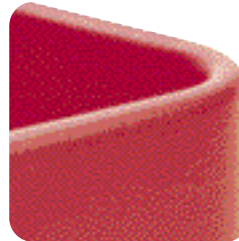

Hot Red (158)

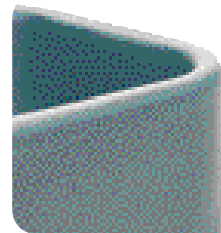

Granite Green (192)



Dark Brown (131)



Dark Taupe (417)

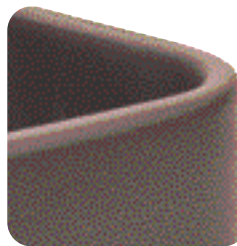

Dark Brown (131)

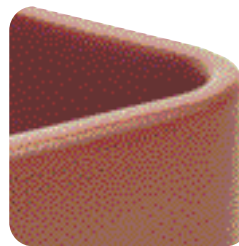

Brick Red (402)

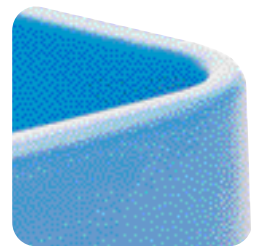

Cold Blue (159)

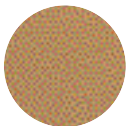

Coffee Beige (157)



Slate Blue (401)

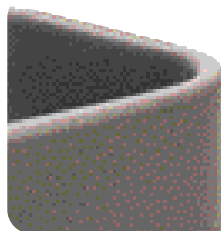

Granite Sand (194)



Black (110)

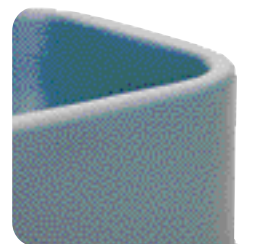

Slate Blue (401)



Speckled Gray (480)

Due to the catalog printing process, the colors shown may not be exact. For exact colors, contact Cambro or a Cambro Sales Representative for a color chip.

NEW FROM CAMBRO®



Camtread® Trays Designer Series
Page 23



Meal Delivery System - The Shoreline Collection
Page 34



Square Versa Camcovers®
Page 36

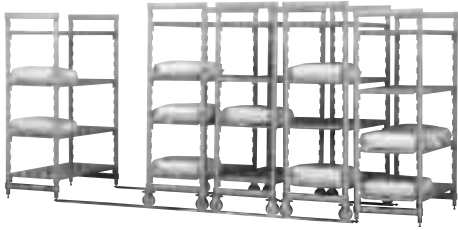

Camshelving® High Density Storage System
Page 64



84" Camshelving®
Page 71



Camshelving® Dome Drying
and Storage Cart
Page 75



Polypropylene Pizza Dough Boxes
Page 77



Seal Covers for
Camwear® CamSquares
Page 82



12" Camwear® Food Boxes
Page 90



Full Size Camwear®
and H-Pan™ Colander Pans
Page 96, 100



Camcarriers® S-Series
UPCSS160
Page 133

CAMBRO

WWW.CAMBRO.COM

CAMBRO U.S.A.
5801 Skylab Road, Huntington Beach, CA 92647 P.O. Box 2000, Huntington Beach, CA 92647-2000
Telephone: (714) 848-1555 Toll Free: (800) 854-7631 FAX: (714) 842-3430
Customer Service: (800) 833-3003
© 2009 Cambro Manufacturing Company. Printed in the U.S.A.

CAT2009US

All prices are in US dollars. All prices are subject to change without prior notice.



Cambro is a proud recipient of
the U.S. President's E-Award
for Excellence in Exporting.