



Owner's Manual

FOR THE TURBOCHEF i5™ AND i3™ RAPID COOK OVENS



For further information, call

800.90TURBO

or

+1 214.379.6000

The information contained in this manual is important for the proper installation, use, maintenance, and repair of this oven. Follow these procedures and instructions to help ensure satisfactory baking results and years of trouble-free service.

Errors – descriptive, typographic, or pictorial – are subject to correction. Specifications are subject to change without notice.

Please carefully read this manual and retain it for future reference.

Table of Contents

Safety Instructions

General Safety Information	i
Reducing Fire Risk	i
Grounding Instructions	ii
Power Cord Replacement	ii
Precautions to Avoid Possible Exposure to Excessive Microwave Energy	ii
RF Interference Considerations	ii

General Oven Information

Theory of Operation	1
Certifications	1
Dimensions	1
Electrical Specifications - i5 Oven	2
Electrical Specifications - i3 Oven	3
Oven Construction	4

Installation

Unpacking Instructions	4
Lifting and Placing the Oven	4
Installation Near Open Heat Source	5
Voltage Selection	5
Ventilation Requirements	5
Optional Installation Items	6
Oven Carts	6
Stacking Stand	6
Oven Restraint Kit	6
Oven Connect™	6
ChefComm Pro®	6
ChefComm Limited™	6

Maintenance and Cleaning	7
--------------------------	---

Oven Controls	10
---------------	----

Cooking	11
---------	----

The Info Mode

Overview of the Info Mode	14
Viewing Cook Counts/Time Logs	14
Viewing the Fault Log	14
Viewing the Service Numbers	15
Oven Options	15
Turn On/Off “Adjust Time” Screen	
Turn On/Off “Cook More” (Additional Cooking Options) Screen	
Turn On/Off Edit Mode	
Turn On/Off “Load Menu” Screen	
Access Network Setup	
Set Oven Type (i3 or i5)	
Network Setup	15
Setting the F2 Alarm	15
Resetting the Oven	15
Setting the Date/Time	16
Updating the Oven Menu	16
Making a Copy of the Oven Menu	17
Updating the Oven Firmware	17

The Edit Mode

Overview of the Edit Mode	17
Changing Set Temperatures	17
Changing Food Group/Item Name	18
Changing Cook Settings	18

Troubleshooting	19
------------------------	-----------

North America Limited Warranty	21
---------------------------------------	-----------

International Limited Warranty	23
---------------------------------------	-----------

Safety Instructions

Strictly adhere to the following safety precautions to reduce the risk of burns, electric shock, fire, injury, damage to oven or property near oven, or possible exposure to excessive microwave energy.

General Safety Information

- ✓ Read all instructions before using this appliance.
- ✓ Read and follow the specific “Precautions to Avoid Possible Exposure to Excessive Microwave Energy” found on page ii.
- ✓ This appliance must be grounded. Connect only to properly grounded outlet. See “Grounding Instructions” found on page ii.
- ✓ Install or locate this appliance only in accordance with the provided installation instructions.
- ✓ Some products such as whole eggs and sealed containers (e.g., closed glass jars) may explode and should not be heated in this oven.
- ✓ Use this appliance only for its intended uses as described in this manual.
- ✓ This appliance should be serviced only by qualified service personnel. Contact the nearest authorized service facility for examination, repair, or adjustment.
- ✓ Keep the cord away from heated surfaces.
- ✓ Use only utensils suitable for use with microwave ovens.
- ✓ The contents of feeding bottles and baby food jars must be stirred or shaken and the temperature checked before consumption, in order to avoid burns.
- ✓ Liquids, such as water, coffee, or tea are able to be overheated beyond the boiling point without appearing to be boiling. Visible bubbling or boiling when the container is removed from the microwave oven is not always present. **THIS COULD RESULT IN VERY HOT LIQUIDS SUDDENLY BOILING OVER WHEN THE CONTAINER IS DISTURBED OR A UTENSIL IS INSERTED INTO THE LIQUID.**
- ✓ This appliance is not to be used by children or persons with reduced physical, sensory or mental capabilities, or lack of experience and knowledge, unless they have been given supervision or instruction.
- ✗ **DO NOT** allow children to use this appliance. Children should be supervised to ensure that they do not play with the appliance.
- ✗ **DO NOT** use corrosive chemicals or vapors in this appliance - it is not designed for industrial or laboratory use.
- ✗ **DO NOT** operate this appliance if it has a damaged cord or plug, is not working properly, or has been damaged or dropped. See “Power Cord Replacement” found on page ii.
- ✗ **DO NOT** cover or block any openings on this appliance.
- ✗ **DO NOT** store this appliance outdoors.
- ✗ **DO NOT** use this product near water (e.g., near a kitchen sink, in a wet basement, near a swimming pool).
- ✗ **DO NOT** immerse the cord or plug in water.
- ✗ **DO NOT** let the cord hang over the edge of a table or counter.
- ✗ **DO NOT** use a water jet for cleaning. See “Daily Maintenance” (pages 7-9) for proper cleaning procedures.

Reducing Fire Risk

- ✓ Remove wire twist-ties from paper or plastic bags used to facilitate cooking in the oven.
- ✓ If materials inside the oven ignite, keep the oven door closed, turn the oven off, and disconnect the power cord or shut off power at the fuse or circuit breaker panel.
- ✓ If smoke is observed, switch off or unplug the oven. Keep the door closed to stifle any flames.
- ✗ **DO NOT** use the cook cavity for storage purposes (e.g., leaving paper products, cooking utensils, or food in the cavity when not in use).
- ✗ **DO NOT** overcook food. Carefully attend to the oven if paper, plastic, or other combustible materials are placed inside the oven to facilitate cooking.

Grounding Instructions

This appliance must be grounded. In the event of an electrical short circuit, grounding reduces the risk of electric shock by providing an escape wire for the electric current. This oven is equipped with a cord that has a grounding wire with plug, which must be plugged into an outlet that is properly installed and grounded. Consult a qualified electrician or serviceman if uncertain about the ability to follow grounding instructions or if doubt exists as to whether the appliance is properly grounded.

- x DO NOT use an extension cord. If the power cord is too short, have a qualified electrician or serviceman install an outlet near the appliance.

 **WARNING:** Improper grounding can result in risk of electric shock.

Power Cord Replacement

If the power cord is damaged, it must be replaced by the manufacturer, its service agent, or a similarly qualified person.

Precautions to Avoid Possible Exposure to Excessive Microwave Energy

- Do not attempt to operate this oven with the door open since open-door operation can result in harmful exposure to microwave energy. It is important not to defeat or tamper with the safety interlocks.
- Do not place any object between the oven front face and the door or allow soil or cleaner residue to accumulate on sealing surfaces.
- Do not operate the oven if it is damaged. It is particularly important that the oven door close properly and that there is no damage to the: (1) Door (bent), (2) hinges and latches (broken or loosened), (3) door seals and sealing surfaces.
- The oven should not be adjusted or repaired by anyone except properly qualified service personnel.

RF Interference Considerations

This oven generates radio frequency signals, and has been tested and determined to be in compliance with applicable portions of FCC part 18 requirements and to the protection requirements of Council Directive 89/336/EEC on the approximation of the laws of the Member States relating to electromagnetic compatibility at the time of manufacture. However, some equipment with sensitivity to signals below these limits may experience interference.

If your equipment experiences interference:

- ✓ Increase the physical separation between this oven and the sensitive equipment.
- ✓ If the sensitive device can be grounded, do so following accepted grounding practices.
- ✓ If battery-powered microphones are being affected, ensure that the batteries are fully charged.
- ✓ Keep sensitive equipment on separate electrical circuits if possible.
- ✓ Route intercom wires, microphone wires, speaker cables, etc. away from the oven.

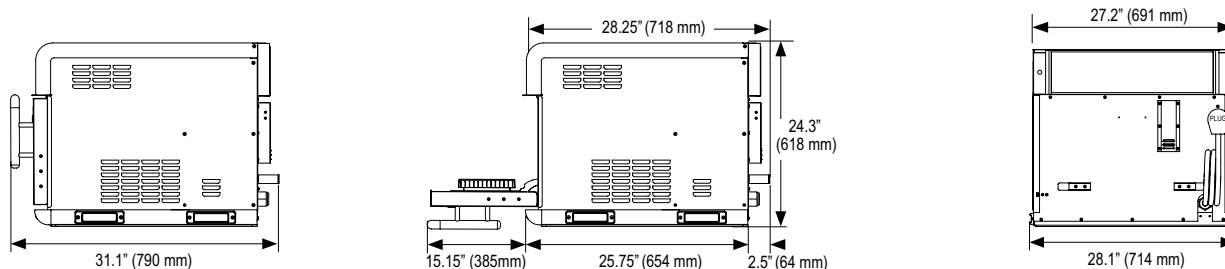

Figure 1: i5 Oven Dimensions

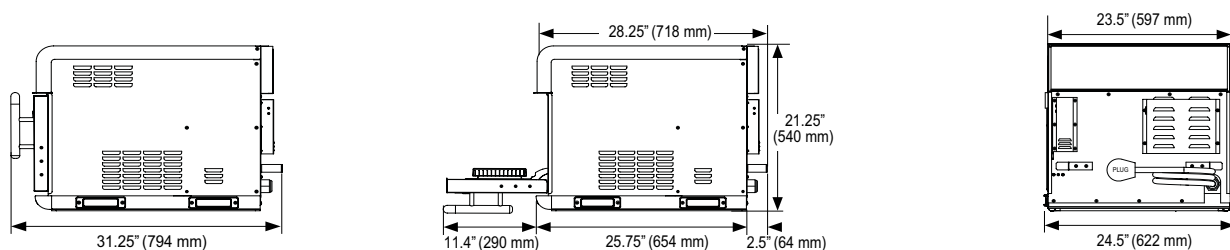

Figure 2: i3 Oven Dimensions

Theory of Operation

Utilizing TurboChef's patented technology to rapidly cook food without compromising quality, the i5 and i3 ovens maximize throughput and versatility with a large cavity size and the ability to cook with most any metal pan. The control system precisely coordinates independent top and bottom impinging airflow with top-launched microwave to deliver superior quality, throughput, and speed. Integral catalytic converters allow for UL®-certified ventless operation.

This manual includes instructions for installing, cleaning, and operating the i5 and i3 ovens. If you have questions that are not addressed in this manual, contact Customer Support (800.90TURBO, +1 214.379.6000) or your Authorized Distributor.

Certifications

cULus, UL EPH, TÜV, CE, FDA



Dimensions

Oven Dimensions

Measurement	i5 Oven	i3 Oven
Height	24.3" (618 mm)	21.25" (540 mm)
Width	28.1" (714 mm)	24.5" (622 mm)
Depth (door closed)	31.1" (790 mm)	31.25" (794 mm)
Depth (door open)	43.4" (1102 mm)	39.65" (1007 mm)
Weight	275 lb. (125 kg)	245 lb. (111 kg)

Measurement	i5 Oven	i3 Oven
Height	10" (254 mm)	6.9" (175 mm)
Width	24" (610 mm)	19.4" (493 mm)
Depth (door open)	16" (406 mm)	14.75" (375 mm)
Depth (door closed)	14" (356 mm)	12.75" (324 mm)
Volume	2.22 ft³ (63 liters)	1.14 ft³ (32.3 liters)

Measurement	i5 Oven	i3 Oven
Top	19" (483 mm)	19" (483 mm)
Sides	2" (51 mm)	2" (51 mm)

Electrical Specifications - i5 Oven

TurboChef recommends a Type D circuit breaker for all installations outside the US.

Single Phase

i5 US model (i5-9500-1)*
208/240 VAC, 60 Hz, 48 amps
Max Input: 9500/11500 watts
Plug: NEMA 6-50P

i5 BK model (i5-9500-6-BK)
220 VAC, 60 Hz, 48 amps
Max Input: 10000 watts
Plug: IEC 309, 3-pin

i5 LA model (i5-9500-7-LA)
220 VAC, 60 Hz, 48 amps
Max Input: 10000 watts
Plug: NEMA 6-50P

i5 UK model (i5-9500-2-UK)
230 VAC, 50 Hz, 48 amps
Max Input: 10000 watts
Plug: IEC 309, 3-pin

i5 JK model (i5-9500-8-JK) - 50 Hz
(i5-9500-10-JK) - 60 Hz
200 VAC, 50 or 60 Hz, 46 amps
Max Input: 9000 watts
Plug: PSE-marked, 3-blade

Multi Phase

i5 DL (USA) model (i5-9500-14-DL)*
208/240 VAC, 60 Hz, 30 amps
Max Input: 9500/11500 watts
Plug: NEMA 15-30P

i5 BD model (i5-9500-16-BD)
220 VAC, 60 Hz, 28 amps
Max Input: 10000 watts
Plug: IEC 309, 4-pin

i5 LD model (i5-9500-15-LD)
220 VAC, 60 Hz, 28 amps
Max Input: 10000 watts
Plug: NEMA 15-30P

i5 EW model (i5-9500-4-EW)
400 VAC, 50 Hz, 19 amps
Max Input: 10000 watts
Plug: IEC 309, 5-pin

i5 AU model (i5-9500-5-AU)
400 VAC, 50 Hz, 19 amps
Max Input: 10000 watts
Plug: Clipsal 5-pin

i5 KW model (i5-9500-12-KW)
400 VAC, 60 Hz, 19 amps
Max Input: 10000 watts
Plug: IEC 309, 5-pin

i5 ED model (i5-9500-3-ED)
230 VAC, 50 Hz, 28 amps
Max Input: 10000 watts
Plug: IEC 309, 4-pin

i5 SD model (i5-9500-13-SD)
230 VAC, 60 Hz, 28 amps
Max Input: 10000 watts
Plug: IEC 309, 4-pin

i5 JD model (i5-9500-9-JD) - 50 Hz
(i5-9500-11-JD) - 60 Hz
200 VAC, 50 or 60 Hz, 25 amps
Max Input: 10000 watts
Plug: PSE-marked, 4-blade

* North America models include a voltage sensor that detects 208 or 240 VAC. The voltage sensor does not compensate for lack-of or over-voltage installations.

Electrical Specifications - i3 Oven

TurboChef recommends a Type D circuit breaker for all installations outside the US.

Single Phase

i3 US model (i3-9500-1)*

208/240 VAC, 60 Hz, 40 amps
Max Input: 8300/9600 watts
Plug: NEMA 6-50P, 8/3

i3 BK model (i3-9500-6-BK)

220 VAC, 60 Hz, 40 amps
Max Input: 8800 watts
Plug: IEC 309, 3-pin

i3 LA model (i3-9500-7-LA)

220 VAC, 60 Hz, 40 amps
Max Input: 8800 watts
Plug: NEMA 6-50P

i3 UK model (i3-9500-2-UK)

230 VAC, 50 Hz, 40 amps
Max Input: 9200 watts
Plug: IEC 309, 3-pin

i3 JK model (i3-9500-8-JK) - 50 Hz (i3-9500-10-JK) - 60 Hz

200 VAC, 50 or 60 Hz, 40 amps
Max Input: 8000 watts
Plug: PSE-marked, 3-blade

Multi Phase

i3 DL (USA) model (i3-9500-14-DL)*

208/240 VAC, 60 Hz, 24 amps
Max Input: 8600/9900 watts
Plug: NEMA 15-30P

i3 BD model (i3-9500-16-BD)

220 VAC, 60 Hz, 24 amps
Max Input: 9100 watts
Plug: IEC 309, 4-pin

i3 LD model (i3-9500-15-LD)

220 VAC, 60 Hz, 24 amps
Max Input: 9100 watts
Plug: NEMA 15-30P

i3 EW model (i3-9500-4-EW)

400 VAC, 50 Hz, 14 amps
Max Input: 9500 watts
Plug: IEC 309, 5-pin

i3 AU model (i3-9500-5-AU)

400 VAC, 50 Hz, 14 amps
Max Input: 9500 watts
Plug: Clipsal 5-pin

i3 KW model (i3-9500-12-KW)

400 VAC, 60 Hz, 14 amps
Max Input: 9500 watts
Plug: IEC 309, 5-pin

i3 ED model (i3-9500-3-ED)

230 VAC, 50 Hz, 24 amps
Max Input: 9500 watts
Plug: IEC 309, 4-pin

i3 SD model (i3-9500-13-SD)

230 VAC, 60 Hz, 24 amps
Max Input: 9200 watts
Plug: IEC 309, 4-pin

i3 JD model (i3-9500-9-JD) - 50 Hz (i3-9500-11-JD) - 60 Hz

200 VAC, 50 or 60 Hz, 23 amps
Max Input: 8000 watts
Plug: PSE-marked, 4-blade

* North America models include a voltage sensor that detects 208 or 240 VAC. The voltage sensor does not compensate for lack-of or over-voltage installations.

Oven Construction

Exterior

- Two-tone stainless steel front, top, and sides
- 304 stainless steel removable grease pan
- Ergonomic door handle
- Rubber seal for surface mounting
- Side handles for lifting

Interior

- 304 stainless steel interior
- Fully-insulated cook chamber
- Removable rack
- Top and bottom jetplates

Installation

Install or locate this appliance only in accordance with the instructions below.

Unpacking Instructions

1. Remove oven from packaging.
2. Before discarding packaging, check it thoroughly for accessories, consumables, and additional literature.
3. Discard packaging.
4. Check cook cavity thoroughly for accessories, consumables, and additional literature.
5. Discard any packaging in cook cavity.

Lifting and Placing the Oven

- !** **WARNING:** The i5 oven weighs approximately 275 lb. (125 kg); the i3 oven weighs approximately 245 lb. (111 kg). Never lift with fewer than two people.

- !** **WARNING:** Lift only by using the provided hand grips (Figure 3, below). Never lift the oven by the door handle.

- !** **WARNING:** The oven must be properly placed on the table or countertop at all times. TurboChef will not recognize a fallen oven as a warrantable claim and is not liable for any injuries that may result.

- !** **WARNING:** This oven is not intended for built-in installation (i.e., installing the oven in any structure that surrounds the oven by five or more sides). Be sure to provide a minimum of 2" (51 mm) clearance for all sides and 19" (483 mm) clearance for the top.

1. Prepare a surface that is at least 30" (762 mm) deep and capable of supporting
 - 280 lb. (127 kg) if installing an i5 oven
 - 250 lb. (114 kg) if installing an i3 oven
 If installing onto an oven cart, make sure the wheels/casters are locked.
2. Position one or more persons at the front and back of the oven.
3. Place hands into grips (see Figure 3) and lift.
4. Place the oven on the prepared surface.
5. Install the oven rack or other provided cooking surface.
6. Plug in the oven.

NOTE: The oven is primarily serviced through its top. **DO NOT** install shelving directly over the unit. The operator will be responsible for service charges incurred as a result of added time required to access the top of the oven.

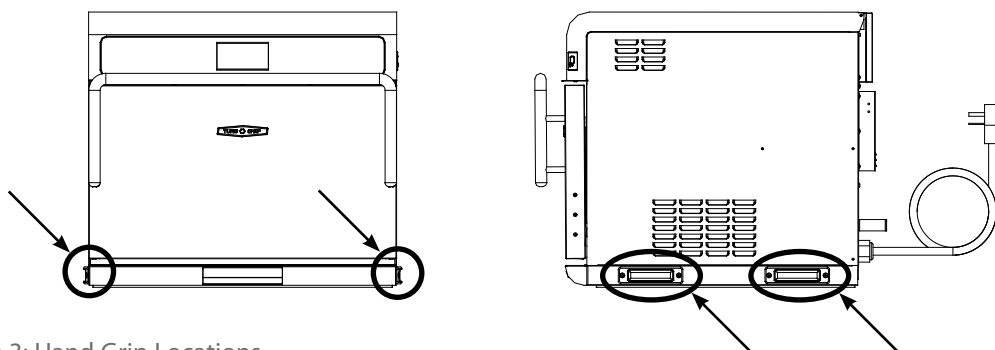

Figure 3: Hand Grip Locations

Installation Near Open Heat Source

See Figure 5. When placing a TurboChef oven near an open heat source, strictly adhere to the following:

- If the oven is being placed near a grill or stove, a divider must exist between the oven and the open heat source, with a minimum of 6" (152 mm) between the oven and the divider.
- If the oven is being placed near a fryer, a divider must exist between the oven and fryer, with a minimum of 12" (305 mm) between the oven and the divider.
- The height of the divider must be greater than or equal to the height of the oven:
 - i5 oven: 24.3" (618 mm)
 - i3 oven: 21.5" (540 mm)
- Verify oven location has a minimum 19" (483 mm) clearance on top and minimum 2" (51 mm) of clearance on each side.

Voltage Selection

For North America oven models, the oven will detect 208 or 240 incoming voltage.

The initial voltage selection is typically completed before the oven is used by the customer. However, if incoming voltage for the store is different than the preset voltage, the operator will be required to select either 208 or 240 after pressing the On/Off key to turn on the oven. The correct voltage will be enlarged on the screen, identifying which option to select (see Figure 4 adjacent).

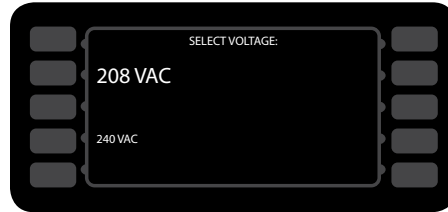

Figure 4: Selecting Voltage

Ventilation Requirements

The TurboChef i5 and i3 ovens has been approved by Underwriter's Laboratory for ventless operation (UL KNLZ listing) for all food items except for foods classified as "fatty raw proteins." Such foods include bone-in, skin-on chicken, raw ham-burger meat, raw bacon, raw sausage, steaks, etc. If cooking these types of foods, consult local HVAC codes and authorities to ensure compliance with ventilation requirements.

To ensure continued compliance with all health, building, and fire codes, you are required to maintain clean and sanitary conditions around your oven at all times.

NOTE: In no event shall the manufacturer assume any liability for damages or injuries resulting from installations which are not in compliance with the instructions and codes previously listed. Failure to comply with these instructions could result in the issuance of a temporary cease and desist order from the local health department until the environment concerns are addressed.

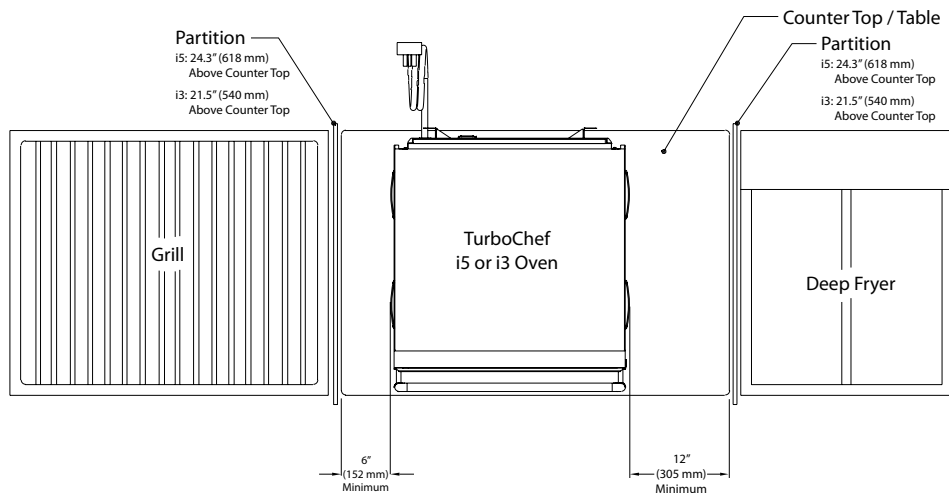

Figure 5: Installation Near Open Heat Source

Optional Installation Items

See Figure 6, below and Figure 7, page 7.

TurboChef Oven Carts

- Part Number: NGC-1217-1
Height: 24" (610 mm)
Width: 27.8" (706 mm)
Depth: 26.625" (676 mm)
- Part Number: NGC-1217-2
Height: 17.3" (439 mm)
Width: 27.8" (706 mm)
Depth: 26.625" (676 mm)
- Part Number: NGC-1217-3
Height: 32" (813 mm)
Width: 27.8" (706 mm)
Depth: 26.625" (676 mm)

TurboChef Stacking Stand

- Part Number: i5-9369
Height: 44.6" (1133 mm)
Width: 32.5" (826 mm)
Depth: 26.5" (673 mm)

NOTE: The stacking stand can only be used with the 17.3" (439 mm) oven cart (P/N: NGC-1217-2).

Oven Restraint Kit

Part Number: TC3-0242

⚠ WARNING: The Oven Restraint Kit will not prevent the oven from falling off a countertop if the oven is pulled off or allowed to slide off the edge. Installation instructions are included with the kit.

ChefComm Pro

Part Number: CON-7006

ChefComm Pro is a computer program that allows users of any TurboChef oven to easily create, update, preview, and distribute menu settings. You can also save the menu settings to a smart card or USB device. For more information, call TurboChef Service at 800.90TURBO or +1 214.379.6000.

ChefComm Limited

Part Number: CON-7016

ChefComm Limited is the same as ChefComm Pro, except it does not allow menu editing. It is ideal for those who need to receive menu settings, but should not be allowed to edit them.

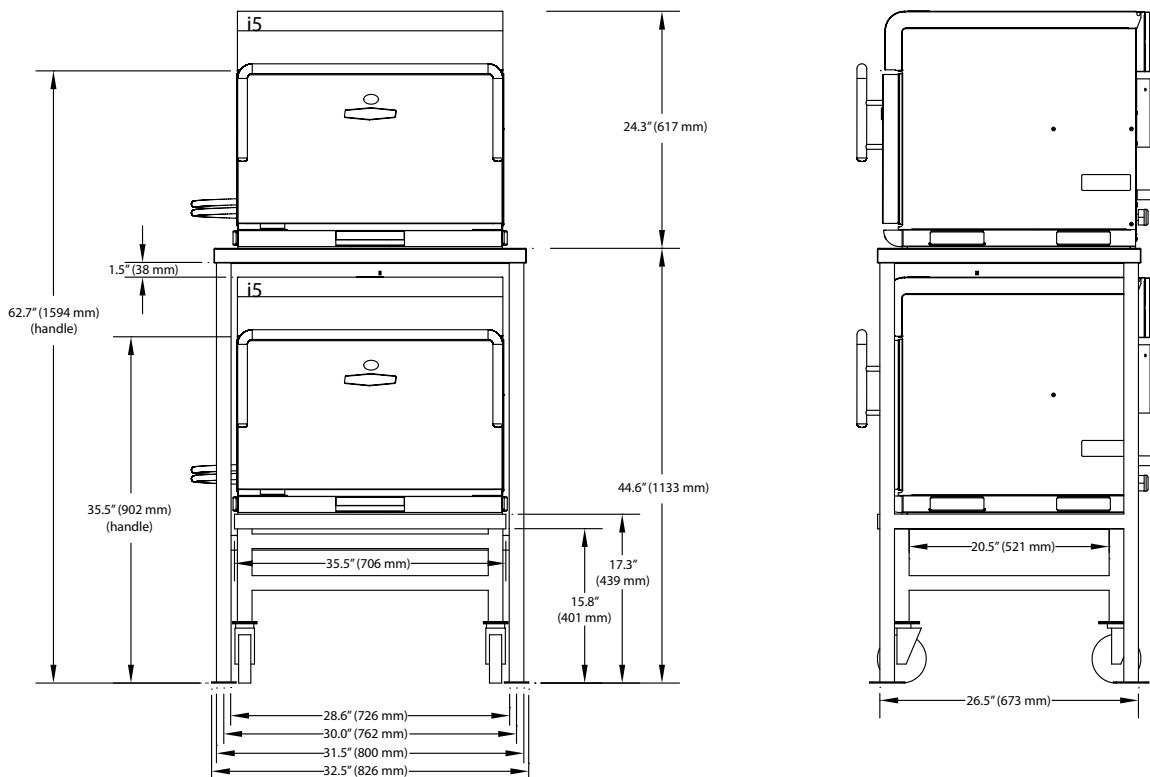

Figure 6: i5 Oven Cart and Stacking Stand Dimensions

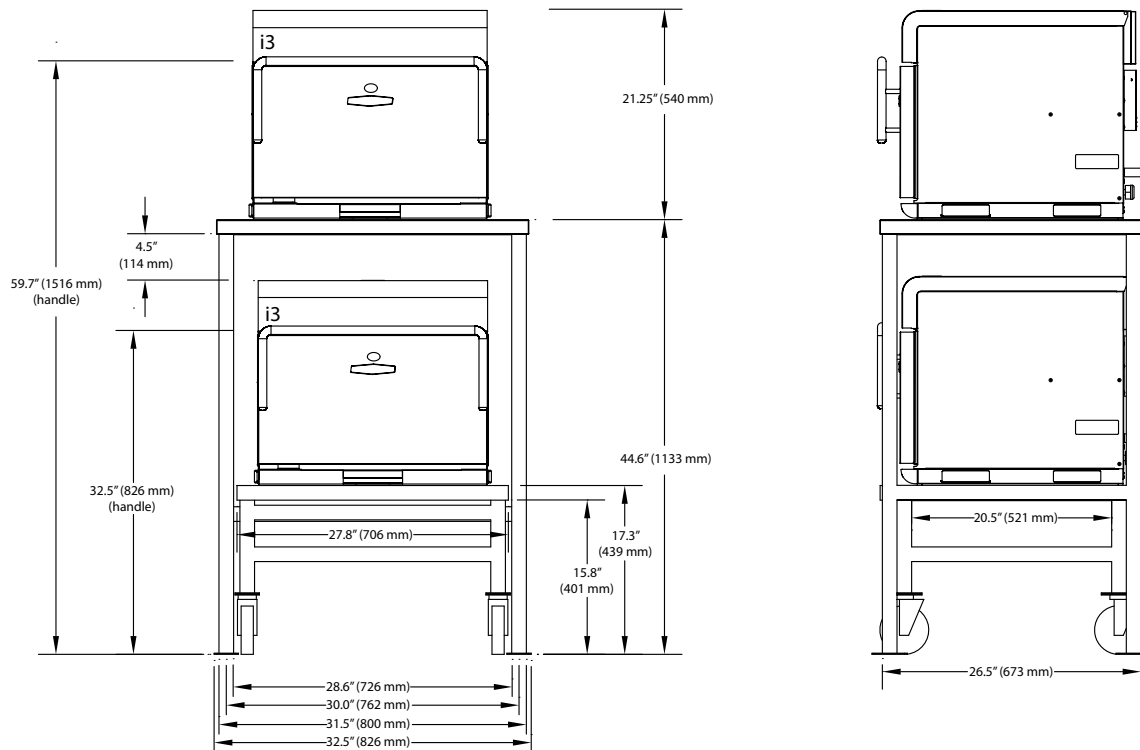

Figure 7: i3 Oven Cart and Stacking Stand Dimensions

Daily Maintenance

The following steps will help maintain your oven. Use only TurboChef Oven Cleaner and Oven Guard. The use of any other cleaning products can damage critical oven components, resulting in a non-warranty service call.

Supplies and Equipment

- TurboChef Oven Cleaner (Part Number: 103180)
- TurboChef Oven Guard (Part Number: 103181)
- Nylon scrub pad, cleaning towel, disposable gloves, protective eyewear, dust mask (optional), pair of tongs wrapped with towel (optional - see step 11, page 9)

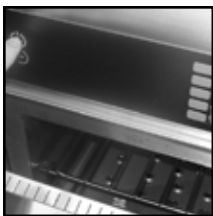

Step 1

Step 1: Prepare the Oven

⚠ WARNING: The oven operates at approximately 500°F (260°C) and may cause injury if not allowed to cool properly.

- Turn off the oven by pressing the On/Off key.
- Slightly open the oven door. Cooling takes approximately 40 minutes.
- DO NOT attempt to clean the oven until the oven displays “Oven Off.”

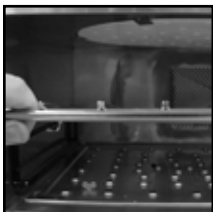

Step 2

Step 2: Remove and Clean the Wire Rack

⚠ WARNING: Be sure the oven interior is cool before you remove the wire rack.

- Wash, rinse, and sanitize the wire rack.

Continued on pages 8-9.

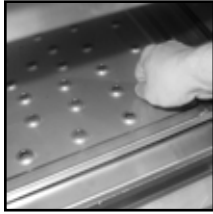

Step 3



Step 4



Step 5



Step 6.1

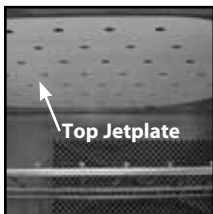

Step 6.2

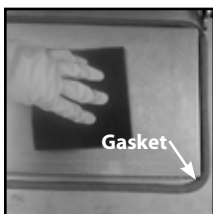

Step 7

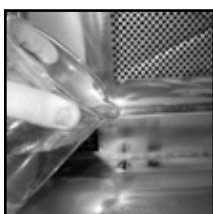

Step 8

Step 3: Remove and Clean the Lower Jetplate

- Unscrew the two thumb screws on the lower jetplate.
- Lift the lower jetplate by gripping the thumb screws.
- Remove the lower jetplate.
- Wash, rinse, and sanitize the lower jetplate.

⚠ CAUTION: DO NOT remove the top ceramic jetplate or glass inserts; breakage will result in a non-warranty service call.

Step 4: Remove and Clean the Lower Air Diverter

- Remove the lower air diverter.
- Wash, rinse, and sanitize the lower air diverter.

⚠ WARNING: DO NOT discard the lower air diverter. The oven will not work without the lower air diverter installed.

Step 5: Wipe the Oven Interior

- Wipe large particles from the oven interior with a damp towel.

Step 6: Clean the Oven Interior

- Spray oven cleaner onto the top, bottom, and sides of the oven interior.

⚠ CAUTION: DO NOT spray oven cleaner into the holes on the back oven wall. Doing so can damage critical oven components, resulting in a non-warranty service call.

- Allow Oven Cleaner to penetrate stains for five minutes.
- Clean the oven interior with a nylon scrub pad.

NOTE: The i5 oven top jetplate (Figure *Step 6.2*) is ceramic. The i3 oven top jetplate is either ceramic or metal with glass inserts.

⚠ CAUTION: DO NOT apply pressure to the ceramic or glass portion of the top jetplate when wiping; breakage will result in a non-warranty service call.

⚠ CAUTION: DO NOT remove the top ceramic jetplate or glass inserts; breakage will result in a non-warranty service call.

Step 7: Clean and Dry the Oven Door

⚠ CAUTION: DO NOT spray oven cleaner directly onto the oven door gasket (Figure *Step 7*) or saturate it with water.

⚠ CAUTION: DO NOT scrub or attempt to clean the oven door gasket (Figure *Step 7*). Doing so may cause the oven door to misalign, resulting in a non-warranty service call.

- Clean the oven door with oven cleaner and a nylon scrub pad.
- Wipe the oven door with a damp towel.

Step 8: Rinse the Oven Interior

⚠ CAUTION: DO NOT use a hose or water jet for cleaning. Doing so can damage critical oven components, resulting in a non-warranty service call.

- Rinse the oven interior with clean water.
- Dry the oven interior with a clean towel.



Step 9

Step 9: Apply TurboChef Oven Guard

- Spray Oven Guard onto a clean towel.
- Wipe the interior oven walls and the inside of the oven door.

⚠ CAUTION: DO NOT apply Oven Guard to the oven door gasket. Doing so may damage the gasket, resulting in a non-warranty service call.

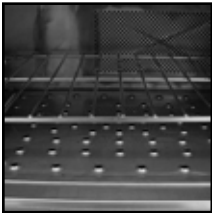

Step 10

Step 10: Reinstall Components

- Reinstall the lower air diverter.
- Reinstall the lower jetplate. Screw in the two thumb screws to lock the lower jetplate in place.
- Reinstall the wire rack and close the oven door.

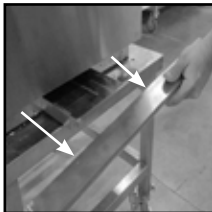

Step 11

Step 11: Clean the Drain Pan

- Remove the lower front panel to access the drain pan (Figure *Step 11*). The panel is attached via four clips and pulls off from the front.

NOTE: Certain i5 oven models do not require you to remove the lower front panel to access the drain pan.

- Remove the drain pan entirely from the bottom of the oven.
- Using a pair of tongs wrapped with a towel (TurboChef recommendation), wipe the inside of the drain pan slot.
- Empty, clean, and reinstall the drain pan.

⚠ CAUTION: If cleaning an i5 oven that does not require you to remove the lower front panel, ensure the outer edge of the drain pan is flush with the oven door (i.e., not sticking out). Failure to do so will damage the oven door, resulting in a non-warranty service call.



Step 12

- Reinstall the lower front panel. Ensure all four clips on the lower front panel are engaged and the edge of the panel is flush with the oven door (i.e., not sticking out).



Step 13

Step 12: Clean the Oven Exterior

- Wipe the oven exterior with a clean, damp towel.

⚠ CAUTION: DO NOT spray chemicals into any openings, such as the louvers on the side panels or the rear vent catalyst housing. Doing so can damage critical oven components, resulting in a non-warranty service call.

Step 13: Clean the Air Filter (Once Per Week)

- Remove the air filter from the back panel.
- Rinse the filter with hot water.
- DO NOT use a water jet. Doing so will shorten the life of the filter.
- Reinstall the air filter.

⚠ CAUTION: DO NOT operate the oven without the air filter in place.

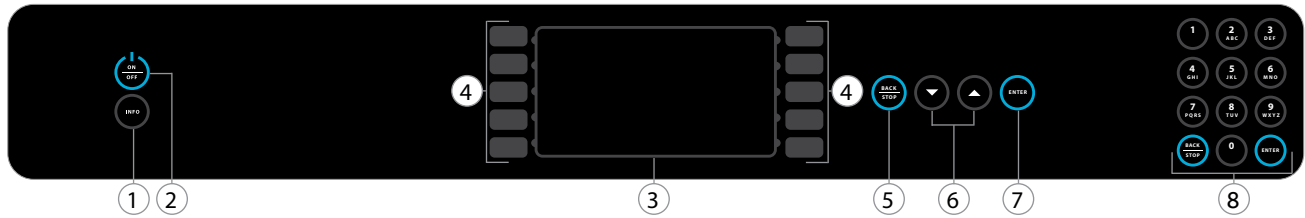

Figure 8: Oven Controls

Oven Controls

1. Info Key

When the oven is off or cooling down, press to access the INFO MODE (see page 14).

2. On/Off Key

Press to turn the oven on (begin warmup) or off (cool down), or to exit INFO MODE (page 14).

3. Display

The display shows information relevant to the current oven operation and/or user options.

4. Soft Keys

There are ten soft keys - five to the left and right of the display. Press a soft key to select an option adjacent to that key on the display.

NOTE: Soft keys are labeled L1-L5 and R1-R5 in this manual (where applicable) for easier identification and reference.

5. Back/Stop Key

When the oven is cooking, press the Back/Stop key to immediately terminate a cook cycle.

When the oven is ready to cook (i.e., warmed up and waiting for a cook command), or in the INFO MODE (see page 14), press the Back/Stop key to return to the previous screen.

6. Up and Down Keys

When the oven is ready to cook (i.e., warmed up and waiting for a cook command), press the Up or Down key to view additional food groups (if applicable).

When the oven is in the INFO MODE (see page 14), press to navigate between screen 1 and 2.

When editing a food item, press to navigate between editable fields (Figure 32, page 18).

7. Enter Key

Press the Enter key to confirm a setting change in the Options Screen (Figure 24, page 14), when saving changes to food item settings (Figure 32, page 18), or whenever instructed by the oven screen.

8. Numeric Keypad

Use the numeric keypad to enter access passwords or modify cook settings (Figure 32, page 18). The numeric keypad also contains a Back/Stop key and an Enter key, which are functionally identical to Items 5 and 7.

Cooking

The oven is preprogrammed with recipe settings at the time of manufacture and is ready to operate out of the box. If these settings are erased, new menu settings must be either loaded via smart card/USB drive (page 15) or programmed manually (pages 17-18). **The oven will not cook unless settings are present.**

Note that the steps below are not always sequential. Typically, multiple items will be cooked before cooling the oven (Step 10).

Step 1: Turn the Oven On

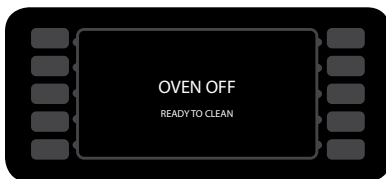

Figure 9: Oven Off

When the oven is off (Figure 9), the oven temperature is below 150°F (66°C), but the display and keypad remain on.

Press the On/Off key to turn the oven on.

Step 2: Select Cook Temperature



Figure 10: Cook Temperature Select

The oven stores two different cook temperature settings (see page 17 for more information). Each temperature setting has 10 food groups assigned to it, each consisting of 10 food items (100 items per temperature setting). The operator will be able to cook only recipes associated with the selected temperature setting.

To select a temperature, press the adjacent soft key.

NOTE: If both temperature settings are the same, this screen will be bypassed and access to all 200 food items will be allowed.

Step 3: Warming Up



Figure 11: Warming Up

During this step, the oven warms to the selected or pre-set temperature.

Step 4: Soaking



Figure 12: Soaking

Once the oven temperature reaches the set point, the oven will continue to warm for eight minutes to ensure the cook cavity surfaces absorb enough heat so as to not affect cooking results. This process is called “soaking.”

Step 5: Ready to Cook



Figure 13: Group Select

⚠ WARNING: Inside of oven and oven door are hot!

1. Place the food into the oven.
2. Select a food group by pressing its adjacent soft key (Figure 13), or press the Up or Down key for additional food groups, if available.
3. Select an item (Figure 14) to cook by pressing its adjacent soft key.



Figure 14: Item Select

Step 6: Adjusting the Time

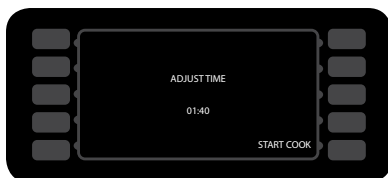

Figure 15: Adjust Time

The Adjust Time option is turned off by default. If you want the ability to modify the cook time before each cook cycle, this feature can be turned on from the “Options” screen (see page 15).

1. If the “Adjust Time” screen appears, change the cook time (if required) using the number keys.
2. Press Enter or the bottom-right soft key to confirm and begin cooking.

Step 7: Cooking



Figure 16: Cooking

NOTE: To immediately terminate a cook cycle, press the Back/Stop key.

NOTE: If the oven door is opened during a cook cycle, the cycle will pause until the door is closed and “Resume” is selected.

Step 8: Remove Food from Oven



Figure 17: Cooking Done

 **WARNING:** Dish and inside of oven/oven door are hot!

Open the oven door and check/remove food.

Step 9: Cook More Option

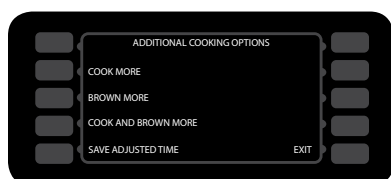

Figure 18: Cook More

The “Additional Cooking Options” screen is turned off by default. If you want the ability to cook a product beyond the standard cook time, you can enable this feature from the “Options” screen (see page 15).

If the “Additional Cooking Options” screen appears and the food product requires more cooking:

- Select “cook more” if the inside of the food item is undercooked.
- Select “brown more” if the outside of the food item requires more browning or crispness.
- Select “cook and brown more” if both the inside and outside of the food item are not done.
- Select “save adjusted time” to save any change to the cook time made during Step 6. Note that this option is not available if “Adjust Time” is disabled.
- Select “exit” to return to the food group selection screen.

Step 10: Cooling Down

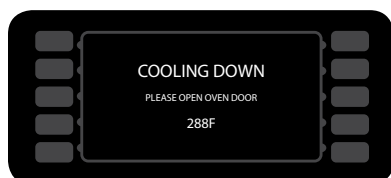

Figure 19: Cooling Down

During this step, the oven blows cool air into the cook cavity to return it to room temperature.

When finished cooking for the day, press the On/Off key to turn the oven off and begin cooling down.

Overview of the Info Mode

The INFO MODE serves four main purposes:

1. To display general oven information.
2. To provide access to TEST MODE and additional diagnostic tools for service technicians.
3. To turn oven options and features on/off.
4. To update oven settings.

To access the INFO MODE, simply press the Info key when the oven is either off or cooling down. To toggle between the Info screen 1 and 2, press the Up or Down key.

Screen 1 of the INFO MODE (Figure 20) includes:

- Oven serial number
- Oven software version
- Menu part number and revision
- Last temperature selected to cook
- Current electrical compartment temperature
- Counters (scroll by pressing adjacent soft key)
- Operating voltage (USA models only)
- Access to the fault log
- Access to service phone numbers

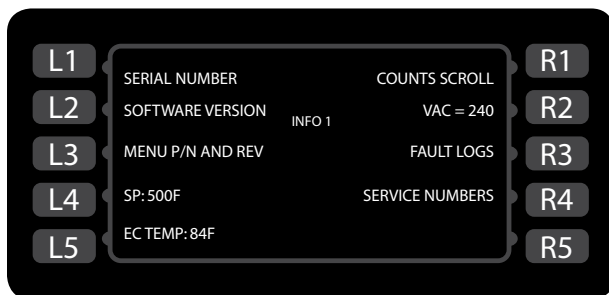

Figure 20: Info Mode Screen 1

Screen 2 of the INFO MODE (Figure 21) includes:

- Access to TEST MODE
- Access to the “Options” screen
- Language (set by pressing adjacent soft key - not available on all models)
- Access to date/time settings
- Sound (press adjacent soft key to increase/decrease the volume)
- Access to the “Load Menu” screen
- F2 alarm on or off (see page 15 for details)

Viewing Cook Counter/Time Logs

From the INFO MODE (Figure 20), press the R1 soft key:

- Once to display the cook counter.
- Twice to display total cook time.
- Three times to display total magnetron time.
- Four times to display total “oven on” time.

Viewing the Fault Log

From the INFO MODE (Figure 20), press the R3 soft key to view the fault log (Figure 22). To view a detailed log of each fault occurrence (Figure 23), press the soft key adjacent to the fault code.

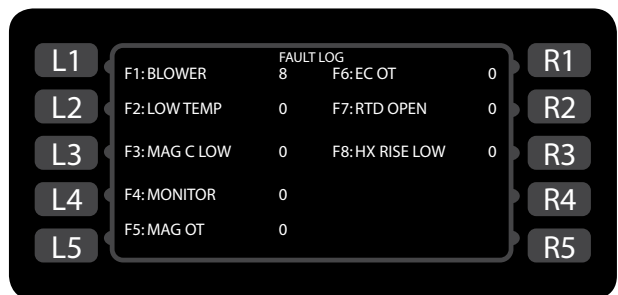

Figure 22: Fault Log

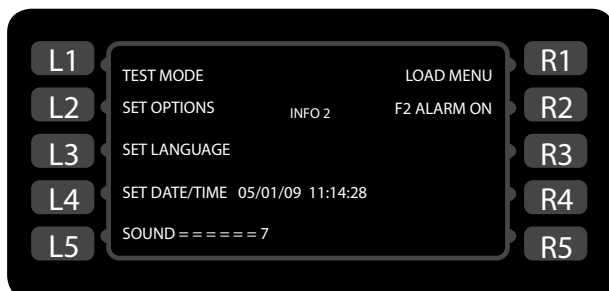

Figure 21: Info Mode Screen 2



Figure 23: Fault Detail

Viewing the Service Numbers

From the INFO MODE (Figure 20), press the R4 soft key to view technical support contact info.

Oven Options

From screen 2 of the INFO MODE (Figure 21), press the L2 soft key to access the “Options” screen (Figure 24). When prompted, enter the password 9 4 2 8 and press the Enter key.

From the “Options” screen, the following oven options can be set:

- Turn on/off “Adjust Time” screen (page 12 for more details)
- Turn on/off “Cook More” (Additional Cooking Options) screen (page 13 for more details)
- Turn on/off Edit Mode (page 17 for more details)
- Turn on/off “Load Menu” screen (page 16 for more details)
- Access Network Setup (see below)
- Set Oven Type: Ensure this option is set to “i3” for i3 ovens and “i5” for i5 ovens.
- Demo Mode (TurboChef use only)

Network Setup

From the network setup screen, the following information may be entered to configure the oven for networking:

- IP Address
- Mask
- Gateway (GW)
- Domain Name Servers (DNS 1/DNS 2)

Each set of numbers may be edited in strings of three digits:

1. To edit the first string, press the Down key and then enter the first three digits.
2. Press the Down key again and enter the next three digits.
3. Repeat until all digits have been entered for each field.
4. Press “Save.”

If DHCP is turned on (top-left corner of screen), the oven will automatically be assigned an IP address when connected to a local area network (if an IP address is available). TurboChef recommends leaving DHCP off to ensure the IP address on the oven does not change.

Using Oven Connect requires each oven to be networked. For help determining the correct network setup information, contact your network administrator.

Setting the F2 Alarm

Under normal operation, the F2 alarm will terminate a cook cycle if the CC temperature falls below 84°F (47°C) of the set point. Turning off the F2 alarm will prevent a cook cycle from being terminated if the fault is discovered. In either event, the fault will be logged and should necessitate a service call.

To turn the F2 alarm on or off, press the R2 soft key from the Info 2 screen (Figure 21, page 14).

Resetting the Oven

Resetting the oven is one way to potentially clear an error message, should one occur. From the “Cooling Down” or “Oven Off” screen, press and hold the Info key for five seconds.

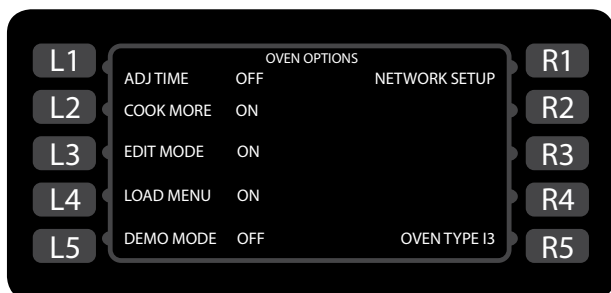

Figure 24: Options Screen

Setting the Date/Time

Having an accurate date and time is important for logging oven counts, diagnostics, and fault conditions, should any occur. The oven time and date are set at the time of manufacture; however, the operator may at some point be required to make an adjustment.

From screen 2 of the INFO MODE (Figure 21), press the L4 soft key to access the “Set Date/Time” screen (Figure 25).

To set the date and time,

1. Use the L3 and R3 soft keys (middle left and middle right) to navigate between fields.
2. Use the number keypad to enter the month, day, and year, followed by the hour and minute.

NOTE: The clock is 24-hour (20:30=8:30 p.m.).

3. Select “Save” to save your changes or “Cancel” to exit the screen.

NOTE: The oven will not retain the time if it is left unplugged for two or more weeks.

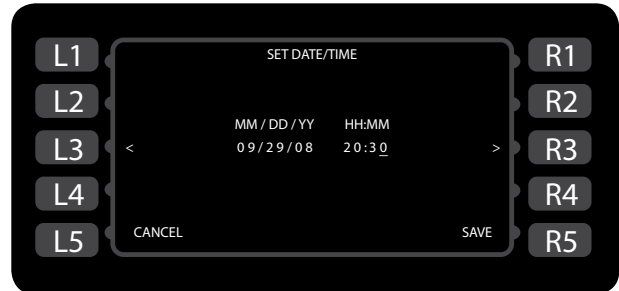

Figure 25: Set Date/Time

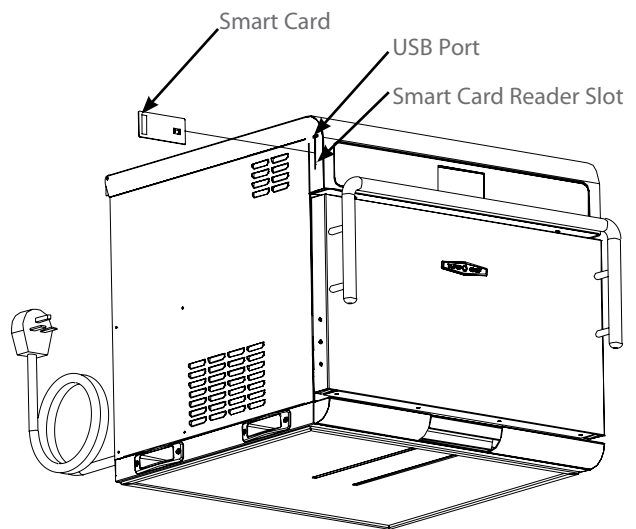

Figure 26: Inserting Smart Card/USB Device

Updating the Oven Menu

From screen 2 of the INFO MODE (Figure 21, page 14), press the R1 soft key to access the “Load Menu” screen (Figure 27).

NOTE: This feature can be turned on or off via the “Options” screen (Figure 24).

To load a menu to the oven from a smart card,

1. Insert the smart card (Figure 26).
2. Press the L1 soft key (Figure 27).
3. Verify the oven beeps and reads “FINISHED” (Figure 28).

To load a menu from a USB drive,

1. Verify the menu on the USB drive is named MENU.BIN.
2. Verify the menu on the USB drive is in a folder named TC_MENU. This folder must not be a sub-folder of any other folder.
3. Insert the USB drive (Figure 26).
4. Press the L4 soft key (Figure 27).
5. Verify the oven beeps and reads “FINISHED.”

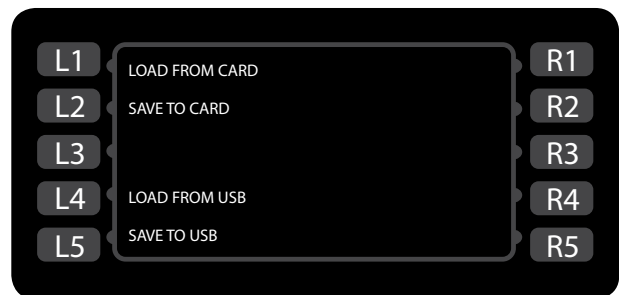

Figure 27: Load Menu Screen

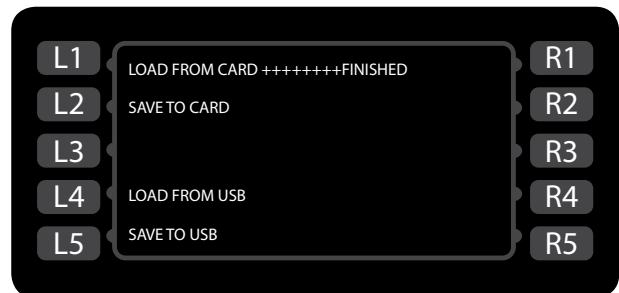

Figure 28: Loading...Finished

Making a Copy of the Oven Menu

To save a copy of the oven menu to a **smart card**,

1. Insert the smart card (Figure 26).
2. Press the L2 soft key (Figure 27).
3. Verify the oven beeps and reads “FINISHED.”

To save a copy of the oven menu to a **USB drive**,

1. Insert the USB drive (Figure 26).
2. Press the L5 soft key (Figure 27).
3. Verify the oven beeps and reads “FINISHED.”

Updating the Oven Firmware

Updating the oven firmware is different than updating menu settings. Perform the below procedure whenever enhancements to oven operation are made available.

⚠ CAUTION: The oven will be inoperable if the firmware update is unsuccessful!

From the Oven Off screen,

1. Insert the smart card (see Figure 26). If multiple smart cards are required, ensure the correct smart card is loaded first.
2. From the COOLING DOWN or OVEN OFF mode, press and hold the Info key until the oven resets (approximately 5 seconds).
3. When the oven beeps one long high tone, insert the second card.
4. When the oven beeps one long high tone, remove the second smart card. The oven will reset, indicating that the update is complete.

NOTE: If the update is unsuccessful, the display will remain off and the oven will beep one long, low tone. If this occurs, repeat the above procedure. If the update fails multiple times, contact TurboChef as a card may be damaged or the version may be incorrect.

Overview of the Edit Mode

The EDIT MODE serves three main purposes:

1. To edit cook temperatures.
2. To edit names of food groups and items.
3. To edit food item settings.

To access the EDIT MODE,

1. Enable it from the “Options” screen (page 15).
2. Press the On/Off key to return the oven to the “Cooling Down” or “Off” screen.
3. Press the On/Off key again to enter EDIT MODE.

Changing Set Temperatures

The oven can store two set temperatures. Think of each temperature as a “block” of 10 food groups with 10 items each, or 100 total food items.

If a menu was loaded from a smart card or USB (page 16), the temperatures are already set - they do not need to be changed. **The set temperature should never be changed during normal operation.**

Changing the set temperature is not advised as a solution for products that are not cooking properly. Rather, refer to pages 19-20 if recipe settings are not cooking as desired.

To change a set temperature,

1. Place the oven in EDIT MODE (see adjacent).
2. Select the temperature to change by pressing the adjacent soft key (Figure 29).
3. Using the numeric keypad, enter the new set temperature.
4. Press the Enter key to confirm the change, or the Back/Stop key to cancel.



Figure 29: Temperature Edit Screen

Changing Food Group/Item Name

To change a food group, item, or quantity name:

1. Place the oven in Edit Mode (see page 17).
2. Press the R2 soft key to edit temperature 1 groups or the R4 soft key to edit temperature 2 groups (Figure 29, page 17).
3. Select the group that contains the item(s) you want to edit.
4. Select a food item.
5. Select a quantity (high-capacity menus only).
6. From the “Recipe Edit” screen (Figure 30, below), edit the food group name:
 - Use the number keys to change a character.
 - Press the R1 soft key to advance to the next character.
 - Press the L1 soft key to return to the previous character.
 - Press the R3 soft key to save changes.
7. Edit the recipe name:
 - Press the Down key to move to the “Recipe Name” field.
 - Use the instructions provided in step 6 to edit the recipe name.
8. If applicable, edit the quantity name:
 - Press the Down key to move to the “Quantity Name” field.
 - Use the instructions provided in step 6 to edit the quantity name.
9. Press the R3 soft key to save changes. For additional editing options, see adjacent.

Changing Cook Settings

To change cook settings,

1. Follow the steps in *Changing Food Group/Item Name*, adjacent.
2. Use the number keys to adjust event settings:
 - % Time (0-100% in 1% increments). The sum of the percentages across six events must equal 100.
 - % Top Blower (10-100% in 10% incr.)
 - % Bottom Blower (10-100% in 10% incr.)
 - % Microwave (0-100% in 10% incr.)
3. Use the Down key to move the cursor to the “Warm Time” field.

NOTE: For ease of navigation, the R4 “Time” soft key jumps the cursor to the warm time field.

4. Use the number keys to adjust the cook time.
5. Press the R3 soft key to save changes.

NOTE: For the save to take effect, the cursor must be advanced past the field that was last edited.

6. If desired, press the R5 soft key to test-cook the new settings. In doing so, the oven may require additional warmup time.
7. When all editing is complete, return to the Set Options screen and turn off the Edit Mode (see page 15). This will allow access to the regular cook mode.

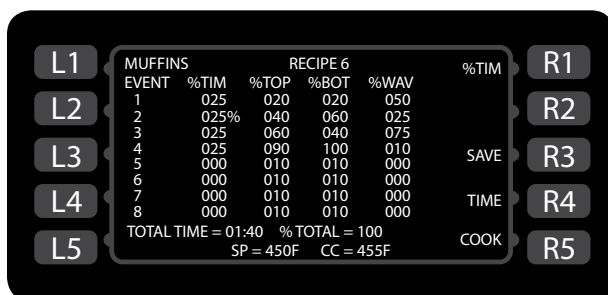



Figure 30: Food Item Edit Screen

Troubleshooting

The following is a list of fault codes and error messages, along with the possible problem(s) that the oven may be experiencing. If you experience one of these issues, please attempt the recommended action before calling Customer Support (800.90TURBO, +1 214.379.6000). If a fault code, error message, or problem occurs that does not appear on this list, contact Customer Support.

NOTE: Any fault codes listed in **bold** will terminate a cook cycle upon discovery. F6 will not terminate a cook cycle; however, it will alert the user of a possible air circulation problem.

 **WARNING:** Food, oven door, and oven cavity are hot! Use extreme caution when troubleshooting the issues below.

Issue	Possible Cause(s)	Resolution
No power to oven.	<ul style="list-style-type: none"> - Oven is not plugged in. - Main circuit breaker is tripped. 	<ul style="list-style-type: none"> - Plug oven in. - Verify wall circuit breaker is on. Reset breaker and then power oven back on.
Oven is not warming up properly.	<ul style="list-style-type: none"> - Oven is in OFF state. - Door is not closed. - Oven has been switched off at the main circuit breaker. - High-limit thermostat tripped 	<ul style="list-style-type: none"> - Press the “On/Off” soft key. - Close the cook cavity door. - Place the oven in the OFF state and unplug the oven – leave for two minutes. Re-plug in the oven, switch on the isolator/main power supply, and press “On/Off” key. - Press the button located in the bottom-left corner of the oven rear wall to reset the high-limit thermostat.
Display reads “Oven Door Open” and alarm sounds.	<ul style="list-style-type: none"> - Food obstruction preventing door from closing. - Oven door is open. - Door switches are out of alignment. 	<ul style="list-style-type: none"> - Open door and remove obstruction. - Open and close the door several times. - Call Customer Support.
Oven is not cooking properly.	<ul style="list-style-type: none"> - Oven is not clean. (Large deposits of grease, carbon, or debris dilute the microwave.) - Incorrect group and/or item name was selected for the product. - Product was not cooked from correct starting state (for example, room temperature instead of frozen). - Rack incorrectly positioned (i5 oven only). - Lower air diverter is missing. 	<ul style="list-style-type: none"> - Clean the oven following the cleaning instructions on pages 7-9. - Check to make sure correct food group and/or item was selected for the product being cooked. - Ensure product was in the correct state before being placed in the oven. - Verify the rack is in the correct position. - Verify the air diverter is installed properly (pages 7-9).

Issue	Possible Cause(s)	Resolution
F1: Blower Running Status Bad	<ul style="list-style-type: none"> - Oven power interrupted. - Blower motor not running. 	<ul style="list-style-type: none"> - Verify wall circuit breaker is on. Reset the breaker and then power the oven on. - Place the oven in the OFF state and unplug the oven – leave for two minutes. Re-plug in the oven, switch on the isolator/main power supply, and press the “On/Off” soft key. - Call Customer Support.
F2: Cook Temperature Low	<ul style="list-style-type: none"> - Oven power interrupted. - Air nozzles on the top/bottom of the cook cavity are clogged. - Oven door is out of alignment. - Defective heater. - Blower motor not running. - Oven not fully warmed up. 	<ul style="list-style-type: none"> - Verify wall circuit breaker is on. Reset the breaker and then power oven back on. - Open oven door and verify the air nozzles on the top/bottom of the cook cavity are clean and not clogged. - Open and close the door several times and verify oven door is closed. - Reset high-limit located in the bottom left corner of the oven rear wall. If the problem persists, call Customer Support. - Call Customer Support. - Repeat warmup and allow oven to idle for five minutes.
F3: Magnetron Current Low	<ul style="list-style-type: none"> - Microwave circuit defective. 	<ul style="list-style-type: none"> - Call Customer Support.
F4: Door Monitor Defective	<ul style="list-style-type: none"> - Oven door switches are out of order. 	<ul style="list-style-type: none"> - Call Customer Support.
F5: Magnetron Over Temperature	<ul style="list-style-type: none"> - Blockage of cool air into the oven. - Rear cooling fan exhaust guard(s) clogged. 	<ul style="list-style-type: none"> - Remove anything that may be obstructing the flow of cool air into the oven. - Check rear fans to see if they are free of debris. Clean as required.
F6: EC Temp	<ul style="list-style-type: none"> - Blockage of cool air into the oven. - Rear cooling fan exhaust guard(s) clogged. 	<ul style="list-style-type: none"> - Remove anything that may be obstructing the flow of cool air into the oven. - Check rear fans to see if they are free of debris. Clean as required.

North America Limited Warranty

TurboChef “i5” and “i3” Rapid Cook Oven – North America

The TurboChef rapid cook oven Limited Warranty outlined below is activated upon shipment of your oven. Should you require additional assistance after reviewing the warranty outlined below, please call TurboChef Customer Support at 800.90TURBO.

Limited Warranty

TurboChef Technologies, Inc. (“TurboChef”) warrants to you, the purchaser, that under normal use the TurboChef rapid cook oven you have purchased (the “Equipment”) will be free from defects in material and workmanship during the Warranty Period, subject to the terms and conditions set forth herein. The “Warranty Period” is twelve (12) months from the date the Equipment is shipped from TurboChef’s U.S. factory or distribution center. This warranty is conditioned upon you promptly notifying TurboChef of any claims, as provided in the paragraph entitled “Warranty Claims” below, and providing TurboChef with all data and information requested by TurboChef or its service agents in connection with such claims as well as all necessary access to your premises and the Equipment. This warranty is made only to the initial purchaser of the Equipment from TurboChef or its authorized dealer; it is not assignable to subsequent purchasers unless TurboChef consents to such assignment in writing.

Disclaimer of Warranties

Except as provided in the Limited Warranty above, the Equipment is provided “as-is”. TurboChef disclaims all other warranties, express, statutory or implied, including without limitation, the implied warranties of title, non-infringement, merchantability and fitness for a particular purpose. TurboChef does not warrant that the Equipment will meet your specifications or needs. You acknowledge that you are solely responsible for the selection of the Equipment and determining the suitability of the Equipment for your needs.

Warranty Exclusions

Improper Installation, Operation or Maintenance: Equipment that is not installed, operated and maintained in accordance with TurboChef’s rapid cook oven owner’s manual (as may be updated by TurboChef from time to time, the “Manual”), a copy of which is provided to you with the Equipment or otherwise will be furnished to you upon request, is excluded from this warranty. This warranty does not apply to damage or failure which results, in TurboChef’s or its service agent’s sole opinion, from failure to provide a suitable installation and operating environment (including power and HVAC) and facilities as prescribed by the Manual, misuse, abuse, accident, neglect, power failure or power surges (over or under voltage), or to damage or failure from flood, fire, lightning or other natural or man-made disasters, or other Acts of God, or to Equipment that has missing or altered serial numbers.

Modifications and Repair: Equipment that has been modified or altered by persons other than TurboChef or its service agents, or Equipment that has had non-approved devices or connection items attached thereto, is excluded from coverage under this warranty. Repair of the Equipment by anyone other than TurboChef or its authorized service agents will void all warranties on the Equipment.

Accessories: Accessories and parts (collectively “Accessories”) that are consumed in the normal course of Equipment operation or maintenance are excluded from this warranty. Failure of or damage to Equipment or components from the use of non-approved cleaning chemicals, devices or processes is also excluded from this warranty. Accessories may include, but are not limited to, ceramic cooking platters, paddles and approved cleaning chemicals and devices.

Outstanding Invoices: If the full invoiced amount for Equipment purchased has not been paid within forty-five (45) days from the invoice date, then TurboChef will have no obligation to honor this or any other warranty on the Equipment until payment is received in full, including any accrued interest or other charges, has been satisfied, at which time warranty coverage will be reinstated, but the Warranty Period will not be extended.

Required Upgrades

At any time during the Equipment’s warranty period, TurboChef reserves the right to perform any upgrade that TurboChef deems necessary to the Equipment, whether reactively, i.e., at the time of the next opportune servicing as defined by TurboChef, or proactively, i.e., at any time TurboChef deems necessary. These upgrades include, but are not limited to, any upgrade that ensures the proper, reliable, and safe operation of the Equipment. If any upgrade is refused by the customer, TurboChef reserves the right to, from the date of refusal, void the Equipment’s remaining warranty period.

Warranty Service, Exclusive Remedy

TurboChef will be solely responsible for determining whether or not the Equipment or any component thereof is defective. Defective components covered by this warranty will be repaired or replaced at TurboChef's option without charge to you and such repaired or replacement components will be covered by this warranty for the balance of the Warranty Period. Parts used in the repair of defective components and replacement components may be new, recovered or rebuilt. At its sole option, TurboChef may decide to replace defective Equipment covered by this warranty with new, recovered or rebuilt Equipment of equal or greater capability, and such Equipment will be covered by this Limited Warranty for the balance of the Warranty Period. Defective Equipment and components will become the property of TurboChef. This paragraph states TurboChef's sole and exclusive obligation and liability and your sole and exclusive remedy under this warranty. TurboChef shall not be responsible for a failure to provide warranty services due to causes beyond TurboChef's or its service agents' control.

Warranty Claims

Claims under this warranty must be reported to TurboChef during our normal working hours at 800.90TURBO, or such other reporting service as TurboChef may designate. Upon receipt of the claim and related information and preliminary verification that the claim is valid, TurboChef will promptly notify an authorized service agent to contact you and arrange for an on-site repair visit during the service agent's normal working hours. Any costs incurred by TurboChef or its service agent associated with a service agent being refused or unable to gain access to the Equipment on your premises, or a claim not covered by this warranty, will be charged to you.

Disclaimer of Damages

TurboChef disclaims all incidental, special and consequential damages, including but not limited to loss of use, lost revenue or profits, or substitute use, suffered by you or any third party, whether arising in contract, tort (including negligence), or otherwise, resulting from any breach by TurboChef or its service agents of this warranty, or resulting from the manufacture, use, or defects, of or in the Equipment, even if TurboChef was apprised of the possibility of such damages.

Customer Indemnity

You agree to indemnify, defend and hold TurboChef harmless from all third party claims, demands, judgments, fees and costs directly or indirectly arising out of or related to your use of the Equipment. You further agree to indemnify and hold TurboChef harmless from any incidental, consequential or special damages suffered by you, including lost revenue or profits, loss of use, or substitute use, during periods of Equipment failure or loss of use.

Territory

This warranty is valid in the United States of America, Canada and Puerto Rico.

Governing Law, Entire Warranty

This warranty shall be governed and construed in accordance with the laws of the State of Georgia, USA (except with respect to its provisions regarding conflicts of laws). The warranty described herein is the complete and only warranty for Equipment and supersedes all prior oral or written agreements and understandings that may have existed between us relating to Equipment warranties. The terms of this warranty may not be altered, amended or modified except by a signed writing from TurboChef. Any purported alteration, amendment or modification by a service agent or anyone else will not be enforceable against TurboChef.

Charges for Non-Warranty Service or Rejection of Service Visit

In the event that repairs, replacement or service are provided by TurboChef's service agents for work not covered by this limited warranty, customer agrees to pay the service agent directly according to the service agent's normal scale of charges. In the event TurboChef is invoiced by the service agent for services not covered under this extended warranty, TurboChef will invoice customer and customer will pay such invoice based on terms of net 10 days. Customer also agrees to pay any cost incurred by TurboChef or its service agent associated with a service agent responding to a call for service, but then being refused or unable to gain access to the Oven on Customer's premises. Failure to submit payment may, at TurboChef's discretion, result in TurboChef voiding the balance of the warranty. In no event will TurboChef authorize service to a store with an outstanding Non-Warranty invoice.

International Limited Warranty

This Limited Warranty shall apply to the sales of all TurboChef “i5” and “i3” Series ovens (the “Equipment”) manufactured by TurboChef Technologies, Inc. (“TurboChef”), and sold to purchasers outside of the United States, Canada, Puerto Rico, Central and South America by an Authorized Distributor of TurboChef International (the “Authorized Distributor”).

Limited Warranty

You, the purchaser (“You”) have entered into a sales contract with the Authorized Distributor for the purchase of the Equipment. This Limited Warranty is made to you by the Authorized Distributor from whom you purchased the Equipment with the support of TurboChef. Subject to the limitations stated below, the Authorized Distributor warrants to You that the quantity and specification of the Equipment delivered to You shall be as set out in the Authorized Distributor’s acceptance of your order and that the Equipment will be free from any material defects in the product and workmanship for twelve (12) months from the date of installation (the “Warranty Period”), subject to the terms and conditions set forth herein.

Disclaimer

You acknowledge that You are solely responsible for the selection of the Equipment and determining the suitability of the Equipment for Your needs. All other warranties, conditions or terms relating to fitness for purpose, quality or condition of the Equipment, whether expressed or implied by statute or common law or otherwise are excluded to the fullest extent permitted by law.

The TurboChef Global Warranty System

This Limited Warranty commences upon delivery of the Equipment to Your premises. The Authorized Distributor will inspect and install the Equipment at Your premises in accordance with TurboChef’s instructions and will record the serial number of the Equipment, Your contact details, the date and location of installation and the results of the Authorized Distributor’s inspection. This information will be entered by the Authorized Distributor into the TurboChef global warranty system and will be used by TurboChef, the Authorized Distributor and its authorized service agents for the provision of the warranty service.

Required Upgrades

At any time during the Equipment’s warranty period, TurboChef reserves the right to perform any upgrade that TurboChef deems necessary to the Equipment, whether reactively, i.e., at the time of the next opportune servicing as defined by TurboChef, or proactively, i.e., at any time TurboChef deems necessary. These upgrades include, but are not limited to, any upgrade that ensures the proper, reliable, and safe operation of the Equipment. If any upgrade is refused by the customer, TurboChef reserves the right to, from the date of refusal, void the Equipment’s remaining warranty period.

Warranty Service

During the Warranty Period, any materially defective Equipment will be repaired or replaced free of charge at TurboChef’s option provided that:

1. You notify the Authorized Distributor from whom You purchased the Equipment and/or TurboChef as soon as reasonably possible after discovery of a defect and in accordance with the warranty claims procedure set out below;
2. You provide the Authorized Distributor from whom You purchased the Equipment and/or TurboChef with all data and information reasonably requested by TurboChef, the Authorized Distributor or its authorized service agents in connection with Your warranty claim;
3. You make the Equipment available to TurboChef, the Authorized Distributor or its authorized service agents;
4. The Equipment has been installed by an Authorized Distributor and you have provided all necessary information for the Authorized Distributor to register the Equipment in the TurboChef global warranty system;

5. The Equipment has been operated and maintained by You in accordance with TurboChef's "Owner's Manual" provided with the Equipment (and as updated by TurboChef);
6. You have not used any non-approved devices, accessories, consumables or parts in conjunction with the Equipment; and
7. Repairs, modifications or alterations have not been attempted other than by TurboChef, an Authorized Distributor or its authorized service agent.

Neither TurboChef nor the Authorized Distributor assumes any liability for damage caused by Your failure to provide a suitable installation and operating environment (including power and HVAC) or facilities as prescribed by the Manual, misuse or abuse or by accident, neglect, power failure or power surges (over or under voltage) howsoever arising.

At its sole option, TurboChef may replace defective Equipment or components with new, recovered or rebuilt Equipment of equal or greater capability, and such Equipment or components will be warranted by the Authorized Distributor for the balance of the Warranty Period. Replaced defective Equipment or components will become the property of TurboChef.

Warranty Claims: Any warranty claim must be made directly in writing either to the Authorized Distributor from whom You purchased the Equipment or to TurboChef at the following address:

TurboChef Technologies, Inc.
2801 Trade Center Drive
Carrollton, Texas 75007
Phone: +1 214-379-6000
Fax: +1 214-379-6073

The claim must include the serial number of the Equipment and be received by TurboChef on or before the last day of the Warranty Period. Upon receipt of Your claim, TurboChef will promptly notify an Authorized Distributor or an authorized service agent to contact You, to verify Your claim and, if necessary, to arrange for an on-site repair visit during normal working hours.

Consumables and Parts Used with The Equipment: Neither TurboChef nor the Authorized Distributor assumes any liability for consumables and parts that are used in the normal course of Equipment operation or for failure of or damage to Equipment or components from the use of non-approved cleaning chemicals, devices or processes.

Charges for Service Not Covered by Limited Warranty: In the event that You request and receive repairs, replacement or service not covered by this Limited Warranty, You will be invoiced and must pay the Authorized Distributor or authorized service agent directly according to its normal scale of charges and business terms.

Product Liability: Neither TurboChef nor the Authorized Distributor assumes any liability for any incidental, special or consequential damages, including but not limited to loss of use, lost revenue or profits, or substitute use suffered by You or any third party, whether arising in contract, tort (including negligence), or otherwise resulting from any breach by TurboChef or the Authorized Distributor of the Limited Warranty provided herein.

Exclusive Remedy: This Limited Warranty states the Authorized Distributors and TurboChef's sole and exclusive obligation and liability and your sole and exclusive remedy under this Limited Warranty.

Third Party Rights: The UK Contract (Rights of Third Parties) Act 1999 is excluded from applying to this Limited Warranty and nothing herein confers or purports to confer on any third party any benefit or any right to enforce any term of this Limited Warranty.

Severability: If any item or provision contained in this Limited Warranty or any part of them ("an offending provision") is declared to be or becomes unenforceable, invalid or illegal for any reason whatsoever in any jurisdiction, the other terms and provisions of this Limited Warranty shall remain in full force and effect in that jurisdiction as if it had been executed without the offending provision appearing in it and the entire Limited Warranty shall remain in full force and effect in all other jurisdictions.

Governing Law, Entire, Agreement: This Limited Warranty shall be governed by and construed according to English law. The application of the United Nations Convention on International Sale of Goods to this Limited Warranty is expressly excluded. This Limited Warranty may not be altered, amended or modified by the Authorized Distributor or its service agent, and no representation, alteration, amendment or modification by TurboChef shall be valid unless in a signed form from TurboChef.

For service or information:

WITHIN NORTH AMERICA CALL

Customer Support *at* 800.90TURBO

OUTSIDE NORTH AMERICA CALL

+1 214.379.6000 or Your Authorized Distributor



Global Operations

2801 Trade Center Drive
Carrollton, Texas 75007 USA
+1 214-379-6000 PHONE
+1 214-379-6073 FAX

Customer Support

1-800-90TURBO
+1 214-379-6000
turbochef.com