



GEMO650 ON IOD200

Features

- Space-saving 21" (533 mm) wide design.
- Produces up to 770 lbs (349 kg) of ice per day.
- Pearl Ice® soft, chewable ice crystals.
- Cools beverages faster and longer while maintaining flavors better.
- Decreased water and power usage compared to cube ice makers.
- SystemSafe load monitoring system constantly checks workload on gearbox, shutting down system before a problem develops and preventing costly repairs.
- Water Sensor eliminates low or no water failures and cannot be affected by adverse water conditions.
- Rugged stainless steel evaporator and auger ensures reliability.
- Industrial-grade roller bearings and heavy-duty gearbox provide years of trouble-free service.

GEMO650/O655 PEARL ICE® MAKER

Options & Accessories

WATER FILTERS			
Ice Machine Model	Manifold		Inline
	System	Replacement	System
GEMO650	IFQ1	IOMQ (1)	N/A
GEMO655			

Ice Maker Warranty

Every Ice-O-Matic ice maker is backed by a warranty that provides both parts and labor coverage.

- Three years **Parts** and **Labor** for all Pearl Ice® ice maker parts.
- Five years **Parts** coverage on the compressor.

Ice Form



PEARL ICE

PEARL ICE DIMENSIONS

H x Dia. (in.)	1/2 x 3/8
H x Dia. (mm)	12.7 x 9.5

Bin Chart Kits for Combining Wider Bins with Smaller Models

ICE STORAGE BINS											
Kits	Model No.	B25	B40	B42	B55	B70-30	B90-30	B100	B120	B150	B170
	Capacity Width	242 lbs (110 kg) 30 in (762 mm)	344 lbs (156 kg) 30 in (762 mm)	351 lbs (160 kg) 22 in (559 mm)	510 lbs (232 kg) 30 in (762 mm)	741 lbs (337 kg) 30 in (762 mm)	1023 lbs (465 kg) 30 in (762 mm)	854 lbs (388 kg) 48 in (1219 mm)	1142 lbs (519 kg) 48 in (1219 mm)	1447 lbs (658 kg) 60 in (1524 mm)	1807 lbs (821 kg) 60 in (1524 mm)
	GEMO650	KBT19		KBT24	KBT19	N/A		KBT23		N/A	
	GEMO650 (2)	N/A						KBT22			
	GEMO655	KBT19		KBT24	KBT19			KBT23			
	GEMO655 (2)	N/A						KBT22			

*See Ice-O-Matic Price List for Adapter Kits to combine ice makers with most available ice/beverage dispensers



Air Cooled

Please note: air-cooled units require 6" (152 mm) clearance for air intake and exhaust.

- A. Ice maker potable water in, 3/8" FPT.
- B. Ice maker water out, 3/4" FPT.
- C. Electrical inlet.

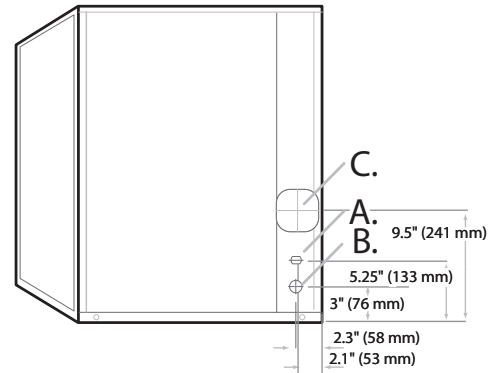
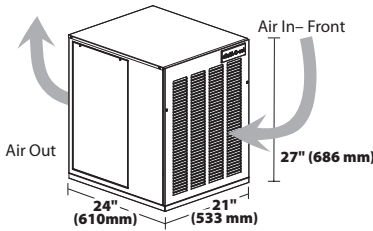

Rear View Air Cooled

Water Cooled/Remote

- A. Ice maker water in, 3/8" FPT.
- B. Ice maker water out, 3/4" FPT.
- C. Electrical inlet.
- D. Condenser water in, 3/8" (water cooled only).
- E. Condenser water out, 1/2" (water cooled only).
- F. Liquid line, 3/8" male coupling for precharged line set (remote only).
- G. Discharge line, 1/2" male coupling for precharged line set (remote only).
- H. Remote condenser junction box (remote only).

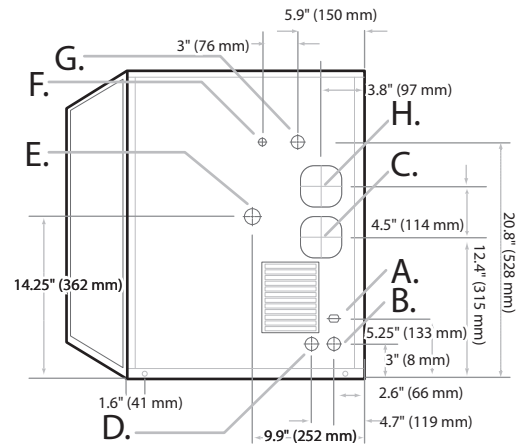

Rear View Water Cooled & Remote

Operating Requirements

	MINIMUM	MAXIMUM	
		60 Hz	50Hz
Ambient Temp. Range Air	50°F (10°C)	100°F (38°C)	
Water Temp.	40°F (4.4°C)	100°F (38°C)	
Water Pressure	20 PSIG (1.4 BAR)	120 PSIG (8.3 BAR)	
Remote Cond. Temps	-20°F (-29°C)	120°F (50°C)	

Dimensions

ALL MODELS	
W x D x H (in.)	21 x 24 x 27
W x D x H (mm)	533 x 610 x 686

Specifications

Model Number	Cond. Unit	Ice Production per 24hrs		Water Usage gallons per 100 lbs (45 kg) of ice		kWH Used per 100 lbs (45 kg) of ice @ 90°F (32°C) air/70°F (21°C) water	Voltage Characteristics	Min. Circuit Ampacity	Fuse Size	Approx. BTUs per hour**
		70°F (21°C) air/50°F (10°C) water lbs (kg)	90°F (32°C) air/70°F (21°C) water lbs (kg)	Potable	Condenser					
GEMO650A	Air	740 (336)	550 (249)	12.0	-	5.31	115/60/1	21.0	30	5,600
GEMO650W	Water	770 (349)	633 (287)		115	3.4				
GEMO650R	Remote*	770 (349)	600 (272)		-	6.01		23.5		
GEMO655A	Air	665 (302)	494 (224)		87.5	3.7	230/50/1	10.1	15	4,400
GEMO655W	Water	699 (317)	578 (262)					9.5		

*Requires Remote GRC 1001 Condenser. **BTUH is calculated 0°F Evaporator, 100°F Condensing, and 33 PSIG.

NOTES:

Number of Wires: 3 (including ground)
 Approx. Shipping Weight lbs (kg): GEMO650A 205 (93) • GEMO650W 220 (100) • GEMO650R 220 (100) • GEMO655A 205 (93) • GEMO655W 200 (91)
 Refrigerant Type: R404A