



GAS

PRO SERIES | 60" RANGES

IMPERIAL



IR-10

Shown with optional casters.

STANDARD OVENS

- Linear burner provides even heating throughout the oven.
- Unique burner baffle distributes heat flow to provide even temperatures throughout the oven cavity.
- Exclusive heat deflector reflects heat into the oven, not the floor. 100% safety pilot.
- Chef Depth interior is 26-1/2" w x 26" d x 14" h (673 w x 660 d x 356 h mm) and accommodates 18" x 26" (457 x 660 mm) sheet pans left-to-right and front-to-back. Chef Depth is 35,000 BTU (10 KW).
- Porcelainized sides, rear, deck and door lining for easy cleaning. Heavy duty door hinge.
- Stamped inner door liner provides extra strength while optimizing heat retention.
- One chrome oven rack is included.

CONVECTION OVENS

- 30,000 BTU/hr. (9 KW) convection oven with 1/2 hp blower motor cooks products quickly and evenly with less shrinkage.
- Convection oven interior dimensions 26-1/2" w x 22-1/2" d x 14" h (673 x 572 x 356 mm).
- Three position switch for cooking or cool down. Fan shuts off automatically when door is open.
- Porcelainized sides, rear, deck and door lining for easy cleaning. Heavy duty door hinge.
- Three chrome oven racks are included.
- Electronic ignition system with electronic timer countdown.

Notes:

"CC" specifies: (2) 26-1/2" (673 mm) Convection Ovens "C-XB" specifies: (1) 26-1/2" (673 mm) Convection Oven

"C" specifies: (1) 26-1/2" (673 mm) Convection Oven

(1) 26-1/2" (673 mm) Standard Oven

"XB" specifies: (1) 26-1/2" (673 mm) Standard Oven
(1) Cabinet Base

"G" specifies: Griddle Top, griddle on left is standard

"RG" specifies: Raised Griddle Top, raised griddle on right is standard

Model Numbers

IR-10	IR-4-G36	IR-G60
IR-10-C	IR-4-G36-C	IR-G60-C
IR-10-CC	IR-4-G36-CC	IR-G60-CC
IR-10-XB	IR-4-G36-XB	IR-G60-XB
IR-10-C-XB	IR-4-G36-C-XB	IR-G60-C-XB
IR-6-G24	IR-2-G48	IR-6-RG24
IR-6-G24-C	IR-2-G48-C	IR-6-RG24-C
IR-6-G24-CC	IR-2-G48-CC	IR-6-RG24-CC
IR-6-G24-XB	IR-2-G48-XB	IR-6-RG24-XB
IR-6-G24-C-XB	IR-2-G48-C-XB	IR-6-RG24-C-XB

OPEN BURNERS

- PyroCentric™ 32,000 BTU (9 KW) anti-clogging burner with a 7,000 BTU/hr. (2 KW) low simmer feature. Two rings of flame for even heating.
- Cast iron PyroCentric burners are standard on all IR Series Ranges.
- Burners are anti-clogging and lift-off and separate for easy cleaning. No gaskets or screws.
- One standing pilot per burner for instant ignition.



ROUND STAINLESS STEEL "CHEFS" HANDLE

GRATES

- Front grates measure 12" x 12" (305 x 279 mm). Back grates are 12" x 13" (305 x 330 mm).
- Back grates are sized for positioning large stock pots directly over burner and feature a hot air dam.
- Pots slide easily from section to section and onto landing ledge.
- Grates are cast iron for a long service life.
- All stainless steel upper burner box, top grate supports front and rear.



NEW TWO PIECE TOP GRATE DESIGN

GRIDDLE/RAISED GRIDDLE OPTIONS

- Highly polished 3/4" (19 mm) steel plate. 21" (533 mm) plate depth.
- Burners have 20,000 (6 KW) BTU/hr. output with a heat deflector every 12" (305) for even heating.
- 3" (76 mm) wide grease trough and removable grease can for easy cleaning.
- Large griddle grease can and full width broiler drip tray are removable for easy cleaning.

Measurements in () are metric equivalents.





GAS

PRO SERIES | 60" RANGES

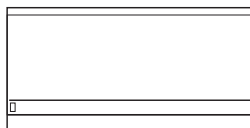
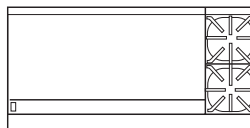
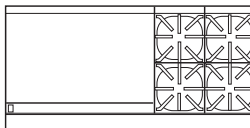
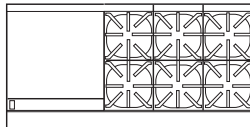
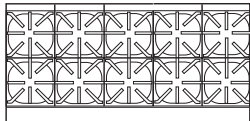
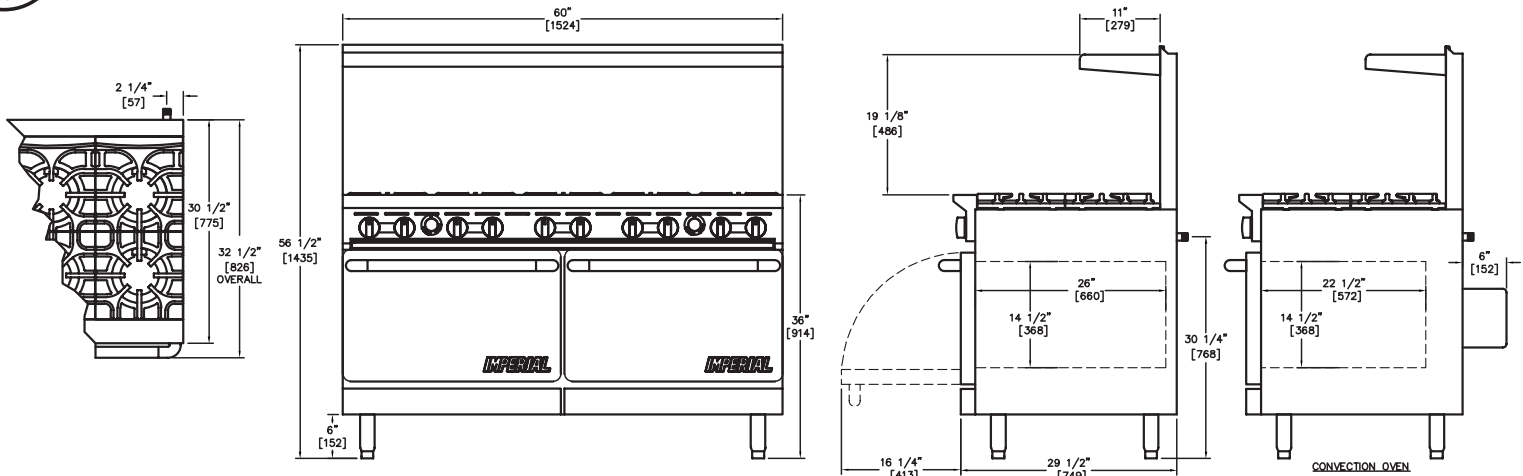

RAISED GRIDDLE

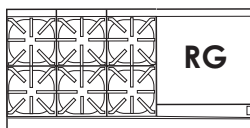

MODEL	GAS OUTPUT		OPEN BURNERS	GRIDDLE WIDTH	SHIP WEIGHT	
	BTU	KW			KG	LBS
IR-10	390,000	114	10	N/A	444	889
R-10-C	385,000	113	10	N/A	468	1,035
IR-10-CC	380,000	111	10	N/A	493	1,090
IR-10-XB	355,000	104	10	N/A	425	940
IR-10-C-XB	350,000	103	10	N/A	451	995
IR-6-G24	302,000	89	6	24" (610 MM)	480	1,060
IR-6-G24-C	297,000	87	6	24" (610 MM)	506	1,115
IR-6-G24-CC	292,000	86	6	24" (610 MM)	530	1,170
IR-6-G24-XB	267,000	78	6	24" (610 MM)	457	1,010
IR-6-G24-C-XB	262,000	77	6	24" (610 MM)	483	1,065
IR-4-G36	258,000	76	4	36" (914 MM)	491	878
IR-4-G36-C	253,000	74	4	36" (914 MM)	517	1,140
IR-4-G36-CC	248,000	73	4	36" (914 MM)	540	1,195
IR-4-G36-XB	223,000	65	4	36" (914 MM)	468	1,035
IR-4-G36-C-XB	218,000	64	4	36" (914 MM)	494	1,090
IR-2-G48	214,000	63	2	48" (1219 MM)	496	1,095
IR-2-G48-C	209,000	61	2	48" (1219 MM)	522	1,150
IR-2-G48-CC	204,000	60	2	48" (1219 MM)	540	1,195
IR-2-G48-XB	179,000	52	2	48" (1219 MM)	472	1,045
IR-2-G48-C-XB	174,000	51	2	48" (1219 MM)	499	1,100
IR-G60	170,000	50	N/A	60" (1524 MM)	505	1,115
IR-G60-C	165,000	48	N/A	60" (1524 MM)	531	1,170
IR-G60-CC	160,000	47	N/A	60" (1524 MM)	554	1,225
IR-G60-XB	135,000	40	N/A	60" (1524 MM)	483	1,065
IR-G60-C-XB	130,000	38	N/A	60" (1524 MM)	508	1,120
IR-6-RG24	302,000	89	6	24" (610 MM)	496	946
IR-6-RG24-C	297,000	87	6	24" (610 MM)	522	1,150
IR-6-RG24-CC	292,000	86	6	24" (610 MM)	540	1,195
IR-6-RG24-XB	267,000	78	6	24" (610 MM)	468	1,035
IR-6-RG24-C-XB	262,000	77	6	24" (610 MM)	499	1,100

EXTERIOR

- Stainless steel front, sides, backguard, shelf, landing ledge and kick plate
- Welded and polished stainless steel seams
- Large 3.5" (127 mm) stainless steel landing ledge
- Control knobs are durable cast aluminum.
- Full width, removable crumb tray under open burners for easy cleaning
- 6" (152 mm) heavy duty legs with adjustable feet
- One year parts and labor warranty

OPTIONS AND ACCESSORIES

- Reinforcement channels for mounting cheese melter and salamander
- 6" and 11" (152 and 279 mm) stainless steel backguards. Stubbyback available
- 10" (254 mm) stainless steel wok ring
- Saute burner head, interchangeable
- Wok burner head, interchangeable
- 220V motor and transformer for convection oven
- Extra oven racks
- Thermostatic griddle control
- Grooved griddle plate
- Griddle safety valve
- Gas shut off valve 3/4" (19 mm)
- Quick disconnect and flexible gas hose
- 6" (152 mm) casters

CLEARANCE REQUIREMENTS

For use only on non-combustible floors. Legs or casters are required for non-combustible floors; or 2" (51 mm) overhang is required when curb mounted. Provide 0" clearance from non-combustible surfaces and 8" (203 mm) from combustible surfaces.

Crated Dimensions:

62-1/2" w x 39" d x 35" h (1588 x 991 x 889 mm)

Dimensions:

60" w x 31-1/2" d x 56-1/2" h (1524 x 800 x 1435 mm)

MANIFOLD PRESSURE		
NATURAL GAS	PROPANE GAS	MANIFOLD SIZE
5.0" W.C.	10.0" W.C.	3/4" (19 MM)

CONVECTION OVEN ELECTRICAL REQUIREMENT		
VOLTAGE	PHASE	AMPS
120	1	6

